

YAESU
The radio

HF/50MHz TRANSCEIVER

FT-710

Operation Manual

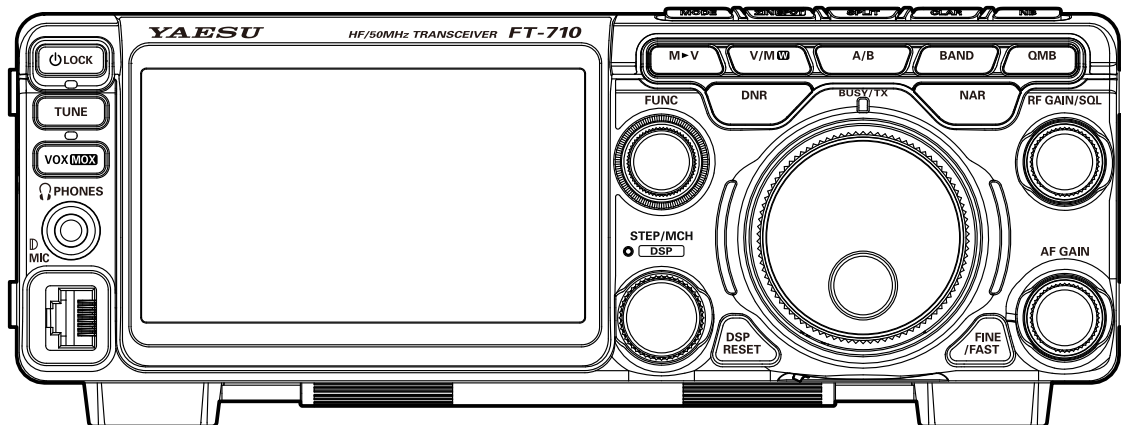

About this Manual

The FT-710 is a leading-edge transceiver with a number of new and exciting features, some of which may be unfamiliar to you. In order to gain the most enjoyment and operating efficiency from the FT-710, we recommend that you read this manual in its entirety, and keep it handy for reference as you explore the many capabilities of this new transceiver.

Before using the FT-710, be sure to read this manual.

How to read this operation manual

Two methods are used to select an item displayed on the FT-710 Function Screen: **“Operate by touching the item directly on the display”**; and **“Turn the [FUNC] knob to select the item and then press the [FUNC] knob”**.

Subsequently, in this manual, the operations that can be performed either by touching the Function Screen, or by turning and pressing the **[FUNC] knob** are abbreviated to **“Select [DISPLAY SETTING] → [DISPLAY] → [LED DIMMER]”**; as described in the following:

Example: How to adjust the brightness of the LED

1. Press the [FUNC] knob to display the function screen.
2. Touch [DISPLAY SETTING] on the function screen, or rotate the [FUNC] knob to select [DISPLAY SETTING] and then press the [FUNC] knob.
3. Touch [DISPLAY] on the display or rotate the [FUNC] knob to select [DISPLAY] and then press the [FUNC] knob.
4. Touch the setting section of [LED DIMMER] on the display, or rotate the [FUNC] knob to select [LED DIMMER] and then press the [FUNC] knob.
5. Rotate the [FUNC] knob, or touch “<” or “>” on either side of the value to adjust the brightness.

The following notations are also used in this manual:



This icon indicates cautions and alerts the user should be aware of.



This icon indicates helpful notes, tips and information.

Table of Contents

General Description	4	CURSOR.....	22
Safety Precautions	6	FIX.....	23
Accessories & Options	8	3DSS	23
Installation and Interconnections	9	MULTI.....	23
Antenna Considerations	9	EXPAND.....	24
Antenna Connections	9	SPAN.....	24
Power Cable Connections.....	9	SPEED	24
Microphone, Headphone, Key, Keyer and		Set with the FUNC knob.....	25
FH-2 Connections	10	LEVEL	25
Linear Amplifier Interconnections	11	PEAK.....	25
VL-1000 Linear Amplifier Interconnections....	11	MARKER.....	26
Display connections	12	COLOR.....	26
Remote operation (LAN unit "SCU-LAN10")		Adjust contrast.....	26
connection	12	Adjusting the brightness (DIMMER).....	26
AESS (Acoustic Enhanced		Other display settings.....	27
Speaker System).....	13	Screen Saver.....	27
SP-40 connections	13	Inputting the Call Sign	27
Rear Panel.....	14	Front Panel Controls & Switches.....	30
① TUNER/LINEAR	14	① ON/OFF (LOCK) Switch	30
② ANT.....	14	② SD memory card slot.....	30
③ GND.....	14	③ TUNE	30
④ EXT SPKR.....	14	④ VOX/MOX.....	30
⑤ REM/ALC.....	14	Adjusts the VOX GAIN	30
⑥ KEY.....	14	Adjusts the VOX Delay Time	30
⑦ RTTY/DATA	14	Adjusts the VOX anti-trip sensitivity	31
⑧ USB	14	⑤ PHONES Jack	31
⑨ USB Jack.....	14	⑥ MIC	31
⑩ EXT-DISPLAY.....	14	⑦ MAIN dial	31
⑪ DC IN.....	14	⑧ WIRE STAND	31
SSM-75E Microphone Switches	15	⑨ STEP • MCH / DSP	32
Display Indications.....	16	DSP interference removal functions.....	32
① Meter Display.....	17	1. SHIFT	33
② Operation MODE Display	17	2. WIDTH.....	33
③ Operation status Display	17	3. NOTCH.....	33
④ HI-SWR Display.....	17	4. CONTOUR	34
⑤ Frequency Display (VFO-A)	18	Adjusting the GAIN of the	
Keyboard Frequency Entry	18	CONTOUR Circuit.....	34
Tuning in 1 MHz or 1 kHz Steps.....	18	Sets the Bandwidth ("Q") of the	
⑥ Frequency Display (VFO-B)	18	CONTOUR Circuit.....	34
When the clarifier function is active.....	18	5. APF.....	34
⑦ Operation of the display [FUNC] knob.....	19	⑩ DSP RESET	34
⑧ Filter Function Display	20	⑪ DNR (Digital Noise Reduction).....	35
Turn the spectrum display OFF.....	20	Adjusting the DNR Level	35
⑨ Information displayed on the		⑫ A/B	35
scope screen	20	⑬ BAND (Operating Band Selection)	35
⑩ Important Receiver Settings	21	⑭ QMB (Quick Memory Bank).....	35
ATT (Attenuator).....	21	QMB Channel Storage	35
IPO	21	QMB Channel Recall.....	35
DNF (Digital NOTCH Filter).....	21	Changing the number of QMB channels..	35
AGC (Automatic Gain Control).....	21	⑮ VMI (VFO mode indicator).....	36
⑪ Information displayed on		⑯ BUSY/TX indicator.....	36
the scope screen.....	22	⑰ NAR (Narrow)	36
⑫ Scope Display Setting	22	⑱ FINE/FAST.....	36
CENTER/CURSOR/FIX	22	⑲ RF GAIN/SQL.....	37
CENTER.....	22	Switching the operation of the	
		[RF GAIN/SQL] knob.....	37

⑳ AF GAIN	37	DATA (FT8 / RTTY / PSK) Operation.....	56
㉑ MODE (Operating Mode Selection).....	37	Connecting to a Personal Computer	56
㉒ ZIN/SPOT	38	FT8 operation	57
㉓ SPLIT.....	38	RTTY Operation	58
㉔ CLAR (Clarifier)	38	PSK Operation	58
RX Clarifier	38	Memory Operation.....	60
Adjust transmit frequency to the		① M▶V.....	60
offset frequency.....	38	Moving Memory Data to the	
TX Clarifier	39	VFO register	60
To offset the frequency with the		Transfer last used memory to VFO	60
TX Clarifier Adjust receive frequency	39	② V/M 	60
㉕ NB.....	39	Memory Storage.....	60
Adjusting the Noise Blanker Level	39	Recall a Memory Channel other than	
Adjusting the Noise Attenuation	39	the last used VFO frequency.....	61
Reduces longer duration pulse noise.....	39	Memory Tune Operation.....	61
Voice Communications (SSB and AM)	40	Memory Groups.....	61
When transmitting in SSB or AM mode	40	Choosing the Desired Memory Group.....	61
Set with the FUNC knob.....	40	Erasing Memory Channel Data	62
Speech Processor	41	Check Memory Channel Status.....	62
RF Power output control.....	41	Labeling Memories.....	62
MONI (Monitor).....	41	Displaying the Memory Tag.....	62
Parametric Microphone Equalizer	42	Scan Skip Setting.....	63
Setup the	42	60-Meter (5 MHz) Band	
Parametric Microphone Equalizer	42	(U.S. and U.K. Version only)	63
Activate the	42	VFO and Memory Scanning	64
Parametric Microphone Equalizer	42	VFO/Memory Scan.....	64
Voice Memory.....	44	Programmable Memory Scan (PMS)	65
Record the received audio	45	Other Functions	66
Play the recorded content	45	Band Stack Operation	66
Erase the recorded content.....	45	TOT (Time Out Timer)	66
Adjustable Receiver Audio Filter	46	Operation on Alaska Emergency Frequency:	
Change the sound quality of the		5167.5kHz (U.S. Version Only)	66
received audio	47	Screen capture	67
Using the Automatic Antenna Tuner	48	Using the SD Card	68
CW Mode Operation.....	49	Formatting a SD card	68
Adjusting the Sidetone Audio level	49	Saving Memory data and Setting Menu data..	69
CW Delay Time Setting	49	Reading Memory and Set Menu data.....	70
CW Spotting (Zero-Beating)	49	Display the SD Card Information.....	70
Setting of the Electronic Keyer	50	Setting Menu	71
Adjusting the Keyer Speed.....	50	Optional Accessories	100
Setting the Keyer Weight (Dot/Dash) Ratio	50	FC-40 External Automatic Antenna Tuner	
Reversing the Keyer Polarity.....	50	(for Wire Antenna)	100
Selecting the Keyer Operating Mode	50	Active-Tuning Antenna System (ATAS-120A)..	102
Contest Memory Keyer.....	51	FH-2 Remote Control Switches.....	103
Message Memory.....	51	Carrying Handle MHG-1	104
Storing a Message into Memory.....	51	Mounting Bracket SMB-209	104
Message Memory Programming	51	Resetting the Microprocessor.....	105
(Using your Paddle).....	51	Specifications	106
Checking the CW Memory Contents	52	Index.....	108
On-The-Air CW Message Playback	52	YAESU LIMITED WARRANTY	110
TEXT Memory	53	Display the Certifications of	
Text Memory Storage	53	FCC and CANADA	112
Text Message Programming.....	53		
Checking the CW Memory Contents	54		
On-The-Air CW Message Playback	54		
FM Mode Operation.....	55		
Repeater Operation.....	55		
Tone Squelch Operation.....	55		

General Description

SDR receiver circuit designed with emphasis on fundamental performance

The high-resolution A/D converter and the FPGA element developed for the high-end SDR Yaesu Transceivers are utilized. The twin A/D converter circuit configuration performs digital conversion processing using two A/D converters and FPGA digital synthesis. A/D converter overflow due to overload is reduced to improve blocking characteristics. In addition, random noise is added to the analog signal before digital conversion, and by minimizing the quantization error during digital conversion by the A/D converter, distortion is suppressed. Then Dithering technology is implemented to improve IM (intermodulation) characteristics, etc., and enhance the overall performance of the SDR receiver circuit.

3DSS method adopted

In addition to the conventional waterfall display, a 3DSS (3 Dimensions Spectrum Stream) image method has been adopted. The 3DSS image uses the horizontal axis (X axis) for frequency, the vertical axis (Y axis) for signal intensity, and the Z axis for time. Compared to the conventional waterfall method, the signal strength is displayed in three dimensions as well as in color, recognition of changes in the band conditions is instant, convenient and intuitive.

AESS (Acoustic Enhancement Speaker System) produces high-fidelity Audio

Using DSP signal processing, the speaker in the top of the Transceiver, and an external side speaker are combined to reproduce high-quality received audio with a wide frequency range and a three-dimensional effect that would not be expected from a compact HF transceiver. Set the optimum sound quality by adjusting the output balance and frequency characteristics of the two speakers according to your preference.

High-brightness TFT full-color display with touch-panel functionality

The FT-710 is equipped with a 4.3-inch full-color TFT display. Operating functions, including the receiving band noise and signal interference reduction tools, are graphically displayed. Even while involved in rigorous operations, such as DXpeditions and contests, the operator may instantly grasp the status of each function.

Filter Function Display monitors the status of the passband

In the upper part of the display, a filter function display presents the state of the pass-band. In addition to the operating state of the interference removal functions, the filter function information is displayed. Not only can you grasp the operating status of WIDTH, SHIFT, NOTCH and CONTOUR at a glance, you can also view the status of the RF spectrum in the passband.

Two selectable RF Stages amplify the desired signals from low band to high band

RF amplifier AMP1, and AMP2 are low noise negative feedback RF amplifiers that may be selected or combined in series as is needed for various low-band, high-band, frequency and noise conditions.

In addition, the IPO (Intercept Point Optimization) function maximizes the dynamic range and enhances the close multi-signal and inter-modulation characteristics of the receiver. The influence of strong broadcasting stations, especially in the low bands, can be minimized.

WIDTH and the continuously variable Bandwidth SHIFT features permit elimination of interfering signals

The WIDTH feature allows the bandwidth to be narrowed by rotating the WIDTH knob. The SHIFT feature, can eliminate interference in one side of the passband. Often, weak signals disappear due to interfering signals (including pile-ups). The interfering signals may be extracted, leaving only the desired signal, because of the unique DSP sharp filtering characteristics.

CONTOUR feature is renowned for effective noise reduction

Rather than using the DSP extremely sharp attenuation characteristics, the CONTOUR circuit provides gentle shaping of the DSP passband filter, and can thus attenuate or peak bandwidth components in segments. The interfering signal can be naturally shaped without having part of the signal suddenly disrupted. The contour function is very effective in making the desired signal rise out of the interference.

DNR (Digital Noise Reduction) by DSP digital processing

The incorporated digital noise reduction circuit may be set to the optimal working algorithm by varying the 15 step parameters according to the noise type.

NOTCH feature can eliminate an unwanted heterodyne, and the DNF feature can instantly attenuate multiple heterodyne signals

When interfering beat signals are present in the receiver passband, the IF NOTCH feature can significantly eliminate a narrow portion of the passband and remove the interfering signal. Moreover, when there are multiple interfering signals, the DSP DNF (Digital Notch Filter) Automatic Tracking System can be effective, even when an interfering frequency is changing.

[FUNC] (function) knob

Simply press the function [FUNC] knob to easily select the setting menu, and then change the setting value. Quick response is possible even while operating. Assign a frequently used function or setting menu and then you can easily change the setting just by turning the knob.

VMI (VFO mode indicator)

The VMI is placed on the left and right sides of the MAIN dial to show the current operating status of VFO-A, VFO-B, Memory mode and clarifier/split operation.

The color of the VMI indicator may be selected from 4 colors (blue/green/red/white) for each operation status.

SD memory card

An SD card slot on the left side of the front panel permits using a commercially available SD memory card for recording/playback of received audio, for voice recording for transmission, to save the various operating settings, saving memory contents, and screen capture (saving the display screen). The SD card is also used to update the firmware.

Safety Precautions

Note beforehand that the company shall not be liable for any damages suffered by the customer or third parties in using this product, or for any failures and faults that occur during the use or misuse of this product, unless otherwise provided for under the law.

Type and meaning of the marks



DANGER

This mark indicates an imminently hazardous situation, which, if not avoided, could result in death or serious injury.



WARNING

This mark indicates a potentially hazardous situation, which, if not avoided, could result in death or serious injury.



CAUTION

This mark indicates a potentially hazardous situation, which, if not avoided, may result in minor or moderate injury or only property damage.

Type and meaning of symbols



Prohibited actions that must not be attempted, in order to use this radio safely. For example,  signifies that disassembly is prohibited.



Precautions that must be adhered to in order to use this radio safely. For example,  signifies that the power supply is to be disconnected.



DANGER



Do not use the device in “regions or aircrafts and vehicles where its use is prohibited” such as in hospitals and airplanes.

This may exert an impact on electronic and medical devices.



Do not use this product while driving or riding a motorbike. This may result in accidents.

Make sure to stop the car in a safe location first before use if the device is going to be used by the driver.



Do not transmit in crowded places in consideration of people who are fitted with medical devices such as heart pacemakers.

Electromagnetic waves from the device may affect the medical device, resulting in accidents caused by malfunctions.



Never touch the antenna during transmission.

This may result in injury, electric shock and equipment failure.



Do not operate the device when flammable gas is generated.

Doing so may result in fire and explosion.



When an alarm goes off with the external antenna connected, cut off the power supply to this radio immediately and disconnect the external antenna from this radio.

If not, this may result in fire, electric shock and equipment failure due to thunder.



Do not touch any liquid leaking from the liquid display with your bare hands.

There is a risk of chemical burns occurring when the liquid comes into contact with the skin or gets into the eyes. In this case, seek medical treatment immediately.



WARNING



Do not use voltages other than the specified power supply voltage.

Doing so may result in fire and electric shock.



Do not transmit continuously for long periods of time.

This may cause the temperature of the main body to rise and result in burns and failures due to overheating.



Do not dismantle or modify the device.

This may result in injury, electric shock and equipment failure.



Do not handle the power plug and connector etc. with wet hands. Also do not plug and unplug the power plug with wet hands.

This may result in injury, liquid leak, electric shock and equipment failure.



Do not use fuses other than those specified.

Doing so may result in fire and equipment failure.



When smoke or strange odors are emitted from the radio, turn off the power and disconnect the power cord from the socket.

This may result in fire, liquid leak, overheating, damage, ignition and equipment failure. Please contact our company customer support or the retail store where you purchased the device.



Keep the power plug pins and the surrounding areas clean at all times.

This may result in fire, liquid leak, overheating, breakage, ignition etc.









Disconnect the power cord and connection cables before incorporating items sold separately and replacing the fuse.





This may result in fire, electric shock and equipment failure.











Never cut off the fuse holder of the DC power cord.







This may cause short-circuiting and result in ignition and fire.

-  **Do not allow metallic objects such as wires and water to get inside the product.**
This may result in fire, electric shock and equipment failure.
-  **Do not place the device in areas that may get wet easily (e.g. near a humidifier).**
This may result in fire, electric shock and equipment failure.
-  **When connecting a DC power cord, pay due care not to mix up the positive and negative polarities.**
This may result in fire, electric shock and equipment failure.
-  **Do not use DC power cords other than the one enclosed or specified.**
This may result in fire, electric shock and equipment failure.
-  **Do not bend, twist, pull, heat and modify the power cord and connection cables in an unreasonable manner.**
This may cut or damage the cables and result in fire, electric shock and equipment failure.
-  **Do not pull the cable when plugging and unplugging the power cord and connection cables.**
Please hold the plug or connector when unplugging. If not, this may result in fire, electric shock and equipment failure.

-  **Refrain from using headphones and earphones at a loud volume.**
Continuous exposure to loud volumes may result in hearing impairment.
-  **Do not use the device when the power cord and connection cables are damaged, and when the DC power connector cannot be plugged in tightly.**
Please contact our company customer support or the retail store where you purchased the device as this may result in fire, electric shock and equipment failure.
-  **Follow the instructions given when installing items sold separately and replacing the fuse.**
This may result in fire, electric shock and equipment failure.
-  **Do not use the device when the alarm goes off.**
For safety reasons, please pull the power plug of the DC power equipment connected to the product out of the AC socket.
Never touch the antenna as well. This may result in fire, electric shock and equipment failure due to thunder.

CAUTION

-  **Do not place this device near a heating instrument or in a location exposed to direct sunlight.**
This may result in deformation and discoloration.
-  **Do not place this device in a location where there is a lot of dust and humidity.**
Doing so may result in fire and equipment failure.
-  **Stay as far away from the antenna as possible during transmission.**
Long-term exposure to electromagnetic radiation may have a negative effect on the human body.
-  **Do not wipe the case using thinner and benzene etc.**
Please use a soft and dry piece of cloth to wipe away the stains on the case.
-  **Keep out of the reach of small children.**
If not, this may result in injuries to children.
-  **Do not put heavy objects on top of the power cord and connection cables.**
This may damage the power cord and connection cables, resulting in fire and electric shock.
-  **Do not transmit near the television and radio.**
This may result in electromagnetic interference.
-  **Do not use optional products other than those specified by our company.**
If not, this may result in equipment failure.
-  **When using the device in a hybrid car or fuel-saving car, make sure to check with the car manufacturer before using.**
The device may not be able to receive transmissions normally due to the influence of noises from the electrical devices (inverters etc.) fitted in the car.

-  **Do not turn on the volume too high when using a headphone or earphone.**
This may result in hearing impairment.
-  **For safety reasons, switch off the power and pull out the DC power cord connected to the DC power connector when the device is not going to be used for a long period of time.**
If not, this may result in fire and overheating.
-  **Do not throw or subject the device to strong impact forces.**
This may result in equipment failure.
-  **Do not put this device near magnetic cards and video tapes.**
The data in the cash card and video tape etc. may be erased.
-  **Do not place the device on an unsteady or sloping surface, or in a location where there is a lot of vibration.**
The device may fall over or drop, resulting in fire, injury and equipment failure.
-  **Do not stand on top of the product, and do not place heavy objects on top or insert objects inside it.**
If not, this may result in equipment failure.
-  **Do not use a microphone other than those specified when connecting a microphone to the device.**
If not, this may result in equipment failure.

Accessories & Options

Supplied Accessories

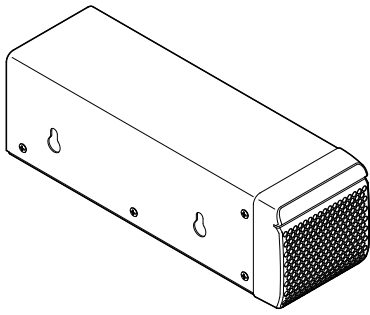

External Speaker SP-40

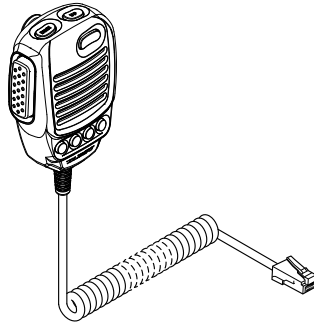

Hand Microphone SSM-75E

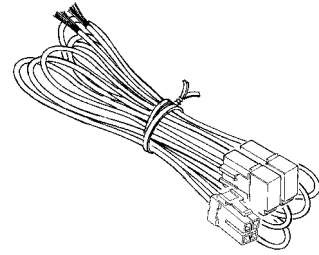

DC Power Cord

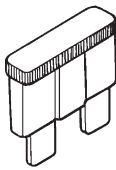

Spare Fuse (25A)

- Operation Manual
- World Map
- Sticker

Available options

- | | |
|---|-----------|
| • Hand Microphone (equivalent to the supplied microphone) | SSM-75E |
| • Reference Microphone | M-1 |
| • Dual Element Microphone | M-100 |
| • Desktop Microphone | M-90D |
| • Microphone Stand Kit | M-90MS |
| • Desktop Microphone | M-70D |
| • Lightweight Stereo Headphone | YH-77STA |
| • External Automatic Antenna Tuner | FC-40 |
| • Active Tuning Antenna (Automatic Type) | ATAS-120A |
| • Antenna Base Kit (for ATAS-120A) | ATBK-100 |
| • Active Tuning Antenna (Manual Type) | ATAS-25 |
| • Remote Control Keypad | FH-2 |
| • LAN Unit | SCU-LAN10 |
| • Mounting Bracket | SMB-209 |
| • Carrying Handle | MHG-1 |
| • Packet Cable | CT-39A |
| • VL-1000 Linear Amplifier Connection Cable | CT-58 |

Installation and Interconnections

Antenna Considerations

The FT-710 is designed to connect to a 50 Ohm resistive impedance antenna at the Amateur operating frequencies. Select an appropriate antenna (dipole antenna, YAGI antenna, cubical quad antenna, etc.) that is suitable for the chosen operation and bands.

Construct the antenna and coaxial cable, or use a suitable antenna tuner, to maintain the impedance presented to the FT-710 antenna connector for an SWR of 1.5 or less. Careful preparation of the antenna and/or tuner will permit maximum performance, and protect the transceiver from damage.

High transmitter RF voltages may be present on the antenna; install it so it will not be easily touched when in operation.

Antenna Connections

Carefully follow the illustration regarding the proper connection of antennas and coaxial cables.

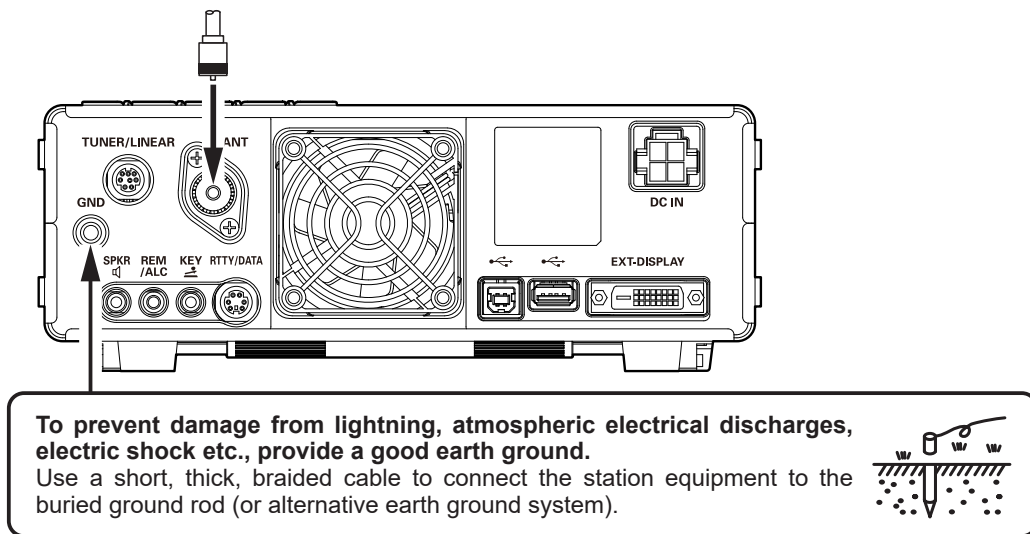

Power Cable Connections

Carefully follow the illustrations regarding the proper connection of the DC power cable.

Use the DC power cable supplied with the FT-710 to make the power connections to the power supply.

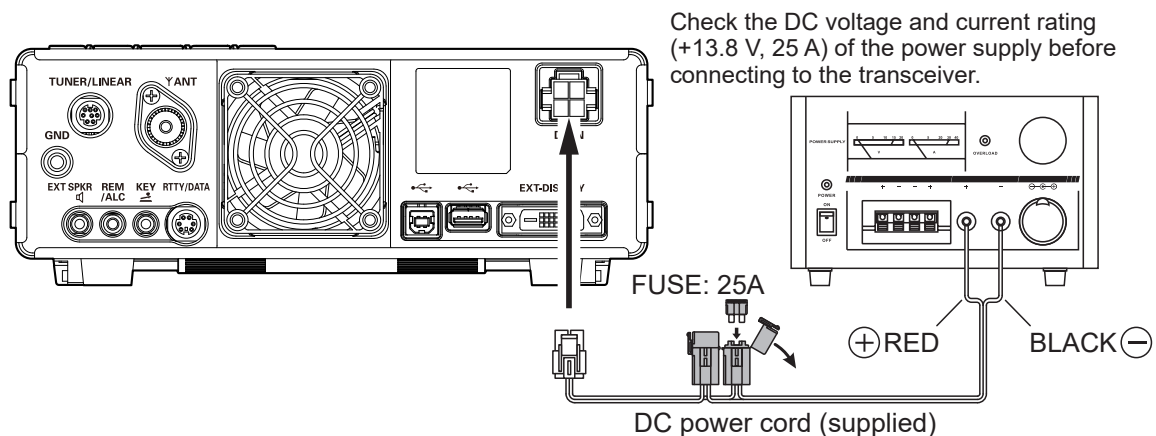

Installation guidelines

- Ensure adequate ventilation around the transceiver, to prevent heat build-up and possible reduction of performance due over heating.
- Do not install the transceiver in a mechanically unstable location, or where objects may fall onto it from above.
- To minimize the possibility of interference to home entertainment devices, take all precautionary steps including separation of TV/FM antennas from Amateur transmitting antennas to the greatest extent possible. Keep the transmitting coaxial cables separated from cables connected to home entertainment devices.
- The AC Power Cord connected to a socket-outlet with earthing connection. A socket-outlet with earthing connection shall connect to protective earthing conductor.

Microphone, Headphone, Key, Keyer and FH-2 Connections

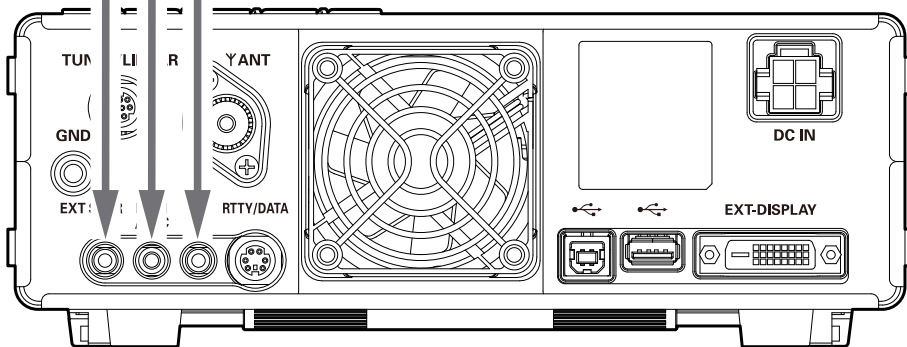
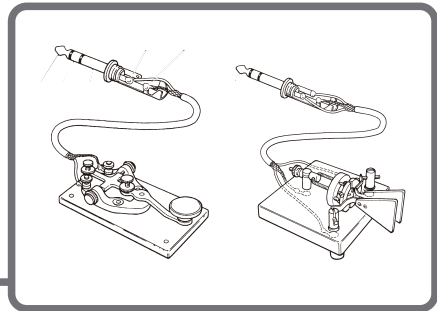
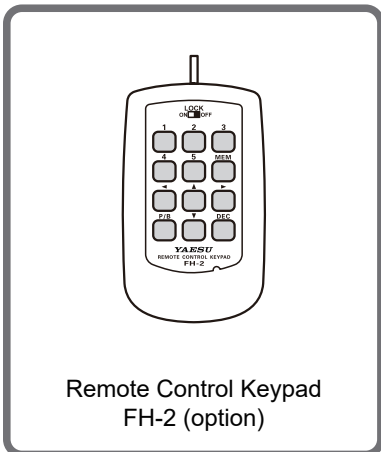
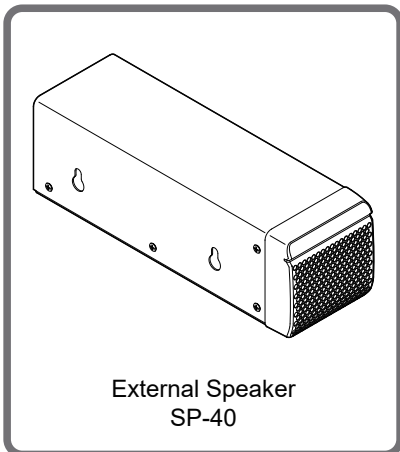
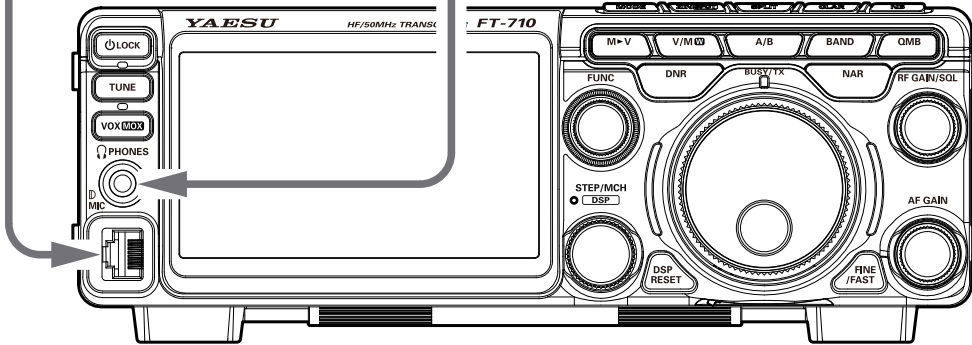
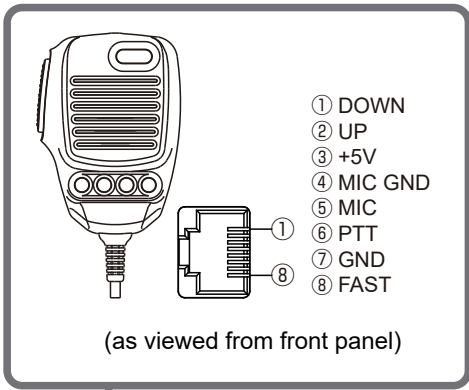

i Key-up voltage is approximately +5.0V DC, and key-down current is approximately 3mA.

Linear Amplifier Interconnections



Be sure that both the FT-710 and VL-1000 are turned OFF, and then follow the installation recommendations contained in the below illustration.

• VL-1000 Linear Amplifier Interconnections



- Refer to the VL-1000 Operating Manual for details regarding amplifier operation.
- Do not attempt to connect or disconnect coaxial cables when your hands are wet.
- Set the Setting Menu item "TUN/LIN PORT SELECT" to "LINEAR" (page 89).
- Since the ALC cable is connected to the REM/ALC jack, the optional FH-2 cannot be connected.

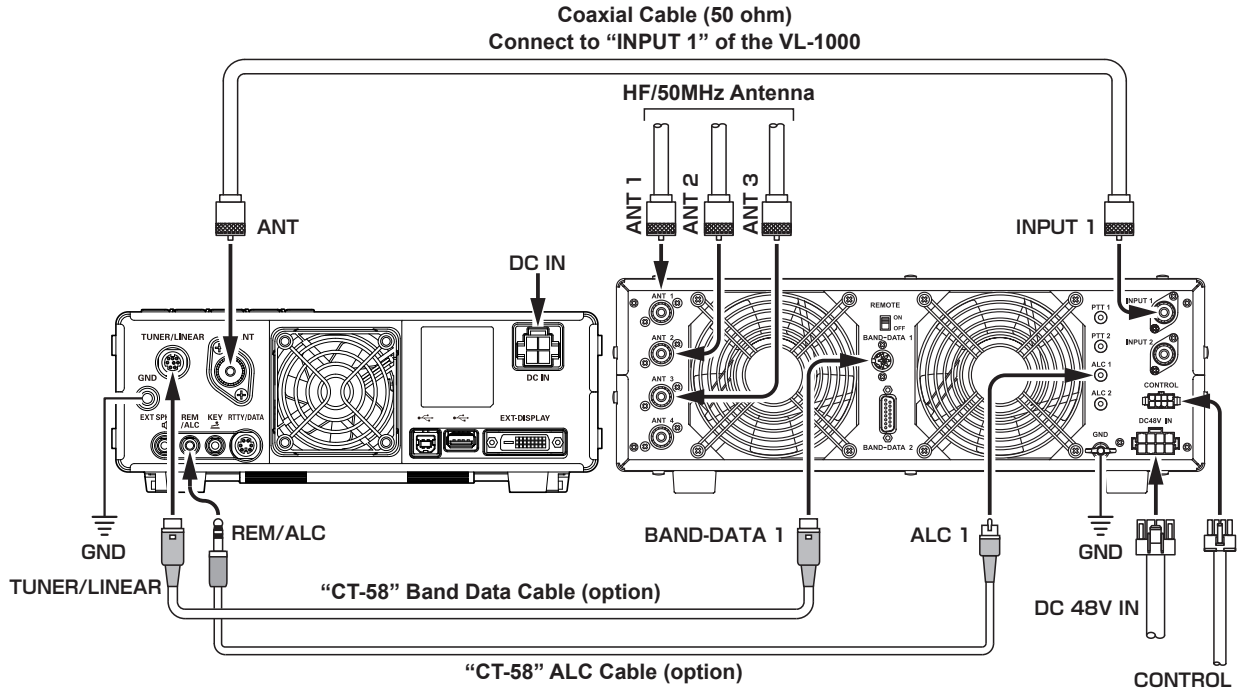

Display connections

The video digital output of the FT-710 transceiver can be shown on a large monitor. Use a commercially available DVI-D cable to connect a display monitor directly to the “EXT-DISPLAY” terminal (DVI-D) on the back of the FT-710.



The DVI-D cable can be used with either single link or dual link.

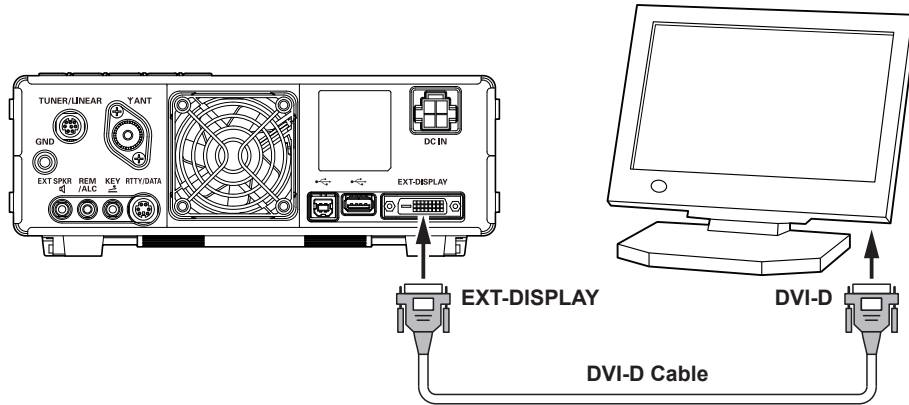

Remote operation (LAN unit “SCU-LAN10”) connection

Operate the transceiver from a remote location. Use the optional LAN unit “SCU-LAN10” to connect the FT-710 to a LAN or the Internet, then use the PC control software that can be downloaded from the Yaesu website. In addition to the basic remote operation of the transceiver, the LAN unit supports monitoring the various scope displays, so you can operate comfortably. In addition to remote operation from a remote location, you can connect to your home LAN and monitor the band status on a large display from a convenient location away from the ham shack.

In addition to transmitted and received audio, the RF scope and AF scope can be remoted, so comfortable remote communication can be performed while easily setting and tuning the band status display, making various filter settings, interference removal function, etc. are possible using the scope function from a personal computer.

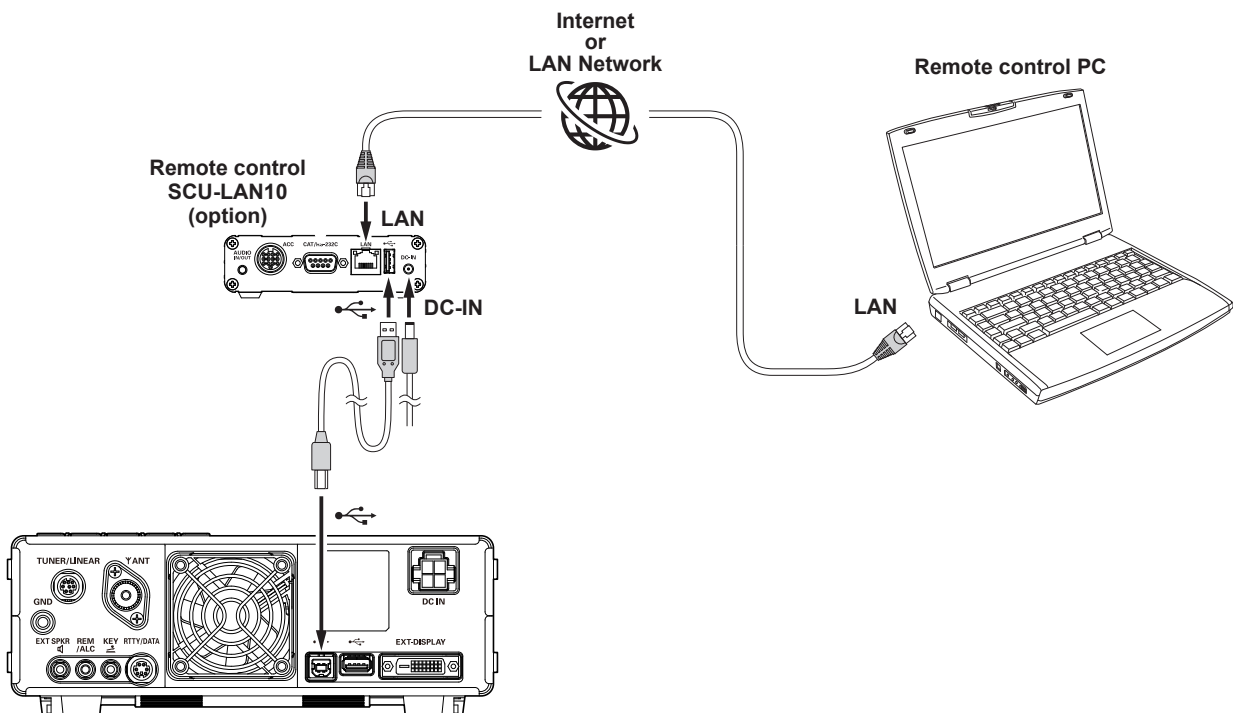

AESS (Acoustic Enhanced Speaker System)

The combination of the internal speaker on top of the transceiver with the external speaker "SP-40", reproduces high-quality received audio with a wide frequency range and a three-dimensional acoustic effect. Set the optimum sound quality by adjusting the output balance and frequency characteristics of the two speakers according to your preference.



- The AESS is designed to function optimally with the included speaker "SP-40". It will not perform properly with other speakers.
- When moving or transporting the FT-710, remove the SP-40 to prevent it from falling off.

SP-40 connections

The SP-40 can be mounted on either the left or right side of the transceiver.

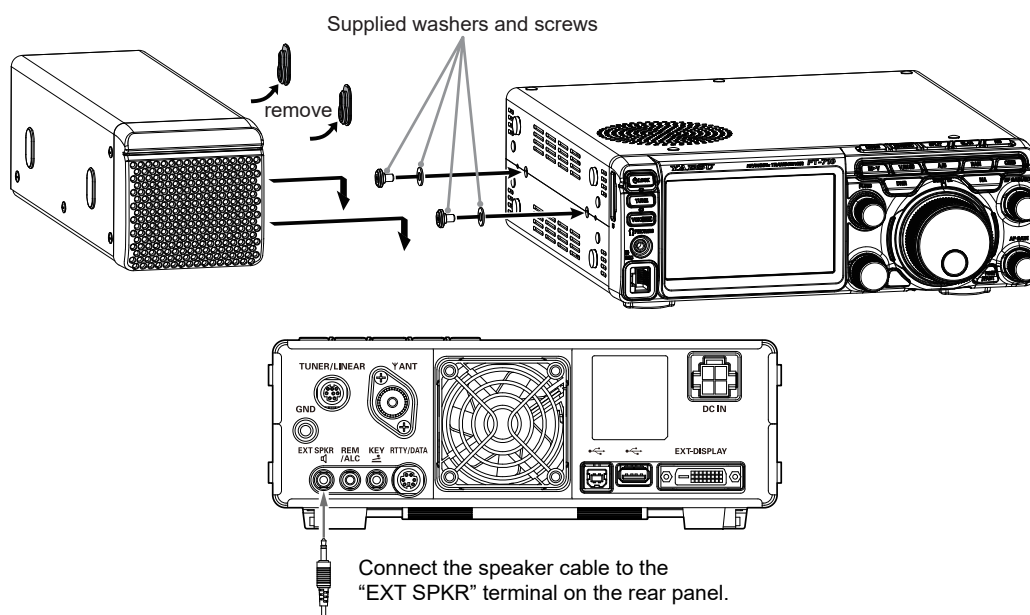

• Change the output balance of the two speakers

1. Press the [FUNC] knob.

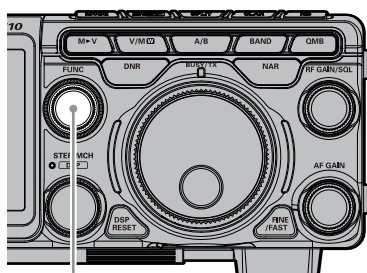

FUNC knob

2. Touch [AESS].



3. Rotate the [FUNC] knob to adjust the output balance of the two speakers, according to your liking. It is recommended to use it at around 50%.

• Change the frequency characteristics

1. Press the [FUNC] knob.

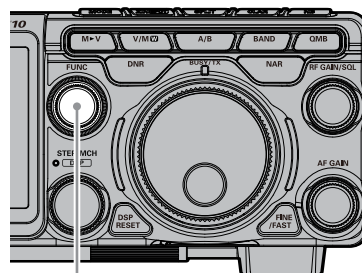

FUNC knob

2. Touch [AESS-CF].



3. Rotate the [FUNC] knob to select the cutoff frequency from "700Hz" and "1000Hz". Normally, 700Hz is a balanced sound quality, but when listening at a loud volume, set it to 1000Hz.

Rear Panel

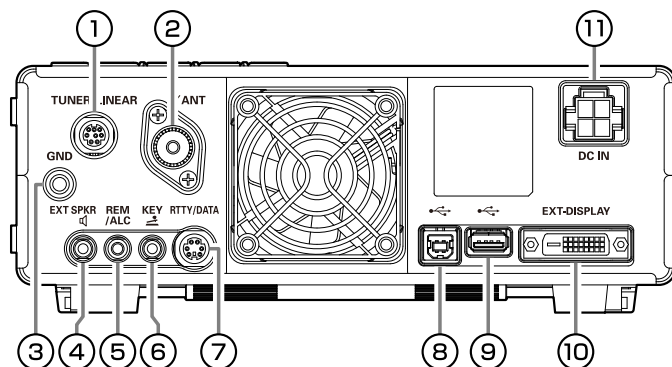

1 TUNER/LINEAR

This 8-pin output jack is used to connect to the FC-40 External Automatic Antenna Tuner or a Linear Amplifier.

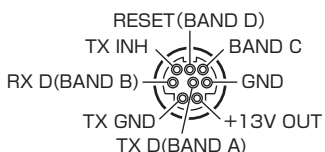

Refer to the table below for the BAND DATA terminal levels when using a linear amplifier.

BAND	BAND DATA				BAND	BAND DATA			
	A	B	C	D		A	B	C	D
400k	H	L	H	H	18	L	H	H	L
1	L	H	H	H	21	H	H	H	L
1.8	H	L	L	L	24.5	L	L	L	H
3.5	L	H	L	L	28	H	L	L	H
5 / 7	H	H	L	L	50	L	H	L	H
10	L	L	H	H	70	H	H	H	H
14	H	L	H	L					

2 ANT

Connect the main antenna here, using type-M (PL-259) connectors and coaxial feed lines. The internal antenna tuner affects only the antenna connected here, and only during transmission.

3 GND

Use this terminal to connect the transceiver to a good earth ground, for safety and optimal performance.

4 EXT SPKR

This 3.5-mm, 2-contact, jack provides audio output for an external loudspeaker "SP-40". The impedance at the jack is 4-8 Ohms.

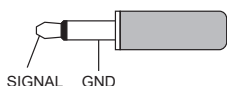

5 REM/ALC

By plugging the FH-2 Remote Control Keypad into this jack, direct access to the FT-710 CPU is provided for control functions of the contest memory keying, and also frequency and function control. When a device such as a linear amplifier is connected, this is an external ALC current input jack.

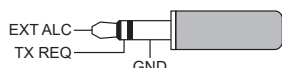

Set menu item "TUN/LIN PORT SELECT" to "LINEAR".

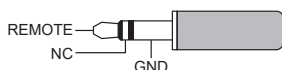

Set menu item "TUN/LIN PORT SELECT" to other than "LINEAR".

6 KEY

This 3.5-mm, 3-contact jack accepts a CW key or keyer paddle. A two-contact plug cannot be used in this jack. Key-up voltage is +5.0V DC, and key-down current is 3mA.



When connecting a single straight key



When connecting an electronic keyer paddle

7 RTTY/DATA

This 6-pin input/output jack accepts AFSK input from a Terminal Node Controller (TNC); it also provides fixed level receiver audio output, and FSK keying line.



8 USB

Connecting to a computer from this jack with a commercially available USB cable allows remote control by CAT commands from a computer. The jack can also be used for input and output of audio signals and transmitter control. A USB driver is required for remote control from a computer. Download the driver from the Yaesu website (<http://www.yaesu.com>).

9 USB Jack

Connect a USB A type keyboard or mouse. They can be used to select items on the screen or to enter characters.

10 EXT-DISPLAY

DVI-D connector for connecting an external monitor. When using an external monitor, set the setting menu item "EXT DISPLAY" to "ON".



Connect a monitor that supports 800 x 480 resolution or 800 x 600 resolution.

11 DC IN

This is the DC power supply connection for the transceiver.

Use the supplied DC cable to connect directly to a DC power supply, which must be capable of supplying at least 25 A @13.8 VDC.



SSM-75E Microphone Switches

① PTT Switch

Switches Transmit/Receive.
Press to transmit and release to receive.

② DWN / UP Key

The [UP]/[DWN] keys may also be used to manually scan the frequency upward or downward.

- The amount of frequency change depends on the operation mode (default setting: see table below).

Operating Mode	UP	DWN
LSB / USB / CW-L / CW-U	+20Hz	-20Hz
DATA-L / DATA-U RTTY-L / RTTY-U / PSK	+10Hz	-10Hz
AM / AM-N / FM / FM-N DATA-FM / D-FM-N	+5kHz	-5kHz

- The frequency change can be changed in the setting menu.

Operating Mode	Menu Item	Step
LSB / USB CW-L / CW-U	SSB/CW DIAL STEP	5/10/20 (Hz)
DATA-L / DATA-U RTTY-L / RTTY-U PSK	RTTY/PSK DIAL STEP	
AM / AM-N	AM CH STEP	2.5/5/9/10/ 12.5/25 (kHz)
FM / FM-N DATA-FM D-FM-N	FM CH STEP	5/6.25/10/ 12.5/20/25 (kHz)

③ MUTE Key

While pressing the MUTE key, the receiver audio from the speaker will be muted.

④ Microphone

Speak into the microphone in a normal tone of voice with the microphone 5cm away from the mouth.

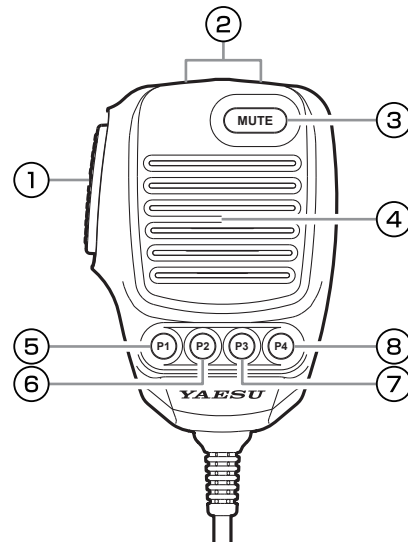

⑤ P1 key

This key toggles the ON/OFF lock for the MAIN Dial knob. When "Lock" is ON, the MAIN Dial knob can still be turned, but the frequency will not change, and "LOCK" appears in the display. It is the same function as the [LOCK] key on the front panel of the transceiver.

⑥ P2 key

The current operation status can be stored in a dedicated memory channel (QMB: Quick Memory Bank) with one touch. It is the same function as the [QMB] key on the front panel of the transceiver.

⑦ P3 key

Pressing this key momentarily, exchanges the VFO-A and VFO-B frequency data. It is the same function as the [A/B] key on the front panel of the transceiver.

⑧ P4 key

This key toggles frequency control between VFO and the memory system. It is the same function as the [V/M] key on the front panel of the transceiver.

The functions of the [P1] / [P2] / [P3] / [P4] / [UP] / [DWN] keys can be assigned by the following operations:

- Press the [FUNC] knob.
- Select [OPERATION SETTING] → [GENERAL].
- Select a key to assign a function [MIC P1]/[MIC P2]/[MIC P3]/[MIC P4]/[MIC UP]/[MIC DOWN].
- Rotate the [FUNC] knob, or touch "<" or ">" on either side of the value to select a function (see the table below).
- Touch [BACK] several times to return to normal operation.

LOCK	: Toggles the ON/OFF lock for the MAIN Dial knob.
QMB	: QMB (Quick Memory Bank) function.
A/B	: Swaps the VFO-A and VFO-B frequency data.
V/M	: Toggles frequency control between VFO and the memory system.
TUNER	: Turns the built-in antenna tuner ON/OFF.
VOX/MOX	: Press to turn the VOX function ON/OFF.
	: Press and hold to activate the MOX function.
	: Change the operation mode.
MODE	: Press to activate the auto-zero function.
ZIN SPOT	: Press and hold to activate the sidetone.
SPLIT	: SPLIT function.

FINE	: Sets the fine tuning ON/OFF.
NAR	: Sets the Narrow ON/OFF.
NB	: Activates the NB (Noise blanker) function.
DNR	: Activates the DNR (Digital Noise Reduction) function.
FREQ UP	: Change to a higher frequency.
FREQ DOWN	: Change to a Lower frequency.
BAND UP	: Change to a higher Operation Band.
BAND DOWN	: Change to a Lower Operation Band.
ATT	: Turns the ATT (Attenuator) ON/OFF.
IPO	: Activates the IPO.
DNF	: Turns the DNF (Digital Notch Filter) ON/OFF.
AGC	: Adjust the AGC receiver-recovery time.

Display Indications

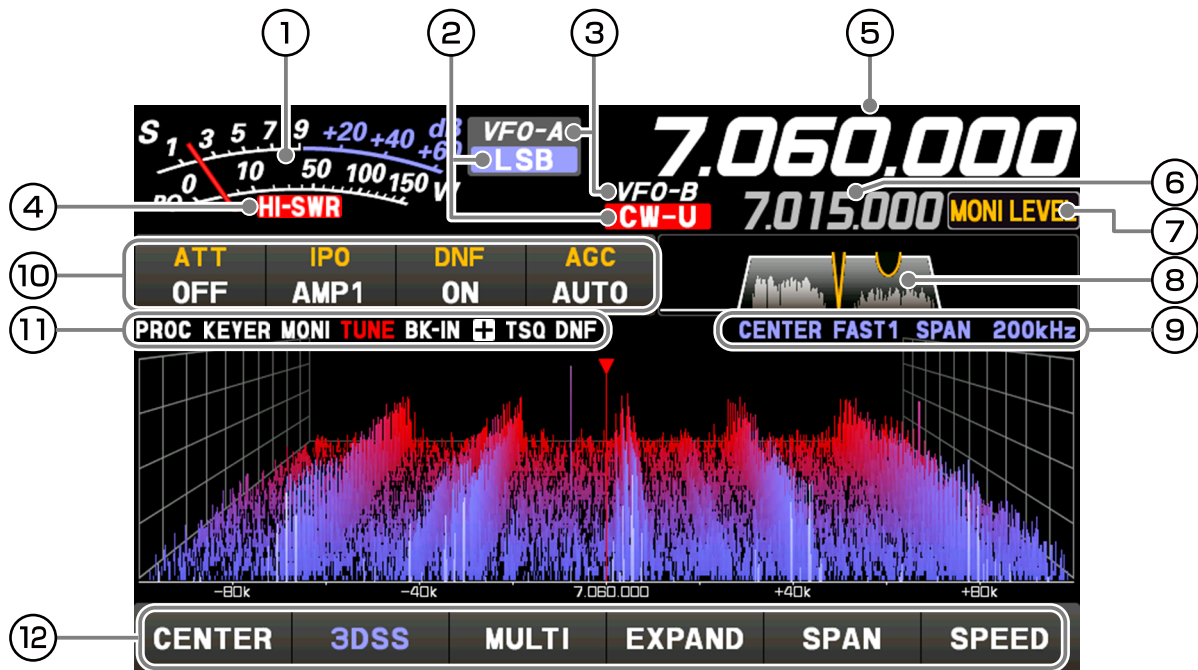

- ① It operates as an S meter in receive. In transmit, select the desired meter from: PO, COMP, ALC, VDD, ID, and SWR.
- ② Displays the current operation mode.
- ③ In VFO mode, “VFO-A” or “VFO-B” is displayed. In memory mode, the type and channel number of the recalled memory are displayed.
- ④ This display warns of an abnormality in the antenna system. If it lights up, check the antenna system immediately.
- ⑤ Displays the transmit/receive frequency of Main-band.
- ⑥ Displays the transmit/receive frequency of Sub-band. While the clarifier function is operating, the offset (difference between the receive frequency and the transmit frequency) is displayed.
- ⑦ The functions that operate when the [FUNC] knob is turned are displayed.
- ⑧ Displays the passband status of the Digital filter.
- ⑨ Displays the mode, the sweep speed, and span width (display range) of the scope screen.
- ⑩ Displays the setting status of assorted important receiver operations. The setting can be changed by touching it.
- ⑪ The icon of the operating function lights up.
- ⑫ Touch the scope screen keys to switch the display mode of the screen between the 3DSS display and waterfall display, to display the oscilloscope and AF-FFT, to switch the display area of the scope screen, to set the frequency span (display range), or to switch the sweep speed.

① Meter Display

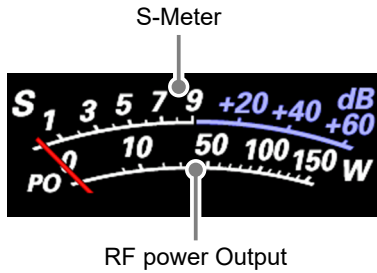

When the meter display screen is touched, the transmit meter selection screen is shown (the default setting is “PO”).

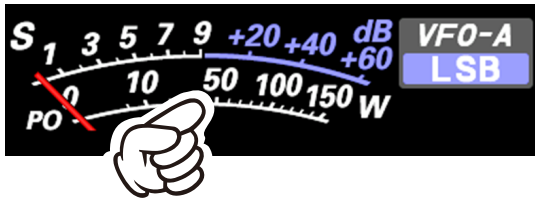

Touch the meter area



AMC gain control display
(Displays compression level during speech processor operation)
Make adjustments by pressing the [FUNC] knob →
→ touch [COMP] → rotate the [FUNC] knob.

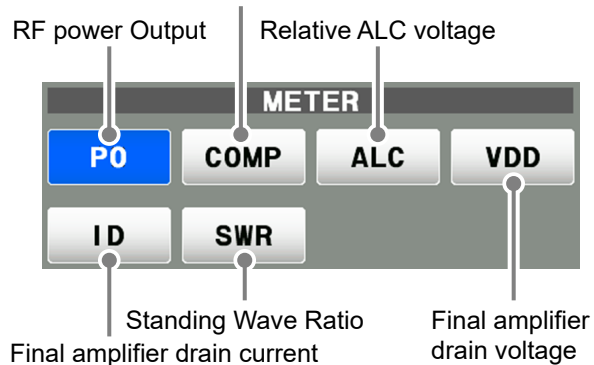

② Operation MODE Display

Displays the current operating mode. When touched the operation mode selection screen is displayed. Touch the desired operation mode to select it.

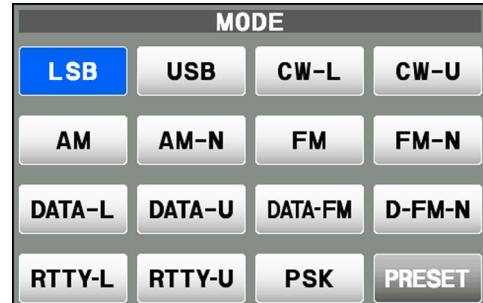

i Touch [PRESET] to display the settings that apply to the FT8 operation.

③ Operation status Display

VFO-A: Lights in VFO-A mode.
VFO-B: Lights in VFO-B mode.
M-xx: Displays the selected channel number in memory mode.
MT: Lights up during memory tuning operation.
QMBxx: Lights up during operation with quick memory.
M-Pxx: Lights up during programmable memory scan operation.
EMG: Emergency call set frequency call lights up.

④ HI-SWR Display



This is a warning notification of an abnormality in the antenna system.

If “HI-SWR” lights up, immediately check if for any abnormality in the antenna system.

⑤ Frequency Display (VFO-A)

Displays the transmit and receive frequencies of VFO-A. Press the [A/B] key to switch between VFO-A and VFO-B, the frequency of VFO-B is displayed.

• Keyboard Frequency Entry

1. Touch the “Hz” area of the frequency display.

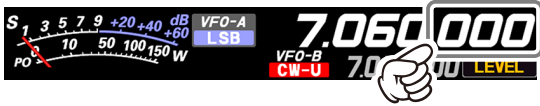

2. Enter the frequency using the numeric keys.

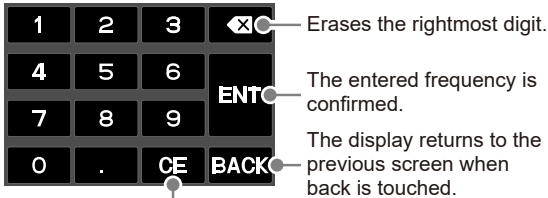

Clear all entered numbers.

- If there is no operation within 10 seconds, the input will be canceled.
3. Touch [ENT] to confirm.
 - A short-cut for frequencies ending in zero - touch [ENT] after the last non-zero digit.

Example:

To enter 7.00.000MHz

[0] → [7] → [ENT] or [7] → [.] → [ENT]

To enter 7.03.000MHz

[7] → [.] → [0] → [3] → [ENT]

• Tuning in 1 MHz or 1 kHz Steps

To temporarily set the dial knob to 1MHz or 1kHz steps, touch the “MHz” or “kHz” area of the frequency display.



Touch “MHz” or “kHz” area of the frequency display to confirm. If there is no operation within 3 seconds, the frequency will be fixed.

i Touch the Scope Screen, to easily move to the touched frequency.

⑥ Frequency Display (VFO-B)

Displays the transmit and receive frequencies of VFO-B. Press the [A/B] key to switch between VFO-B and VFO-A, the frequency of VFO-A is displayed.

When the clarifier function is active, the offset frequency is displayed.

• When the clarifier function is active

The clarifier is used to adjust the transceiver receive frequency to match the other station transmit frequency and improve the audio; or to shift the transmit frequency of this station when the transmit frequency of the contact station is shifted.

When the receive frequency is offset by +20 Hz.

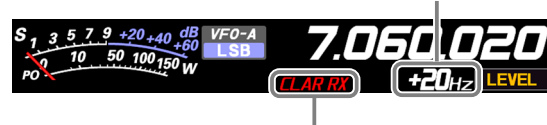

- CLAR RX : Changes only the receive frequency while leaving the transmit frequency as it is.
- CLAR TX : Changes only the transmit frequency while leaving the receive frequency as it is.
- CLAR RXTX :
 - After changing the receive frequency with the clarifier, pressing the [CLAR] key twice will set the transmit frequency to match the receive frequency.
 - After changing the transmit frequency with the clarifier, pressing the [CLAR] key will set the receive frequency to match the transmit frequency.

Press the [CLAR] key, the display will show “CLAR RX” in red and the clarifier will be active.

Rotate the DIAL knob to change the offset frequency of the clarifier.

To cancel Clarifier operation, press the [CLAR] key several times.

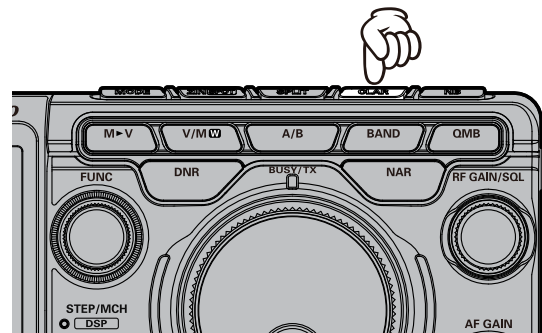

⑦ Operation of the display [FUNC] knob

Displays the multiple functions that may be operated when the [FUNC] knob is pressed.

Normally, it is recommended to adjust the level of the spectrum scope with the [LEVEL] knob.

The last used function is recalled when the [FUNC] knob is pressed. Therefore you can easily call up and then set a function by turning the [FUNC] knob.

To change the function of the [FUNC] knob, touch the desired item that appears on the function screen when the [FUNC] knob is pressed, or turn the [FUNC] knob to select an item and then press the [FUNC] knob.

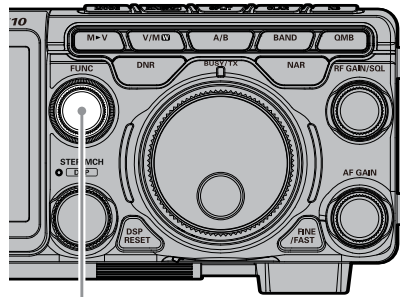

FUNC knob

Operation of the FUNC knob



The following settings and operations can be performed with the [FUNC] control.

- LEVEL** : Adjust the reference level to make it easier to distinguish the scope display target signal from the noise.
- PEAK** : Adjust the Peak Signal Color Density.
- MARKER** : ON/OFF Marker indicates the transmit and receive frequency position within the Scope Display image.
- COLOR** : Changes the scope display color.
- CONTRAST** : Adjust the contrast of the TFT display.
- DIMMER** : Adjust the brightness of the TFT display.
- M-GROUP** : Memory group selection.
- MIC GAIN** : Adjusts the microphone gain.
- MIC EQ** : Three-Band Parametric Microphone Equalizer is turned ON/OFF.
- PROC LEVEL** : Adjusts the Speech Processor Gain.
- AMC LEVEL** : Adjusts the AMC (Automatic Microphone Gain Control) Gain.
- VOX GAIN** : VOX gain setting.
- VOX DELAY** : VOX delay setting.
- ANTI VOX** : Anti-VOX Settings.
- RF POWER** : Transmit power setting.
- MONI LEVEL** : Monitor level adjustment.
- KEYER** : Built-in electronic keyer is turned ON/OFF.
- BK-IN** : CW Break-in function is turned ON/OFF.
- CW SPEED** : Adjusts the desired sending speed.
- CW PITCH** : Adjusts the CW tone when receiving the CW signal and the side tone monitor.
- BK-DELAY** : Adjust the hang time after the CW transmitting ends.
- AESS** : Change the output balance of the two speakers.
- AESS-CF** : Change the frequency characteristics.

⑧ Filter Function Display

Displays the passband status of the Digital filter. The operation of WIDTH, SHIFT, NOTCH, CONTOUR etc. can be observed.

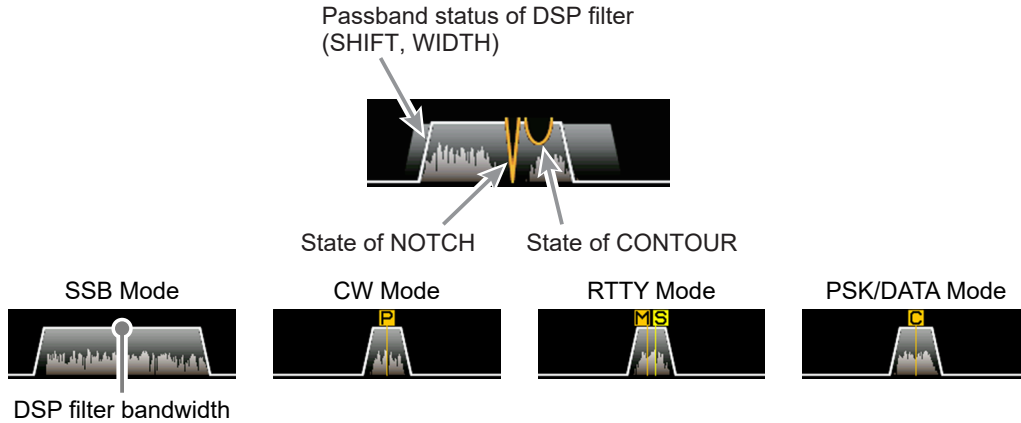

Touch the filter display to reveal and check the setting value of the last used function from SHIFT, WIDTH, NOTCH, CONTOUR, and APF. The setting may be changed by turning the [FUNC] knob of the active function.

Example: When the last function used is the NOTCH function
Touch the filter display to display the NOTCH function setting value.

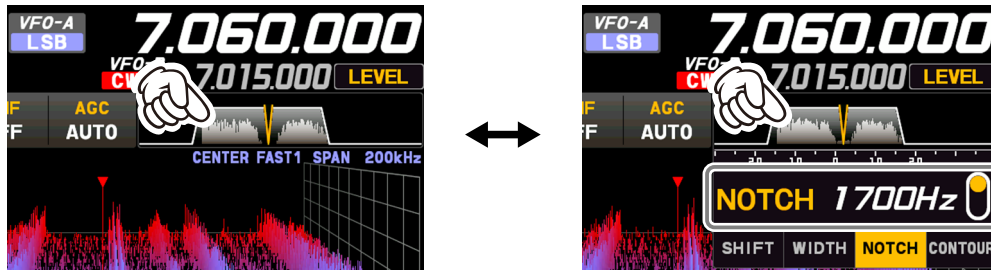

• Turn the spectrum display OFF

To display only the Digital filter bandwidth information, press and hold the spectrum area of the filter function display to clear the spectrum view. To display it, press and hold again.

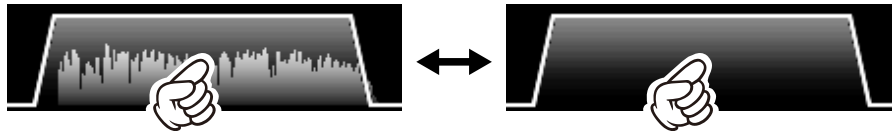

⑨ Information displayed on the scope screen

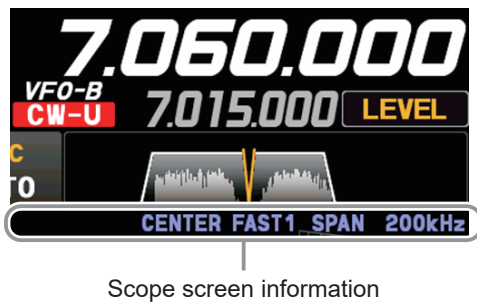

CENTER : The receive frequency is always shown at the center of the screen and spectrum display.

The band spectrum is shown within the range set by "SPAN". The CENTER mode is convenient for monitoring the signal activity around the operating frequency.

CURSOR : Monitors the spectrum within the range set with "SPAN". When the frequency (marker) exceeds the upper limit or the lower limit of the range, the screen is automatically scrolled and the status beyond the setting range can be observed.

FIX : Enter the start frequency of the scope.

SLOW1 : sweep speed Slow

SLOW2 : sweep speed ↑

FAST1 : sweep speed Normal

FAST2 : sweep speed ↓

FAST3 : sweep speed Fast

STOP : Temporarily hold the operation of DSS display and waterfall display.

SPAN *nn*kHz : Scope Screen frequency span (display range).

⑩ Important Receiver Settings

The status of various operations that are important during receive, are shown at the bottom of the display. To change a setting, touch the appropriate location on the display.

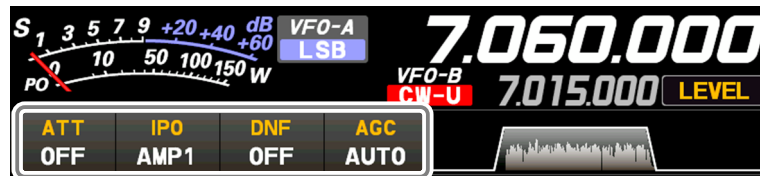

Important setting items when receiving

• ATT (Attenuator)

Displays the current ATT (Amount of receive input signal attenuation).

When the desired signal is extremely strong or the noise level is high on a low frequency band, activate the attenuator to reduce the incoming signal or noise from the antenna.

After touching [ATT], touch the desired attenuation amount.

The attenuator is set independently for each operation band.

OFF	Attenuator is Off
6dB	The incoming signal power is reduced by 6dB (Signal voltage reduced to 1/2)
12dB	The incoming signal power is reduced by 12dB (Signal voltage reduced to 1/4)
18dB	The incoming signal power is reduced by 18dB (Signal voltage reduced to 1/8)

• IPO

The IPO (Intercept Point Optimization) function can establish the gain of the RF amplifier section to accommodate the connected antenna and the received signal conditions. IPO can be selected from three operating conditions.

AMP1: One stage RF amplifier is connected. This is a well-balanced operation of receiver sensitivity and characteristics (Approximately 10 dB gain).

AMP2: Two RF amplifiers are connected in series to give top priority to sensitivity (Approximately 20 dB gain).

IPO: The received signal is input to the IF mixer without passing through the RF amplifier. This can greatly improve receiving, especially in the harsh low band signal environment.

After touching [IPO], touch the desired operating condition.

- IPO is set independently for each operation band.
- Normally, select "AMP1".
- The IPO can not only attenuate the input signal but also improve the intermodulation characteristics. It is most effective to operate the IPO first, and then use the ATT if the signal is still too strong. The noise level can be attenuated and S/N greatly improved.



• DNF (Digital NOTCH Filter)

The Digital NOTCH Filter (DNF) is an effective beat-canceling filter that can null out a number of interfering beat notes inside the receiver pass-band.

Because this is an Auto-Notch feature, there is no adjustment knob associated with this filter.

• AGC (Automatic Gain Control)

Displays the currently selected AGC setting.

The AGC system is designed to help compensate for fading and other propagation effects. The AGC characteristics can be individually set for each operating mode. The basic objective of AGC is to maintain a constant audio output level once a certain minimum threshold of signal strength is achieved.

After touching [AGC], touch the desired time constant.

- AGC can be set for each operation band.
- The "AUTO" selection mode selects the optimum receiver-recovery time for the reception mode.

Operating Mode	AUTO AGC Selection
LSB / USB / AM / AM-N	SLOW
CW-L / CW-U / FM / FM-N DATA-FM / D-FM-N	FAST
RTTY-L / RTTY-U DATA-L / DATA-U / PSK	MID



Normally, AGC is set to "AUTO", which automatically selects the time constant according to the received signal type, but when receiving a weak signal or when there is noise and fading, the AGC action may be changed according to the reception condition at that time. Change the time constant to make received signals most audible



Several aspects of AGC performance may be configured via the Menu. However, because AGC can have such a profound impact on overall receiver performance, we generally do not recommend any changes to the AGC Menu selections until you are thoroughly familiar with the performance of the FT-710.

⑪ Information displayed on the scope screen

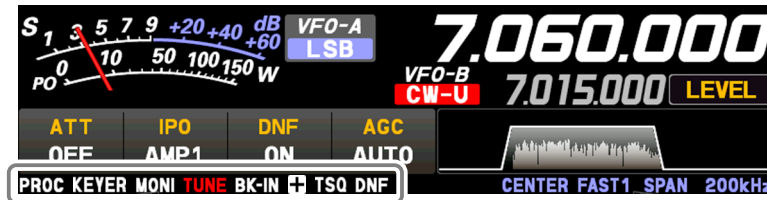

- PROC** : Lights when the Speech function is activated.
- KEYER** : Lights when the Built-in electronic keyer is activated.
- MONI** : Lights when the MONITOR function is activated.
- TUNE** : Lights when the internal Automatic Antenna Tuner is activated. Blinks during tuning.
- BK-IN** : Lights when the CW Break-in function is activated.
- +/-** : Lights in plus (+) or negative (-) shift (repeater operation).
- ENC** : Lights when the tone encoder is operating.
- TSQ** : Lights during tone squelch operation.
- DNF** : Lights when the DNF (Digital Notch Filter) is activated.

⑫ Scope Display Setting

In addition to the conventional two-dimensional waterfall spectrum display, Yaesu has added the 3-Dimension Spectrum Stream (3DSS) color display. The constantly changing band conditions and signals are depicted in real time and color. The frequency span is shown on the horizontal X axis, the vertical Y axis depicts the signals and their strengths, and the time is represented on the receding Z axis. The FT-710 operator can intuitively grasp the band and signal conditions at any instant.

• CENTER/CURSOR/FIX

Switches the Spectrum Scope operation each time the key is touched.

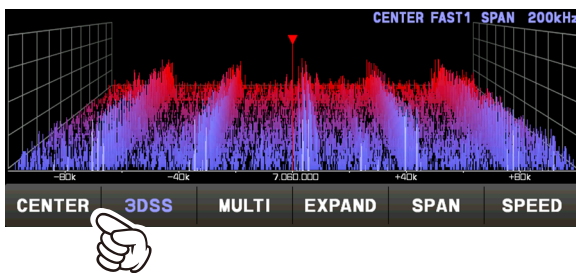

- When the display area is touched, the receive frequency is moved to that point.
- In CENTER mode, the frequency touched becomes the center.
- In CURSOR and FIX mode, the marker and the receive frequency move to the touched position.

• CENTER

The receive frequency is always shown at the center of the screen and spectrum display. The band spectrum is shown within the range set by "SPAN". The CENTER mode is convenient for monitoring the signal activity around the operating frequency.

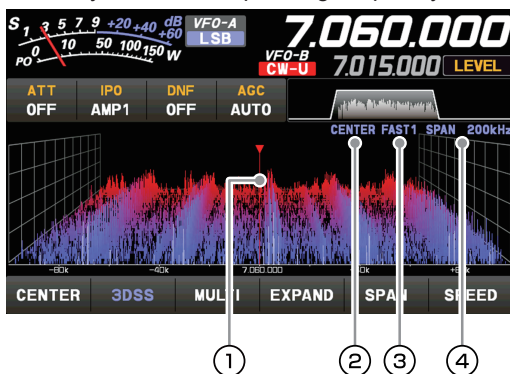

- ① Marker*
- ② Current display mode (CENTER)
- ③ Sweep Speed
- ④ Scope Screen frequency span (display range).

*At factory shipment, marker display is ON.

• CURSOR

Monitors the spectrum within the range set with "SPAN". When the frequency (marker) exceeds the upper limit or the lower limit of the range, the screen is automatically scrolled and the status beyond the setting range can be observed.

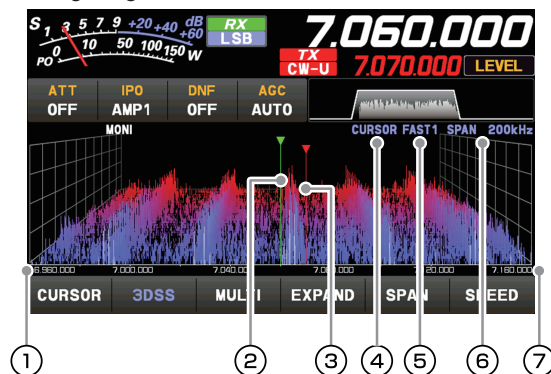

- ① The lower limit frequency of the display area.
- ② Marker* (Receive Frequency)
- ③ Marker* (Transmit Frequency)
- ④ Current display mode (CURSOR)
- ⑤ Sweep Speed
- ⑥ Scope Screen frequency span (display range).
- ⑦ The upper limit frequency of the display area.

*At factory shipment, marker display is ON.

• FIX

To use Fixed Mode, enter the start frequency of the scope.

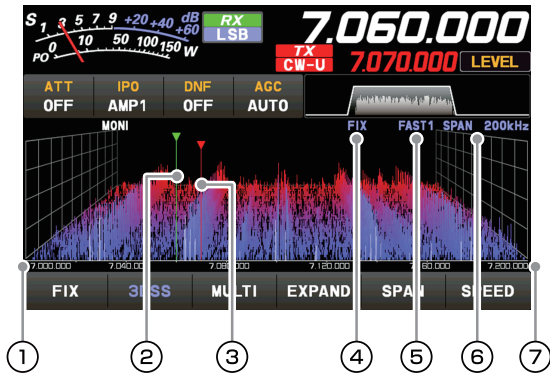

- ① Display area start frequency
- ② Marker* (Reception Frequency)
- ③ Marker* (Transmit Frequency)
- ④ Current display mode (FIX)
- ⑤ Sweep Speed
- ⑥ Scope Screen frequency span (display range).
- ⑦ The upper limit frequency of the display area.

*At factory shipment, marker display is ON.

FIX is displayed at the top of the scope screen. Press and hold [FIX] while FIX is displayed, the frequency input screen will be displayed, and the start frequency can be entered:

Example:

To enter 7.000.000 MHz

[0] → [7] → [ENT] or [7] → [.] → [ENT]

To enter 7.030.000 MHz

[7] → [.] → [0] → [3] → [ENT]

• 3DSS

Switch between the 3DSS display and the waterfall display.

The display will change each time it is touched:

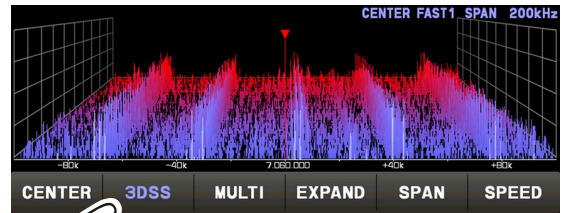

3DSS type

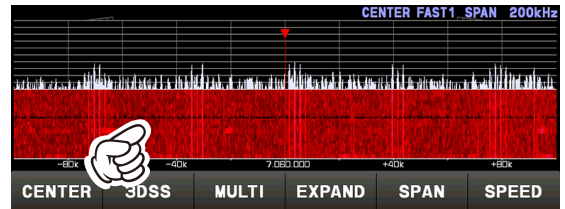

Waterfall type

• MULTI

In addition to the scope display, the oscilloscope and AF-FFT are also presented.

Touch again to return to the original screen.

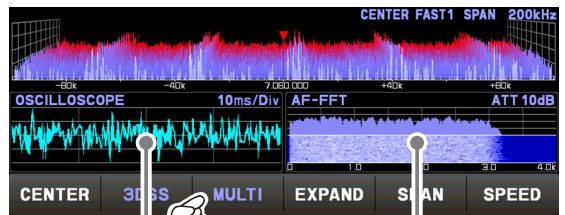

Touch this area to set the attenuator.

Touch this area to set the level and sweep speed.

EXPAND

The display area of the scope screen may be expanded vertically. Touch to expand the display. Touch again to return to the original.

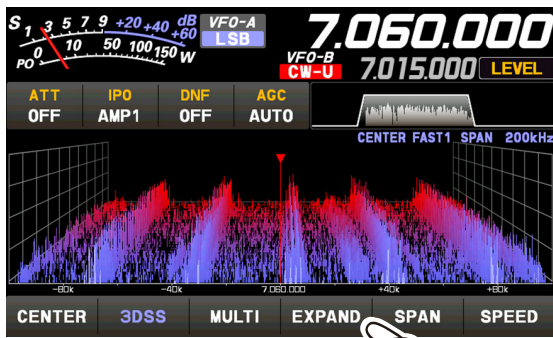

Normal Display

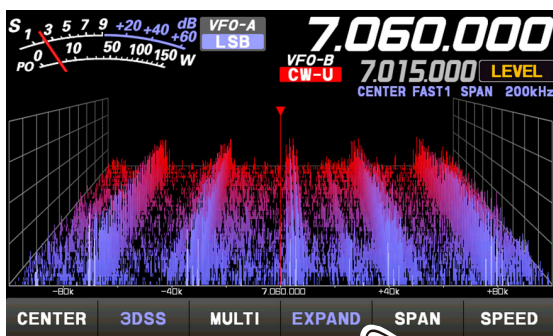

Larger View

SPAN

Set the frequency span (display range) of the scope screen. After touching, select the desired span.

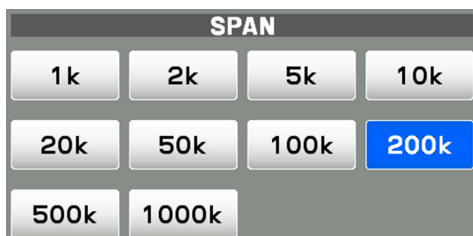
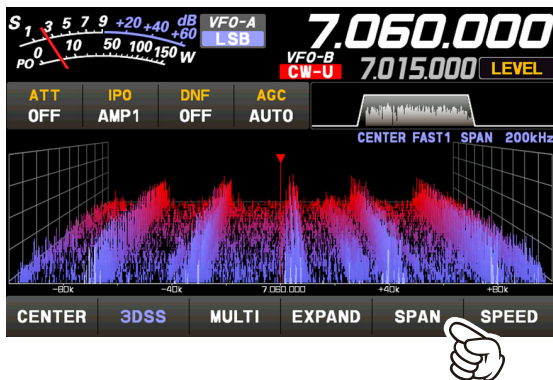

The display level changes when SPAN is changed, so reset the optimum display level with [LEVEL] each time.

SPEED

Sets the Scope Display sweep speed. After touching, select the desired speed.

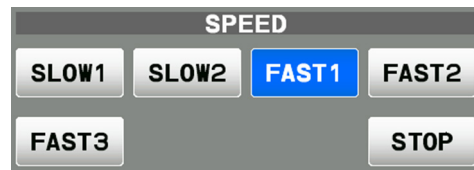
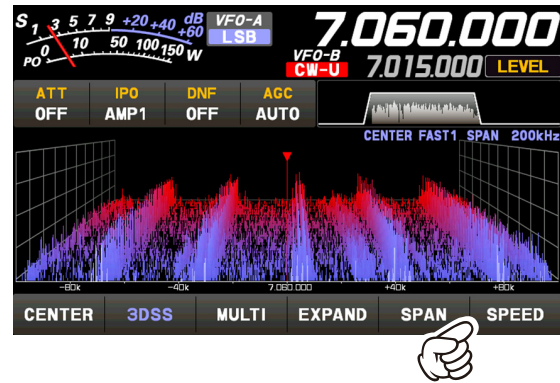

- SLOW1 : sweep speed Slow
- SLOW2 : sweep speed ↑
- FAST1 : sweep speed Normal
- FAST2 : sweep speed ↓
- FAST3 : sweep speed Fast
- STOP : Touch [STOP] to temporarily hold the 3DSS display and waterfall display operations. Touch [STOP] again or another speed, to release the hold.

Set with the FUNC knob

Operate the [FUNC] knob to make the following settings related to the display.

- LEVEL** : Adjust the LEVEL of the scope for the best image on the screen.
- PEAK** : Adjust the color density with respect to the signal level on the scope screen in 5 steps (LV1 to LV5).
- MARKER** : ON/OFF Marker indicates the transmit and receive frequency position within the Scope Display image.
- COLOR** : Changes the scope screen display color from 11 types.
- CONTRAST** : Adjust the TFT display contrast (difference between light and dark) in 21 steps.
- DIMMER** : Adjust the TFT display brightness in 21 steps.

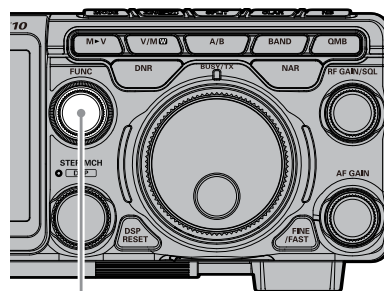

FUNC knob

The last function used is retained in the [FUNC] knob so it can be easily set by operating the [FUNC] knob. Normally, it is suggested to utilize the [FUNC] knob as the [LEVEL] knob for the spectrum scope.

• LEVEL

Adjust the level to make it easier to distinguish between the desired signal and noise. The display level changes depending on antenna gain, condition, frequency band, SPAN and so on. Always adjust the LEVEL for the best image on the screen.

Press the [FUNC] knob then touch [LEVEL], and then turn the [FUNC] knob to select the desired level.



- On the 3DSS screen, weak signals may be more easily observed by adjusting the LEVEL so that the noise level can be seen only a little, so always adjust the LEVEL and use it at the optimum position.
- Be sure to make adjustments when changing bands or changing SPAN.
- If the level is changed, the signal strength also appears to change, but it does not affect the actual signal input level.



• PEAK

The color density may be adjusted to the level of the signal. Touch PEAK and then select the desired color concentration.

Press the [FUNC] knob then touch [PEAK], and then turn the [FUNC] knob to select the desired level.



- LV1 : Thin
- LV2 : ↑
- LV3 : Normal
- LV4 : ↓
- LV5 : Dark

• MARKER

Displays markers that indicates the position of the current receive and the transmit frequencies in the spectrum.

Press the [FUNC] knob then touch [MARKER] to turn the MARKER ON or OFF. Normally leave it ON.

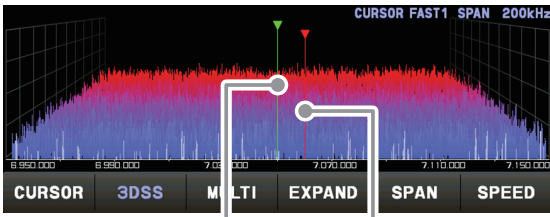

Receive Frequency Transmit Frequency

• COLOR

The display color of the scope screen can be changed.

Press the [FUNC] knob then touch [COLOR], then touch the desired color from the color selection screen.

The Display Color selection screen will disappear automatically after about 5 seconds.

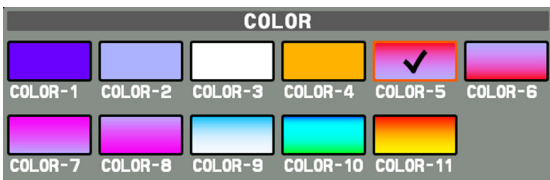

• Adjust contrast

Adjust the contrast of the TFT display.

Press the [FUNC] knob then touch [CONTRAST], and then turn the [FUNC] knob to adjust the contrast.

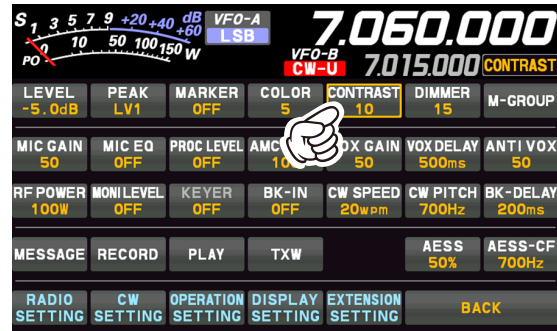

• Adjusting the brightness (DIMMER)

Adjust the brightness of the TFT display.

Press the [FUNC] knob then touch [DIMMER], and then turn the [FUNC] knob to adjust the brightness.

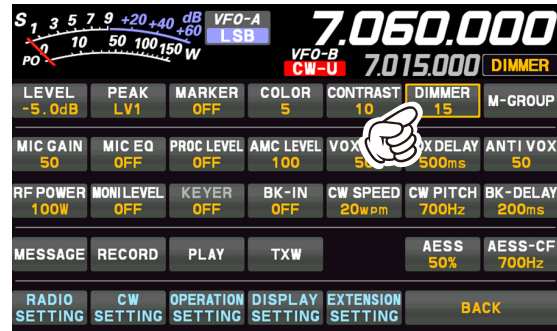

Other display settings

• Screen Saver

A Screen saver, to prevent burning of the TFT screen will operate after a set time, if no transceiver function is operated.

1. Press the [FUNC] knob.
2. Touch [DISPLAY SETTING] or rotate the [FUNC] knob to select [DISPLAY SETTING] and then press the [FUNC] knob.

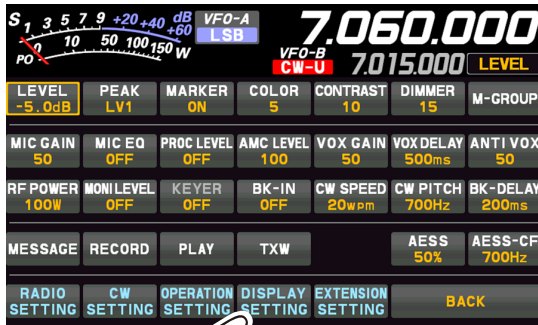

3. Touch [DISPLAY] → [SCREEN SAVER] or rotate the [FUNC] knob to select an item and press the [FUNC] knob.

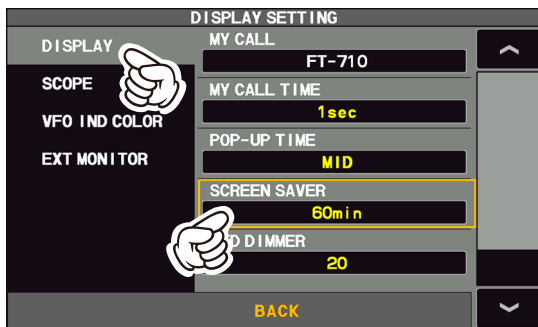

4. Rotate the [FUNC] knob, or touch “<” or “>” on either side of the value to select the time until the screen saver is employed (default setting is 60 min).

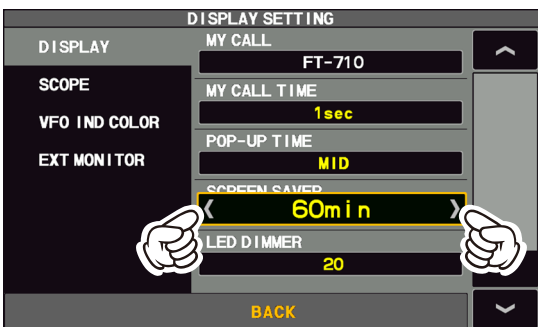

OFF	Screen saver is not employed.
15min	Screen saver activates after 15 minutes.
30min	Screen saver activates after 30 minutes.
60min	Screen saver activates after 60 minutes.

5. Press the [FUNC] knob to save the new setting.
6. Touch [BACK] several times to return to normal operation.

• Inputting the Call Sign

Registered call signs names, and characters can be displayed on the opening screen when the power is turned ON.

1. Press the [FUNC] knob.
2. Touch [DISPLAY SETTING] or rotate the [FUNC] knob to select [DISPLAY SETTING] and then press the [FUNC] knob.



3. Touch [DISPLAY] → [MY CALL] or rotate the [FUNC] knob to select the item and press the [FUNC] knob.

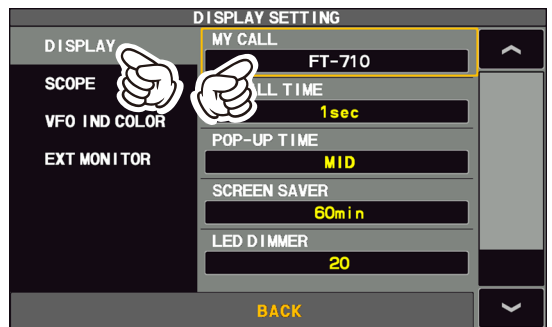

4. Touch a character key. The touched character will be displayed at the top of the screen. Enter each character of your call sign. Up to 12 characters (letters, numbers, and symbols) can be entered.



Caps	The input switches between lower and upper-case letters each time this symbol is touched.
⊗	One character to the left of the cursor is erased when this symbol is touched.
BACK	The display returns to the previous screen when this symbol is touched.

← / →	The cursor in the input field moves left or right when these symbols are touched.
Space	Insert space
ENT	The entered characters are confirmed and the display returns to the previous screen when this symbol is touched.

5. Touch [ENT] to save the new setting and exit to normal operation.

About TFT Displays

FT-710 utilizes a TFT liquid-crystal display.

Although TFT liquid-crystal displays are made using very precise technology, they are prone to develop dead pixels (dark dot) or pixels that are always on (bright dot). Please understand that such phenomena do not constitute product defects or malfunctions. Rather, this phenomenon occurs due to limitations in the manufacturing technology with respect to TFT liquid-crystal displays.

- Depending on the viewing angle, unevenness in color or brightness may occur. Please note that any unevenness observed is inherent to the construction of TFT liquid crystal displays and therefore does not constitute a product defect or malfunction.
- If your TFT liquid-crystal display becomes dirty, please use a dry soft cloth or tissue to wipe the display clean. If it is extremely dirty, moisten it with water or lukewarm water and wipe it off with a soft cloth that has been wrung out tightly. Use of glass cleaner, household cleaners, organic solvents, alcohol, abrasives, and/or like substance may damage the TFT liquid-crystal display.

Front Panel Controls & Switches

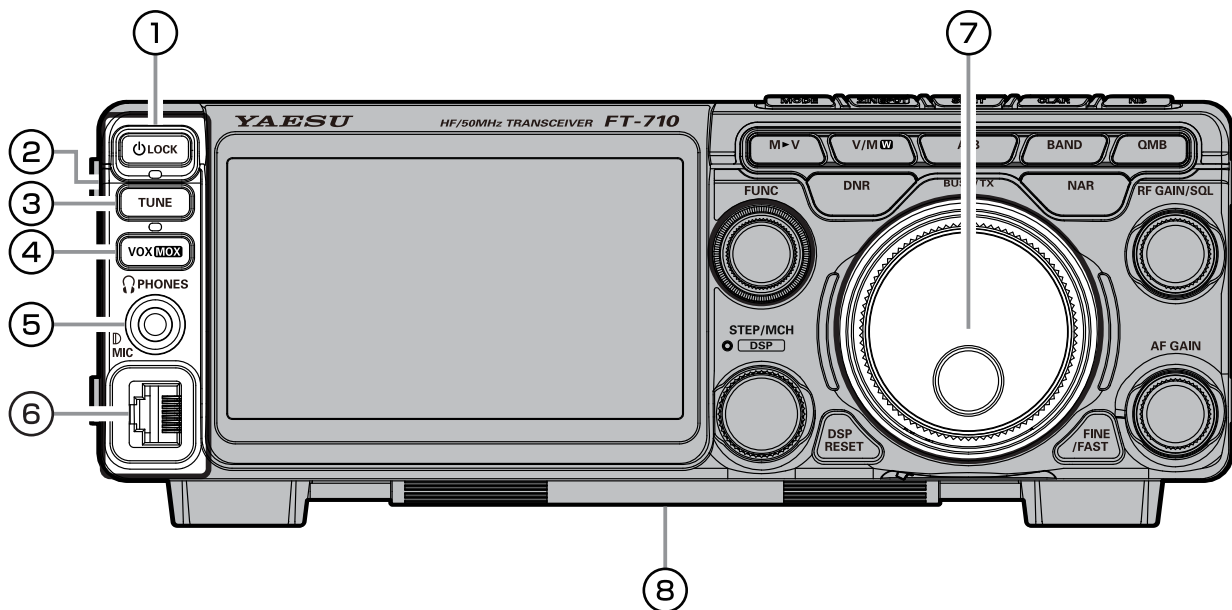

① ON/OFF (LOCK) Switch

Press and hold this switch for one second to turn the transceiver ON or OFF.

Press this key to lock the following actions and prevent accidental frequency or memory channel changes:

- Frequency change with MAIN Dial knob;
- Frequency change and memory channel change with the [STEP•MCH/[DSP]] knob.
("LOCK" appears in the frequency display.)

Press again to unlock.

② SD memory card slot

A commercially available SD memory card may be used to save transceiver settings, to save the memory contents, to screen capture and to update the firmware.



- The SD card is not provided with the product.
- Not all SD cards sold commercially are guaranteed to work with this transceiver.

③ TUNE

This is the ON/OFF switch for the FT-710 Automatic Antenna Tuner.

Press the [TUNE] key briefly to activate the antenna tuner. Press the [TUNE] key briefly again to disable the antenna tuner.

Press the [TUNE] key for about 1 second to start "automatic tuning".



Since the transceiver transmits automatically during automatic tuning, make sure to connect an antenna or dummy load before tuning up.



When the antenna or dummy load does not match the impedance, "HI-SWR" will appear on the touch panel.

④ VOX/MOX

VOX

This key enables automatic voice-actuated transmitter switching. While VOX is activated, the LED inside this key glows orange.

1. Press the [VOX] key.
VOX feature is activated
2. Without pressing the PTT switch, speak into the microphone in a normal voice level. When you start speaking, the transmitter should be activated automatically.
When you finish speaking, the transceiver should return to the receive mode (after a short delay).

To cancel VOX and return to PTT operation, press the [VOX] key once more.

• Adjusts the VOX GAIN

The VOX Gain may be adjusted to prevent unintended transmitter activation in a noisy environment. To adjust the VOX Gain:

1. Press the [FUNC] knob.
2. Touch [VOX GAIN].
3. While speaking into the microphone, rotate the [FUNC] knob to the point where the transmitter is quickly activated by your voice, without background noise causing the transmitter to activate.

• Adjusts the VOX Delay Time

The "Hang-Time" of the VOX system (the transmit-receive delay after the cessation of speech) may also be adjusted.

To set a different delay time:

1. Press the [FUNC] knob.
2. Touch [VOX DELAY].
3. Rotate the [FUNC] knob while saying a brief syllable like "Ah" and listening to the hang time for the desired delay.

• Adjusts the VOX anti-trip sensitivity

The Anti-Trip setting sets the negative feedback of receiver audio to the microphone, to prevent receiver audio from activating the transmitter (via the microphone).

1. Press the [FUNC] knob.
2. Touch [ANTI VOX] .
3. Rotate the [FUNC] knob to prevent receiver audio from activating the transmitter (via the microphone).

MOX

Press and hold this key engages the PTT (Push to Talk) circuit to activate the transmitter.

⑤ PHONES Jack

Connect headphones to this standard $\phi 3.5$ stereo jack.

Inserting a headphone plug into this jack will deactivate the internal and external speakers.



When wearing headphones, we recommend that you turn the AF Gain levels down to their lowest settings before turning power ON, to minimize the impact on your hearing caused by audio “pops” during switch-on.

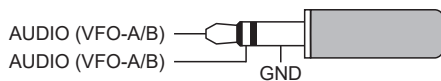

⑥ MIC

This 8-pin jack accepts input from a microphone utilizing the traditional YAESU HF transceiver pinout.

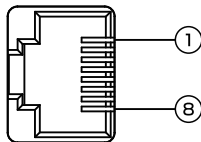

- ① DOWN
- ② UP
- ③ +5V
- ④ MIC GND
- ⑤ MIC
- ⑥ PTT
- ⑦ GND
- ⑧ FAST

⑦ MAIN dial

The MAIN dial sets the operating frequency. Rotate the MAIN dial knob to tune within the band, and begin normal operation.

- The amount of frequency change depends on the operation mode (default setting: see table below).

Operating Mode	1 Step	1 Dial Rotation
LSB / USB CW-L / CW-U	20Hz [1Hz] (100Hz)	4kHz [200Hz] (40kHz)
DATA-L / DATA-U RTTY-L / RTTY-U PSK	10Hz [1Hz] (100Hz)	2kHz [200Hz] (20kHz)
AM / AM-N FM / FM-N DATA-FM / D-FM-N	100Hz [10Hz] (1kHz)	20kHz [2kHz] (200kHz)

“[FINE]” & “[FAST]” settings are ON. (These settings may be changed in the Setting Menu.)

SSB/CW mode

“SSB/CW DIAL STEP”

RTTY/DATA mode

“RTTY/PSK DIAL STEP”

Adjusting the Main tuning DIAL torque

The torque (drag) of the Main DIAL knob may be adjusted for operating preferences. Slide the lever on the bottom side of the transceiver clockwise to reduce the drag, or counter-clockwise to increase the drag.

⑧ WIRE STAND

The heavy wire stand on the bottom of the transceiver allows the transceiver to be tilted upward for better viewing. Simply fold the stand forward to raise the front of the transceiver, and fold it back against the bottom case to lower the front of the FT-710.

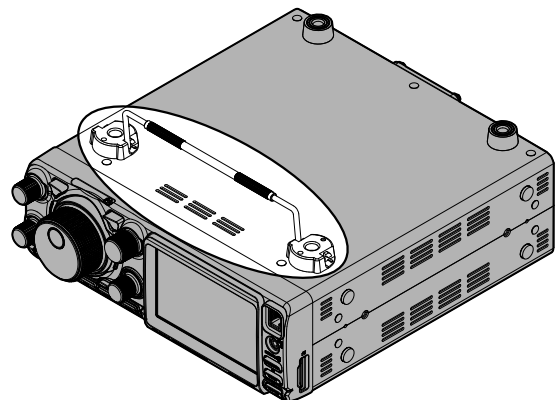

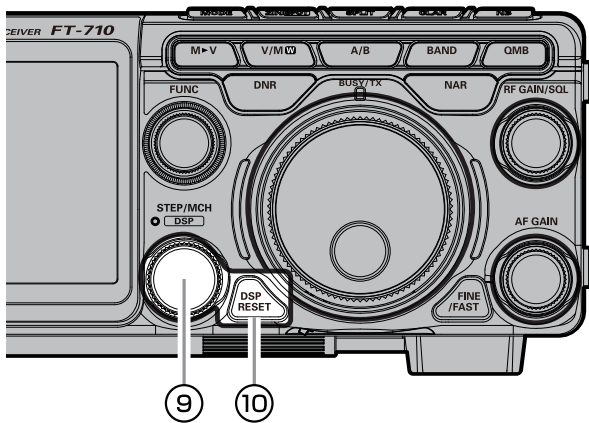

9 STEP•MCH / DSP

•STEP

Turning the [STEP•MCH / DSP] knob changes the frequency in 5kHz steps (factory default settings). The frequency step of the step dial function can be changed by the following operation.

1. Press the [FUNC] knob.
2. Select [OPERATION SETTING] → [TUNING] → [CH STEP].
3. Rotate the [FUNC] knob, or touch “<” or “>” on either side of the value to select a frequency step. Select from 1kHz/2.5kHz/5kHz/10kHz.
4. Press the [FUNC] knob, or wait for about 3 seconds to save the setting.
5. Touch [BACK] several times to return to normal operation.

•MCH

Turning the [STEP•MCH / DSP] knob in memory mode, and it will switch the memory channels.

DSP interference removal functions

Pressing this knob momentarily, exchanges the SHIFT, WIDTH, NOTCH, CONTOUR and APF.

These functions can be operated individually for VFO-A and VFO-B, on each operating band.

1. SHIFT

IF SHIFT permits moving the Digital filter passband higher or lower, without changing the pitch of the incoming signal, and thus reduce or eliminate interference. Because the tuned carrier frequency is not varied, there is no need to re-tune the operating frequency to eliminate the interference.

The total passband tuning range for the IF SHIFT system is $\pm 1.2\text{kHz}$.

2. WIDTH

The IF WIDTH tuning system allows you to vary the width of the DSP IF passband, to reduce or eliminate interference.

Moreover, the bandwidth may actually be expanded from its default setting, should you wish to enhance incoming signal fidelity when interference on the band is low.

3. NOTCH

The IF NOTCH filter is a highly effective system that allows removing an interfering beat note or other carrier signal from within the receiver passband.

4. CONTOUR

The Contour filter system provides a gentle perturbation of the IF filter passband. The Contour is set to either suppress, or boost specific frequency components, and thus enhances the sound and readability of a received signal

5. APF

During CW operation, when interference or noise is present, the center frequency is automatically set to the PITCH frequency, making it easier to hear the desired signal

• Setting method

1. Press the [STEP•MCH / DSP] knob or touch the spectrum area. The LED of the [STEP•MCH / DSP] knob lights orange.



2. Rotate the [STEP•MCH / DSP] knob to select the function, then press the [STEP•MCH / DSP] knob. (The function may also be selected by touching the function name.)
3. While the set value blinks, rotate the [STEP•MCH / DSP] knob to set the desired value.
4. Press the [STEP•MCH / DSP] key and then press the [DSP RESET] key to confirm the setting.

1. SHIFT



1. Press the [STEP•MCH/(DSP)] knob.
2. Rotate the [STEP•MCH/(DSP)] knob to select "SHIFT", then press the [STEP•MCH/(DSP)] knob. (The function may also be selected by touching "SHIFT".)
The shift frequency blinks.
3. Rotate the [STEP•MCH/(DSP)] knob to the left or right to reduce interfering signals.
4. Press the [STEP•MCH/(DSP)] knob, then press the [DSP RESET] key or wait for about 5 seconds to save the setting.
Press and hold the [STEP•MCH/(DSP)] knob to quickly move the filter passband to center.

Refer to Figure "A" and notice the depiction of the IF DSP filter as a thick line in the center of the passband. In Figure "B", you can see the effect of rotating the [STEP•MCH/(DSP)] knob. The interference level is reduced by moving the filter passband so that the interference is outside of the passband.

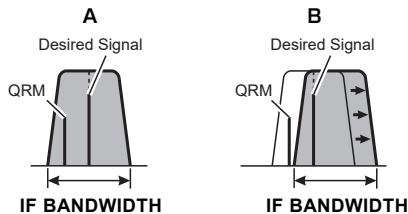

2. WIDTH

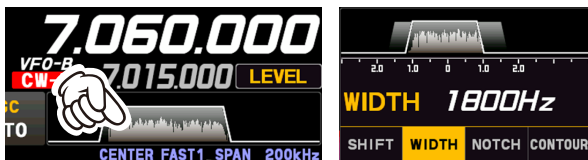

1. Press the [STEP•MCH/(DSP)] knob.
2. Rotate the [STEP•MCH/(DSP)] knob to select "WIDTH", then press the [STEP•MCH/(DSP)] knob. (The function may also be selected by touching "WIDTH".)
The filter bandwidth blinks.
3. Rotate the [STEP•MCH/(DSP)] knob counter-clockwise to narrow the bandwidth and reduce interference.
4. Press the [STEP•MCH/(DSP)] knob, then press the [DSP RESET] key or wait for about 5 seconds to save the setting.
Press and hold the [STEP•MCH/(DSP)] knob to reset the digital filter bandwidth to its initial value.

The default bandwidths, and total bandwidth adjustment range, will vary according to the operating mode (see table below).

Operating Mode	IF BANDWIDTH
LSB / USB	300Hz - 4000Hz (default: 3000Hz)
CW-L / CW-U RTTY-L / RTTY-U	50Hz - 4000Hz (default: 500Hz)
DATA-L / DATA-U PSK	50Hz - 4000Hz (default: 600Hz)
AM / FM-N / D-FM-N	9000Hz
AM-N	6000Hz
FM / DATA-FM	16000Hz

The figure below is a conceptual diagram of WIDTH.

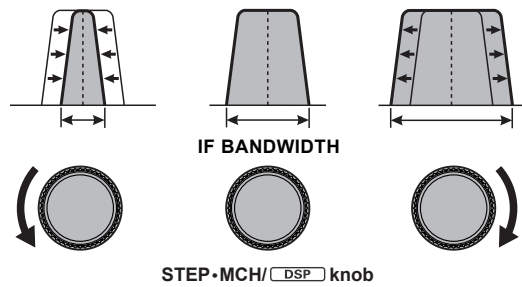

3. NOTCH

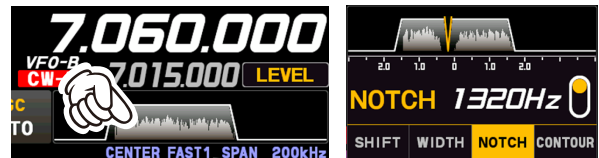

1. Press the [STEP•MCH/(DSP)] knob.
2. Rotate the [STEP•MCH/(DSP)] knob to select "NOTCH", then press the [STEP•MCH/(DSP)] knob. (The function may also be selected by touching "NOTCH".)
The NOTCH center frequency blinks.
3. Rotate the [STEP•MCH/(DSP)] knob to adjust the "null" position of the Notch filter.
4. Press the [STEP•MCH/(DSP)] knob, then press the [DSP RESET] key or wait for about 5 seconds to save the setting.
Press and hold the [STEP•MCH/(DSP)] knob to return the center frequency to its initial value.

i The bandwidth of the NOTCH filter (either narrow or wide) may be adjusted using Menu item "IF NOTCH WIDTH" (page 92).
The factory default setting is "WIDE".

The performance of the IF Notch filter is shown in Figure "A", where the effect of rotation of the [STEP•MCH/(DSP)] knob is depicted. In Figure "B" you can see the notching effect of the IF Notch filter as you rotate the [STEP•MCH/(DSP)] knob to eliminate the incoming interference.

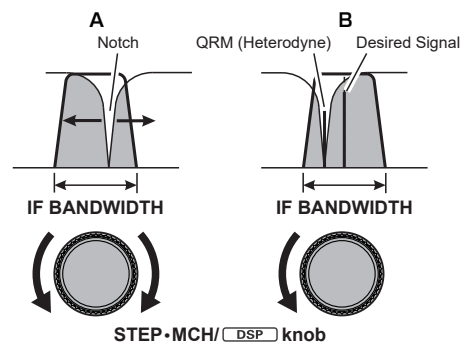

4. CONTOUR



1. Press the [STEP•MCH/⟳DSP] knob.
2. Rotate the [STEP•MCH/⟳DSP] knob to select "CONTOUR", then press the [STEP•MCH/⟳DSP] knob.
(The function may also be selected by touching "CONTOUR".)
The center frequency of "CONTOUR" blinks.

i If "CONTOUR" is not displayed, select "APF" and press the [STEP•MCH/⟳DSP] knob to display "CONTOUR".

3. Rotate the [STEP•MCH/⟳DSP] knob to achieve the most natural-sounding audio reproduction of the incoming signal.
4. Press the [STEP•MCH/⟳DSP] knob, then press the [DSP RESET] key or wait for about 5 seconds to save the setting.
Press and hold the [STEP•MCH/⟳DSP] knob to return the center frequency to its initial value.

The figure below is a conceptual diagram of CONTOUR.

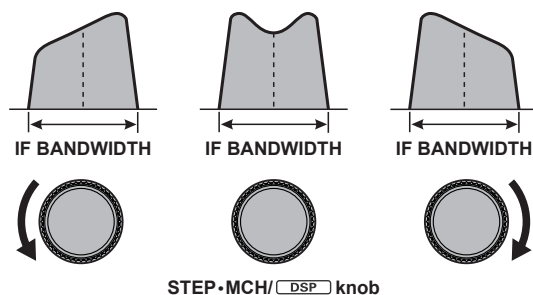

• Adjusting the GAIN of the CONTOUR Circuit

1. Press the [FUNC] knob.
2. Select [OPERATION SETTING] → [RX DSP] → [CONTOUR LEVEL].
3. Rotate the [FUNC] knob, or touch "<" or ">" on either side of the value to set the CONTOUR circuit gain.
4. Press the [FUNC] knob, or wait for about 3 seconds to save the setting.
5. Touch [BACK] several times to return to normal operation.

• Sets the Bandwidth ("Q") of the CONTOUR Circuit

1. Press the [FUNC] knob.
2. Select [OPERATION SETTING] → [RX DSP] → [CONTOUR WIDTH].
3. Rotate the [FUNC] knob, or touch "<" or ">" on either side of the value to set bandwidth ("Q") of the CONTOUR circuit.
4. Press the [FUNC] knob, or wait for about 3 seconds to save the setting.
5. Touch [BACK] several times to return to normal operation.

5. APF

The APF function can be operated individually for VFO-A and VFO-B, on each operating band (The settings are common to VFO-A and VFO-B, and each operating band).



1. Press the [STEP•MCH/⟳DSP] knob.
2. Rotate the [STEP•MCH/⟳DSP] knob to select "APF", then press the [STEP•MCH/⟳DSP] knob.
(The function may also be selected by touching "APF".)
The center frequency of APF blinks.

- If "APF" is not displayed and CONTOUR is displayed, and it is **OFF**. Select CONTOUR and press the [STEP•MCH/⟳DSP] knob 3 times to active "APF".
- If "APF" is not displayed and CONTOUR is displayed, and it is **ON**. Select CONTOUR and press the [STEP•MCH/⟳DSP] knob 3 times to active "APF".

3. Rotate the [STEP•MCH/⟳DSP] knob to the left or right to reduce any interference.
4. Press the [STEP•MCH/⟳DSP] knob, then press the [DSP RESET] key or wait for about 5 seconds to save the setting.
5. Press and hold the [STEP•MCH/⟳DSP] knob to restore the APF peak center frequency setting to "0Hz", and disable the APF function.

i The APF bandwidth can be selected from NARROW / MEDIUM / WIDE via the Menu item "APF WIDTH" (page 92).

⑩ DSP RESET

Press and hold the [DSP RESET] key to reset to the default values of the "SHIFT", "WIDTH", "NOTCH", "CONTOUR", and "APF" settings for the current band. A short press while setting "SHIFT", "WIDTH", "NOTCH", "CONTOUR" or "APF" confirms the setting and returns to the normal screen.

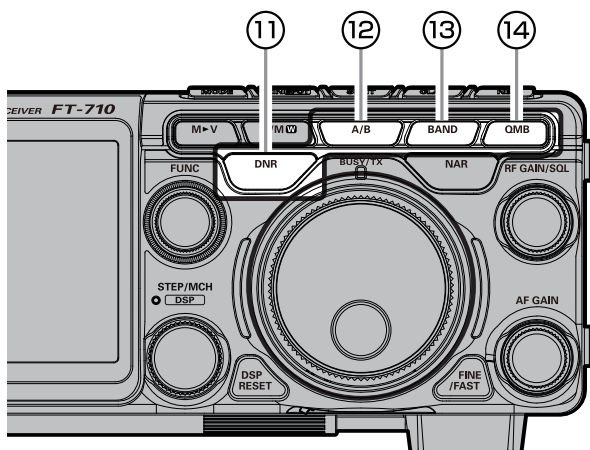

11 DNR (Digital Noise Reduction)

The Digital Noise Reduction (DNR) system is designed to reduce the level of ambient noise found on the HF and 50 MHz bands. The (DNR) system is especially effective during SSB operation. Any of 15 different noise-reduction algorithms can be selected; each of these algorithms was created to deal with a different noise profile. You will want to experiment with the DNR system to find the best setting corresponding to the noise currently being experienced.

The DNR function can be operated individually for VFO-A band and VFO-B.

Press the [DNR] key to enable the DNR operation. To disable DNR operation, press the [DNR] key once more.

• Adjusting the DNR Level



1 Press and hold the [DNR] key to display the DNR level.

2 Turn the [FUNC] knob to adjust the DNR level.

3 After adjusting to a DNR level, the DNR level display disappears after about 3 seconds.

After adjusting the DNR level, the operation of the [FUNC] knob returns to the operation that was used before adjusting the DNR level.

12 A/B

Pressing this key momentarily, exchanges the VFO-A and VFO-B frequency data. Press and hold this key, and the frequency displayed in gray in the lower row becomes the same as the frequency displayed in white in the upper row. The operation will be the same mode as the upper row.

13 BAND (Operating Band Selection)

1 Touch the display to select

Press the [BAND] key, the operation band selection screen appears on the display, so touch the desired band. When you touch it, the band will be confirmed for about 1 second and then return to the operating screen.

2 Rotate the [FUNC] knob to select

Press the [BAND] key, the operation band selection screen appears on the display. Rotate the [FUNC] knob to select the desired band.

BAND			
1.8	3.5	5.0	7.0
10	14	18	21
24.5	28/29	50	70/GEN

14 QMB (Quick Memory Bank)

The current operation status can be stored in a dedicated memory channel (QMB: Quick Memory Bank) with one touch.

• QMB Channel Storage

i The initial number is 5 QMB memories, but this can be increased to 10 channels.

1. Tune to the desired frequency on the VFO mode.
2. Press and hold the [QMB] key. The “beep” will confirm that the VFO contents have been written to the currently available QMB memory.

i

- Repeated pressing and holding of the [QMB] key will write the VFO contents to successive QMB memories.
- Once all five (or ten) QMB memories have data on them, previous data will be over-written on a first-in, first-out basis.

• QMB Channel Recall

1. Press the [QMB] key.
The current QMB channel data will be shown on the frequency display area.
The “VFO” or “Memory Channel number” will be replaced by “QMB”.
2. Repeatedly pressing the [QMB] key will step through the QMB channels:
3. Press the [V/M] key to return to the VFO mode.

• Changing the number of QMB channels

The QMB channels can be selected from “5 channels” or “10 channels”.

1. Press the [FUNC] knob.
2. Select [OPERATION SETTING] → [GENERAL] → [QMB CH].
3. Select “5ch” or “10ch”.
4. Press the [FUNC] knob, or wait for about 3 seconds to save the setting.
5. Touch [BACK] several times to return to normal operation.

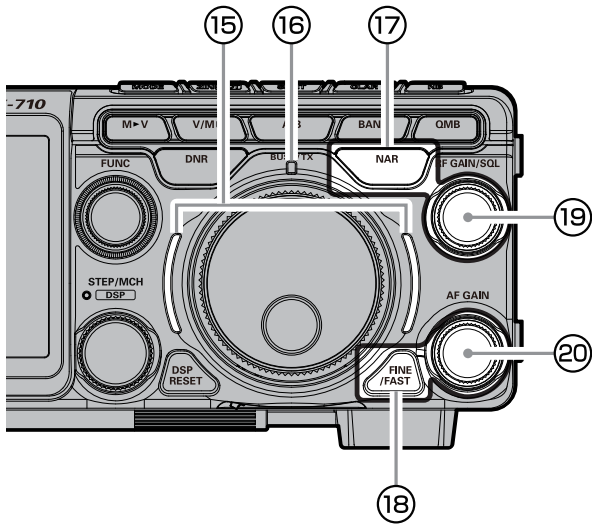

15 VMI (VFO mode indicator)

Shows the current operating status of the VFO at a glance. The indicator lights up in the following colors according to the operating status (factory default settings).

Blue: VFO-A
 Green: VFO-B
 White: Memory mode
 Red: Clarifier or Split Operation

The lighting colors can be changed by the following operations:

1. Press the [FUNC] knob.
2. Select [DISPLAY SETTING] → [VFO IND COLOR].
3. Select the item whose color you want to change.
4. Rotate the [FUNC] knob, or touch "<" or ">" on either side of the value to select the Color. Select the color of the "✓" mark in the table below for each item.

	Blue	Green	Red	White	None
VFO-A	✓	✓	✓	-	✓
VFO-B	✓	✓	✓	-	✓
Memory mode	✓	✓	-	✓	✓
Clarifier / Split	-	-	✓	-	✓

5. Press the [FUNC] knob, or wait for about 3 seconds to save the setting.
6. Touch [BACK] several times to return to normal operation.

16 BUSY/TX indicator

This indicator glows green* when the squelch opens, and glows red during transmit.

* Glows green only when the [RF GAIN/SQ] knob is set to "SQL" or "SQL(FM only)".

17 NAR (Narrow)

This key is used to set the DSP (digital) IF filters to Narrow bandwidth. Press this key again to return the bandwidth control to the WIDTH system.

• Change the bandwidth by pressing the NAR key

1. Press the [FUNC] knob.
2. The setting menu items to be set differ depending on the operating mode, so call the setting items referring to the following:

LSB / USB mode

[RADIO SETTING] → [MODE SSB] →
 → [NAR WIDTH]

CW-L / CW-U mode

[CW SETTING] → [MODE CW] → [NAR WIDTH]

DATA-L / DATA-U / PSK mode

[RADIO SETTING] → [MODE PSK/DATA] →
 → [NAR WIDTH]

RTTY-L / RTTY-U mode

[RADIO SETTING] → [MODE RTTY] →
 → [NAR WIDTH]

3. Rotate the [FUNC] knob, or touch "<" or ">" on either side of the value to set the bandwidth.

Mode	Available Settings (Default: Bold)
LSB / USB	300 - 1500 - 4000
CW-L / CW-U	50 - 250 - 4000
DATA-L / DATA-U RTTY-L / RTTY-U PSK	50 - 300 - 4000

4. Press the [FUNC] knob, or wait for about 3 seconds to save the setting.
5. Touch [BACK] several times to return to normal operation.

18 FINE/FAST

FINE Tuning (Tuning of 1Hz)

In the LSB, USB, CW-L, CW-U, DATA-L, DATA-U, RTTY-L, RTTY-U or PSK mode, the frequency can be adjusted in 1 Hz steps.

- The AM, AM-N, FM, FM-N, DATA-FM and D-FM-N modes may be adjusted in 10 Hz steps.

1. Press the [FINE/FAST] key. The "FINE" indicator lights in the display.
2. Rotate the MAIN dial knob.
3. Press the [FINE/FAST] key again to return to the original frequency step.

FAST Tuning (Tuning of 10 times)

The frequency can be adjusted in 10 times steps.

1. Press and hold the [FINE/FAST] key. The "FAST" indicator lights in the display.
2. Rotate the MAIN dial knob.
3. Press the [FINE/FAST] key again to return to the original frequency step.

19 RF GAIN/SQL

RF (default setting)

The RF Gain control provides manual adjustment of the gain levels for the receiver RF and IF stages, to account for noise and signal strength conditions at the moment.

[RF GAIN/SQL] knob is normally in the fully clockwise position.



- Before operation, set the operation of the [RF GAIN/SQL] control to “RF” (see below). The default setting is “RF”.
- It does not operate in FM/FM-N/DATA-FM and D-FM-N mode.

SQL

The squelch system allows the back-ground noise to be muted when no signal is being received.

Normally, the squelch is not used during SSB or CW operation.



- Before operation, set the operation of the [RF GAIN/SQL] control to “SQL”. The default setting is “RF”.

Rotate the [RF GAIN/SQL] knob to adjust the squelch until the noise disappears.



- If the squelch knob is turned too far to the right, weak signals cannot be heard

• Switching the operation of the

[RF GAIN/SQL] knob

1. Press the [FUNC] knob.
2. Select [OPERATION SETTING]→[GENERAL] → [RF/SQL VR].
3. Select “RF” or “SQL”.
4. Press the [FUNC] knob, or wait for about 3 seconds to save the setting.
5. Touch [BACK] several times to return to normal operation.



RF GAIN/SQL settings cannot be set separately for the VFO-A and the VFO-B.

20 AF GAIN

Sets the audio level.

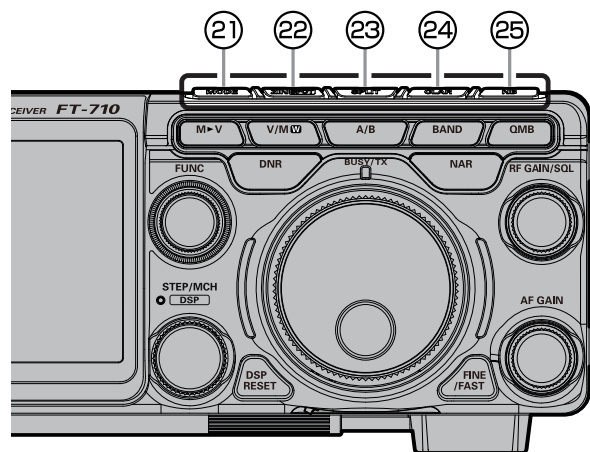

21 MODE (Operating Mode Selection)

① Touch the display to select

Press the [MODE] key or touch the operation mode area, the operation mode selection screen appears on the display, so touch the desired mode.



② Rotate the [FUNC] knob to select

Press the [MODE] key or touch the operation mode area, the operation mode selection screen appears on the display. Rotate the [FUNC] knob to select the desired mode.



- Touch [PRESET] to display the settings that apply to the FT8 operation.
- When changing modes from SSB to CW, the frequency will shift on the display, even though the actual tone that is heard does not change.



This shift represents the BFO offset between the “zero beat” frequency and the audible CW pitch (tone). The pitch is programmed via Menu item “CW FREQ DISPLAY”.

22 ZIN/SPOT

ZIN

Press the [ZIN/SPOT] switch momentarily to adjust the receiving frequency and zero-in automatically while receiving a CW signal.

SPOT

While pressing and holding [ZIN/SPOT], the tone is output from the speaker. This tone corresponds to the pitch of your transmitted signal. If you adjust the receiver frequency until the pitch of the received CW signal matches that of the Spot tone, the transmitted signal will be precisely matched to that of the other station.

The Spot tone audio level may be adjusted by pressing the [FUNC] knob, then touching [MONI LEVEL], and rotating the [FUNC] knob.

23 SPLIT

A powerful capability of the FT-710 is its flexibility in Split Frequency operation using the VFO-A and VFO-B frequency registers. This makes the FT-710 especially useful for high-level DX-peditions. The Split operation capability is very advanced and easy to use.

1. Press the [A/B] key, then set the upper VFO frequency to the desired receive frequency.
2. Press the [SPLIT] key, and then set the lower VFO frequency to the desired transmit frequency.

During Split operation, the upper VFO register will be used for reception, while the lower VFO register will be used for transmission. Press the [SPLIT] key again to cancel Split operation.

- Rotate the main dial while holding down the [STEP•MCH/□DSP] knob during split operation will change the transmit and receive frequencies in the same step at the same time.
- The receive and transmit frequencies can be set to different bands or operation modes.
- During split operation, touch [TXW] after pressing the [FUNC] knob, to receive the transmit frequency while pressing the [FUNC] knob.
- Press and hold the [SPLIT] key to change the receive frequency.

24 CLAR (Clarifier)

The clarifier is used to adjust the transceiver receive frequency to match the other station transmit frequency and improve the audio; or to shift the transmit frequency of this station when the transmit frequency of the contact station is shifted.

The display will indicate “CLAR RX” → “CLAR TX” → “CLAR RXTX” in red, each time the [CLAR] key is pressed, and the clarifier will activate.

Turning the MAIN dial changes the clarifier offset frequency.

To turn the clarifier OFF, repeatedly press the [CLAR] key until the Clarifier status is not displayed.

To clear out the programmed clarifier offset altogether, and reset it to “zero,” press and hold the [CLAR] key.

• RX Clarifier

If the transmit frequency of the contact station deviates, this receiver clarifier frequency can be changed leaving this transmit frequency unchanged.

1. Press the [CLAR] key.
2. Rotate the MAIN dial knob to change only the receive frequency.

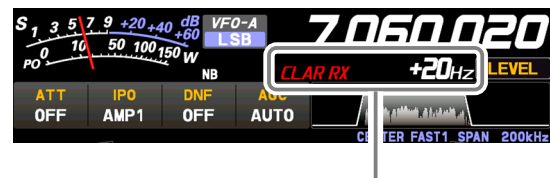

When the receive frequency is offset by +20Hz.

i Offsets of up to ±9995Hz may be set using the Clarifier.

3. To cancel Clarifier operation, press the [CLAR] key three times.
- Since the offset amount is memorized, when the clarifier function is operated again, the same offset amount is set.

• Adjust transmit frequency to the offset frequency

After changing the receiver frequency with RX Clarifier, the transmitter frequency can be set to the same frequency as the receiver.

1. After offsetting the receiver frequency, press the [CLAR] key twice.
The transmit frequency becomes the same as the receive frequency.
“CLAR RX” of the display changes to “CLAR RXTX”.
2. Press the [CLAR] key twice, only the receive frequency returns to the offset state.
“CLAR RXTX” of the display changes to “CLAR RX”.

• TX Clarifier

The transmit frequency can be changed without moving the receive frequency of the transceiver. Normally, the clarifier is used to move only the receive frequency and compensate for the deviation of the transmission frequency of the contact station, however alternatively, only the transmit frequency can be moved without changing the transmitter. When responding to an operator that is called by a large number of stations such as in a contest, etc., the response rate may increase if the transmit frequency is moved slightly.

1. Press the [CLAR] key twice.
2. Rotate the MAIN dial knob to change only the transmit frequency.



- The “CLAR TX” will appear in the display, and the programmed offset will be applied to the transmit frequency.
- Offsets of up to $\pm 9995\text{Hz}$ may be set using the Clarifier.

3. To cancel Clarifier operation, press the [CLAR] key twice.

To clear out the programmed clarifier offset altogether, and reset it to “zero”, press and hold the [CLAR] key.

• To offset the frequency with the TX Clarifier Adjust receive frequency

When the transmit frequency is offset with the TX Clarifier, it can be reset to the same frequency as the TX frequency offset from the receive frequency.

1. After offsetting the transmit frequency, press the [CLAR] key.
The receive frequency becomes the same as the transmit frequency.
“CLAR TX” of the display changes to “CLAR RXTX”.
2. Press the [CLAR] key three times, only the transmit frequency returns to the offset state.
“CLAR RXTX” of the display changes to “CLAR TX”.

25 NB

The FT-710 includes an effective IF Noise Blanker, which can significantly reduce noise caused by automotive ignition systems.

The NB function can be operated individually for VFO-A band and VFO-B, on each operating band.

Press the [NB] key to enable the Noise Blanker operation. To disable Noise Blanker operation, press the [NB] key once more.

• Adjusting the Noise Blanker Level

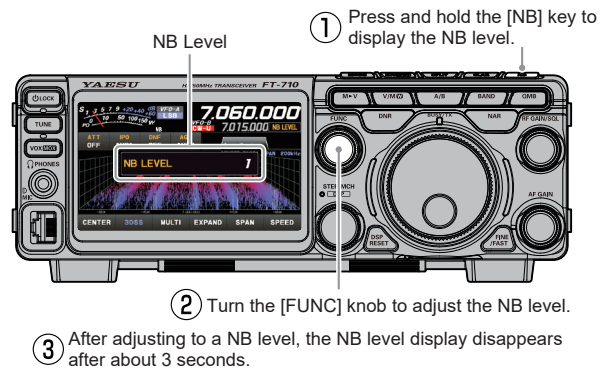

The NB function may be less effective on some other types of interference.

• Adjusting the Noise Attenuation

1. Press the [FUNC] knob.
2. Select [OPERATION SETTING]→[RX DSP]→[NB REJECTION].
3. Rotate the [FUNC] knob to set the noise attenuation (LOW / MID / HIGH).
4. Press the [FUNC] knob, or wait for about 3 seconds to save the setting.
5. Touch [BACK] several times to return to normal operation.

• Reduces longer duration pulse noise

Reduces long duration noise as well as pulse noise.

1. Press the [FUNC] knob.
2. Select [OPERATION SETTING]→[RX DSP]→[NB WIDTH].
3. Rotate the [FUNC] knob to select the value that will reduce the noise.
4. Press the [FUNC] knob, or wait for about 3 seconds to save the setting.
5. Touch [BACK] several times to return to normal operation.

Voice Communications (SSB and AM)

When transmitting in SSB or AM mode

The FT-710 transmit audio circuit can be set to the optimum operating level by individually adjusting the input and output gains of the microphone amplifier.

i The AMC (Automatic Microphone Gain Control) regulates the microphone audio so that distortion does not occur, even if excessive audio is input.

1. Adjust Microphone gain

Touch the Meter Display and then touch "ALC" to select the ALC Meter.

1. Press the [FUNC] knob.
2. Touch [MIC GAIN].
3. Key TX and adjust the [FUNC] knob to set the input level of the Microphone Amplifier to the position where the ALC Meter needle does not exceed the ALC zone on the audio peaks.

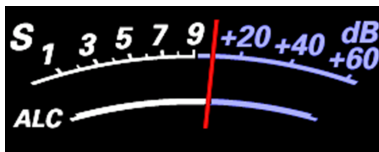
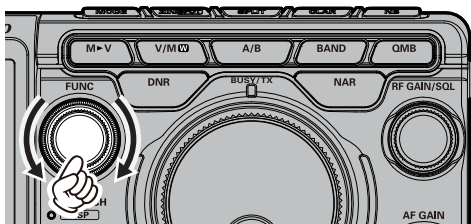

2. Adjust the AMC gain

Touch the Meter Display and then touch "COMP" to select the COMP Meter.

1. Press the [FUNC] knob.
 2. Touch [AMC LEVEL].
 3. Activate the transmit and speak into the microphone while adjusting the AMC level with the [FUNC] knob.
- Adjust the AMC to a point where the COMP Meter deflection does not exceed "10dB" on the audio peaks.

Setup is completed.

! The AMC function only works in LSB, USB, AM, AM-N, DATA-L, DATA-U and PSK modes. It does not work in other modes.

Set with the FUNC knob

Operate the [FUNC] knob to make the following settings.

PROC LEVEL: Adjust the level of the speech processor function.

RF POWER: Adjust the transmit power.

MONI LEVEL: Adjust the monitor level.

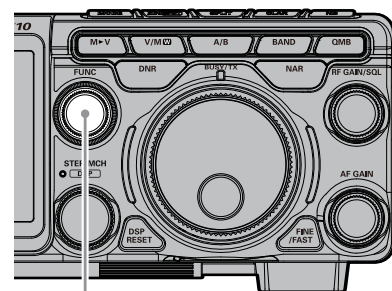
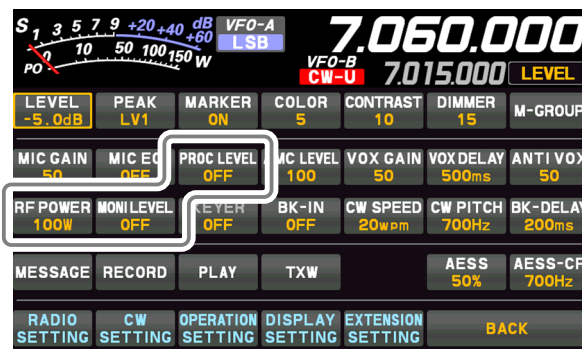

FUNC knob

The last function used is retained in the [FUNC] knob so it can be easily set by operating the [FUNC] knob. Normally, it is suggested to utilize the [FUNC] knob as the [LEVEL] knob for the spectrum scope.

Speech Processor

The FT-710 Speech Processor is designed to increase “talk power” by increasing the average power output of the transmitted SSB signal.



The speech processor function only works in LSB/USB mode. It does not work in other modes.

1. Adjust the MIC gain as described on the previous page.
2. Press the [FUNC] knob.
3. Touch [PROC LEVEL].



4. Touch the Meter area on the display to select the “COMP” meter.
The transmit meter becomes the “COMP” meter.
5. Press the PTT switch on the microphone, and speak into the microphone in a normal voice level.
6. Adjust the [FUNC] knob to set the compression level within 10 dB.
 - The Transmit Monitor is a helpful aid to verify proper adjustment of the Compression level.
 - The “PROC” indicator lights in the display.

Rotate the [FUNC] knob to the left to turn the speech processor function “OFF”.



The speech processor can distort the transmit waveform when used to increase the average TX power, so it is not used in normal communication.

RF Power output control

Turn the [FUNC] knob to adjust the RF power output.

1. Press the [FUNC] knob.
2. Touch [RF POWER].



3. Rotate the [FUNC] knob to adjust the RF power.



When transmitting in the AM mode, set a maximum (carrier) power output of 25 Watts.

Setting of maximum transmission output

The maximum transmit power can be set for each of the HF Bands, the 50MHz band and the AM mode. Set it according to operating conditions, when high transmit power is not needed.

1. Press the [FUNC] knob.
2. Select [OPERATION SETTING] → [TX GENERAL].
3. Rotate the [FUNC] knob to select the item you want to set.

HF MAX POWER (HF band)
(The setting range is 5 to 100 W)

50M MAX POWER (50 MHz band)
(The setting range is 5 to 100 W)

70M MAX POWER (70 MHz band)
(The setting range is 5 to 50 W)

AM MAX POWER (AM mode)
(The setting range is 5 to 25 W)

4. Press the [FUNC] knob, or wait for about 3 seconds to save the setting.
5. Touch [BACK] several times to return to normal operation.

MONI (Monitor)

Use the Monitor feature to listen to the quality of the transmitted signal.

1. Press the [FUNC] knob.
2. Touch [MONI LEVEL].



3. Rotate the [FUNC] knob to adjust the Monitor level.



Transmit audio monitor is not activate in the FM, FM-N, DATA-FM and D-FM-N modes.

- If you are using the speaker for monitoring, instead of headphones, excessive advancement of the Monitor level can cause feedback to occur. Additionally, this feedback can cause the VOX system to hang up in a loop, making it impossible to return to receive. Therefore, we recommend the use of headphones, if at all possible, or the minimum usable setting of the Monitor level, if the speaker must be used.
4. To cancel the monitor function, turn the [FUNC] knob to set “MONI LEVEL” to “OFF”.
- Because the Monitor feature samples the transmitter IF signal, it can be very useful for checking the adjustment of the Speech Processor or Parametric Equalizer on SSB, and for checking the general signal quality on AM.

Parametric Microphone Equalizer

The FT-710 includes a unique Three-Band Parametric Microphone Equalizer that provides precise, independent control over the low, mid and treble ranges in the voice waveform. One group of settings may be utilized when the Speech Processor is Off, and an alternate group of settings when the Speech Processor is On (SSB mode only). The speech processor feature is described in the next chapter.



Parametric microphone equalizer function is activated only in LSB, USB, AM, AM-N, FM and FM-N modes.

• Setup the Parametric Microphone Equalizer

1. Set the RF output power to minimum value.



We recommend connecting a dummy load to one of the Antenna jacks, and monitoring the signal on a separate receiver, to prevent interference to other users.

2. Press the [FUNC] knob.
3. Touch [MIC EQ].

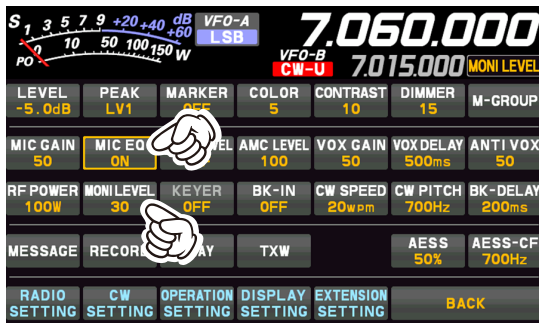

Parametric Microphone Equalizer function is activated.

- To adjust the Parametric Microphone Equalizer with the Speech Processor engaged, activated the Speech Processor.

4. Press the [FUNC] knob.
5. Touch [MONI LEVEL].
6. Rotate the [FUNC] knob to adjust the Monitor level.
7. Press the [FUNC] knob.
8. Select [OPERATION SETTING]→[TX AUDIO].
9. Rotate the [FUNC] knob to find Menu items [PRMTRC EQ1 FREQ] through [PRMTRC EQ3 BWTH]; these parameters apply to the adjustment of the Parametric Microphone Equalizer when the Speech Processor is disabled.
Menu items [P PRMTRC EQ1 FREQ] through [P PRMTRC EQ3 BWTH] apply to the adjustment of the Parametric Microphone Equalizer when the Speech Processor is engaged.
10. Rotate the [FUNC] knob, or touch “<” or “>” on either side of the value to adjust a particular Menu item.
11. Press and hold the PTT switch, and speak into the microphone while listening to the effect of the adjustments being made. Because the overall sound will change with each adjustment, make several passes through each adjustment area, to be sure that the optimum

settings are achieved.

- The best way to hear the effects of the adjustments is to wear headphones (connected to the monitor receiver) while listening to the transmitted signal.
12. When all adjustments are satisfactory, press the [FUNC] knob, or wait for about 3 seconds to save the setting.
 13. Touch [BACK] several times to return to normal operation.

• Activate the Parametric Microphone Equalizer

1. Adjust the MIC gain, as described on page 40.
2. Press the [FUNC] knob.
3. Touch [MIC EQ].
Parametric Microphone Equalizer function is activated.
4. Press the PTT switch on the microphone, and speak into the microphone in a normal voice level.

To cancel the Parametric Microphone Equalizer function, repeat steps 2 and 3 above, and choose “OFF” in step 3.

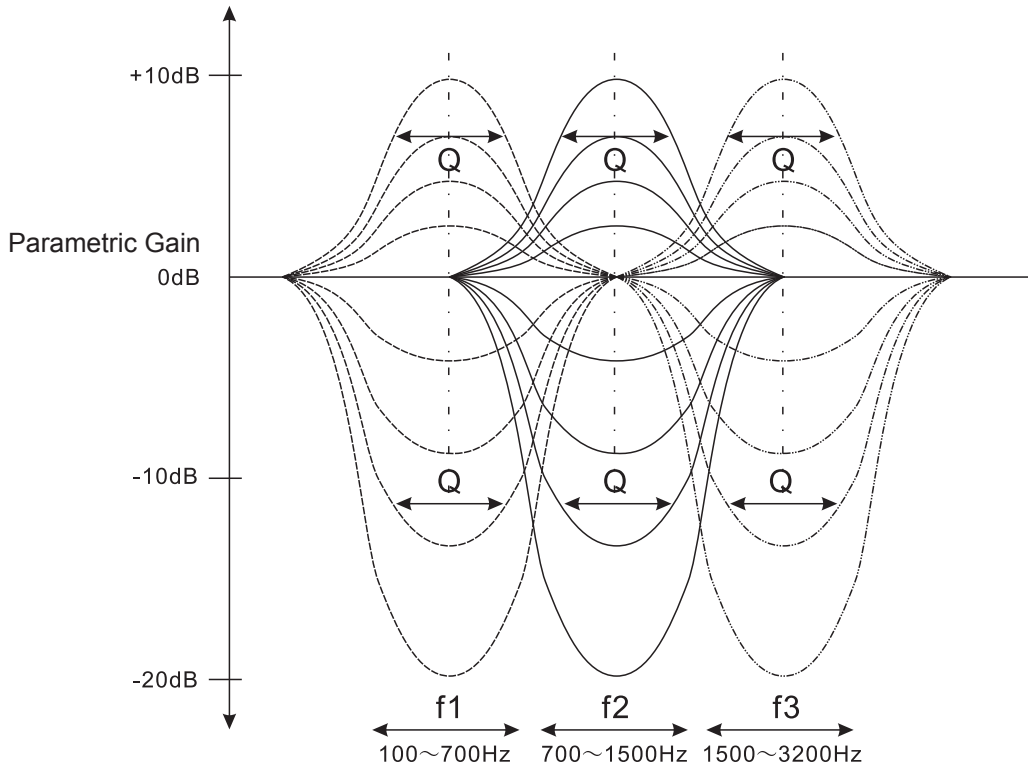

3-Stage Parametric Equalizer Adjustments (Speech Processor: "OFF")

Center Frequency	PRMTRC EQ1 FREQ	(Low) "100" (Hz) - "700" (Hz) / OFF	OFF
	PRMTRC EQ2 FREQ	(Mid) "700" (Hz) - "1500" (Hz) / OFF	
	PRMTRC EQ3 FREQ	(High) "1500" (Hz) - "3200" (Hz) / OFF	
Parametric Gain	PRMTRC EQ1 LEVEL	(Low) "-20" (dB) - "+10" (dB)	+5
	PRMTRC EQ2 LEVEL	(Mid) "-20" (dB) - "+10" (dB)	
	PRMTRC EQ3 LEVEL	(High) "-20" (dB) - "+10" (dB)	
Q (Bandwidth)	PRMTRC EQ1 BWTH	(Low) "0" - "10"	10
	PRMTRC EQ2 BWTH	(Mid) "0" - "10"	
	PRMTRC EQ3 BWTH	(High) "0" - "10"	

3-Stage Parametric Equalizer Adjustments (Speech Processor: "ON")

Center Frequency	P PRMTRC EQ1 FREQ	(Low) "100" (Hz) - "700" (Hz) / OFF	OFF
	P PRMTRC EQ2 FREQ	(Mid) "700" (Hz) - "1500" (Hz) / OFF	
	P PRMTRC EQ3 FREQ	(High) "1500" (Hz) - "3200" (Hz) / OFF	
Parametric Gain	P PRMTRC EQ1 LEVEL	(Low) "-20" (dB) - "+10" (dB)	0
	P PRMTRC EQ2 LEVEL	(Mid) "-20" (dB) - "+10" (dB)	
	P PRMTRC EQ3 LEVEL	(High) "-20" (dB) - "+10" (dB)	
Q (Bandwidth)	P PRMTRC EQ1 BWTH	(Low) "0" - "10"	2
	P PRMTRC EQ2 BWTH	(Mid) "0" - "10"	1
	P PRMTRC EQ3 BWTH	(High) "0" - "10"	

Center Frequency: The center frequency of each of the three bands may be adjusted.

Gain: The amount of enhancement (or suppression) within each band may be adjusted.

Q: The bandwidth over which the equalization is applied may be adjusted.

Voice Memory

The Voice Memory capability of the FT-710 may be used to store and replay often repeated messages. The Voice Memory includes five memories.

The Voice Memory may be operated from the Display Panel, or from the optional FH-2 Remote Control Keypad, which plugs into the rear panel REM jack.



When performing Voice memory, a commercially available SD card is necessary.

• Recording Your Own Voice in Memory

1. Insert a commercially available SD memory card into the SD card slot on the left side of the transceiver.
2. Select the LSB, USB, AM, AM-N, FM or FM-N mode.
When using FH-2, go to step 5.
3. Press the [FUNC] knob.
4. Touch [MESSAGE].
The “MESSAGE MEMORY” screen will be displayed.
5. Touch [MEM] on the display or press the [MEM] key on the FH-2.
A blinking “REC” will appear in the display.



If a [1] through [5] key (see next step) is not pressed within 10 seconds, the memory storage process will be cancelled.

6. Touch [1] through [5] on the display or press any of the FH-2 keys numbered [1] through [5] to select that memory storage register.
7. Press the microphone PTT switch momentarily. The “REC” icon will glow steadily and recording will begin.
 - “REC” lights up on the display while recording is in progress.
 - Remember that the time limit for recording any message is 90 seconds.
8. Release the PTT switch or press the FH-2 [MEM] key to complete the message storage process.

• Checking the Recording

1. Press the [FUNC] knob.
2. Touch [BK-IN] to turn OFF the BK-IN function.
When using FH-2, go to step 4.
3. Touch [MESSAGE].
The “MESSAGE MEMORY” screen will be displayed.
4. Touch [1] through [5] on the display or press the FH-2 [1] through [5] key (whichever register was just recorded in). The “MSG” icon will appear in the display and the audio recorded in the Voice Memory will be heard.
 - To adjust the playback volume level, turn the [FUNC] knob or touch [RX LEVEL] when not playing, and then turn the [FUNC] knob to adjust.

• Transmitting the Recorded Message

1. Select the LSB, USB, AM, AM-N, FM or FM-N mode.
2. Press the [FUNC] knob.
3. Touch [BK-IN] to turn ON the BK-IN function.
When using FH-2, go to step 5.
4. Touch [MESSAGE].
5. Touch [1] through [5] on the display or press the FH-2 [1] through [5] key (whichever memory was recorded in). A “MSG” icon will appear in the display and the message will be transmitted.
 - To adjust the output level during transmit, touch [TX LEVEL] and turn the [FUNC] knob.

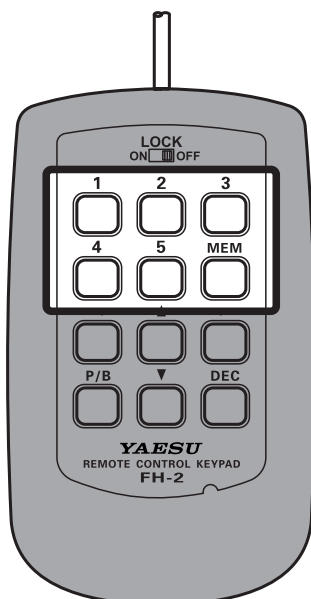

Record the received audio

You can record and play the received audio on the SD memory card.

Record and play of the received audio may be operated from the Display Panel.



- When performing record and play of the received audio, a commercially available SD card is necessary.
- The maximum recording time for one file is about 16 hours. (Maximum file size limit approx. 3.5GB) Recording stops automatically when the maximum file size limit is exceeded.
- Audio files other than those recorded by this unit cannot be played.

• Recording the received audio

1. Insert a commercially available SD memory card into the SD card slot on the left side of the transceiver.
2. Press the [FUNC] knob.
3. Touch [RECORD]. A “S.REC” icon will blink and recording will begin.
The recording time depends on the capacity of the SD memory card used.
4. Touch [STOP] to end recording.
“S.REC” on the display turns OFF.

• Play the recorded content

1. Press the [FUNC] knob.
2. Touch [PLAY].
The “PLAY LIST” screen will be displayed.
3. Rotate the [FUNC] knob to select the file name you want to play.
You can also select it by touching [◀◀] or [▶▶].
4. Touch [▶] to start playback.

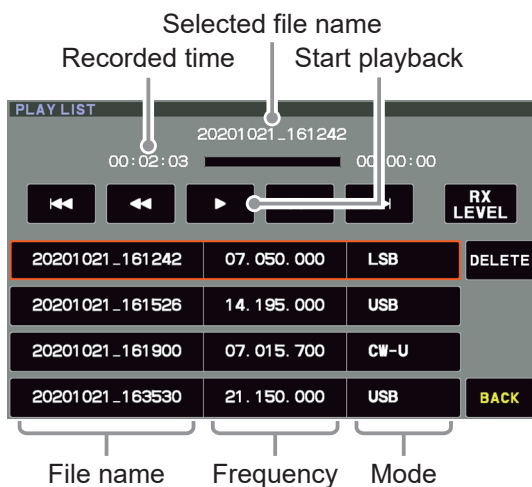

5. Rotate the [FUNC] knob during playback to adjust the volume.
You can also adjust the volume by touching [RX LEVEL] and turning the [FUNC] knob when not playing.

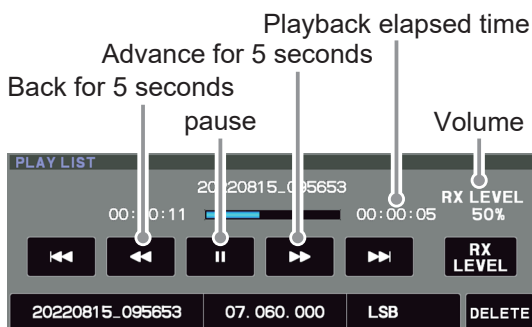

6. Touch [BACK] to return to normal operation.

Adjustable Receiver Audio Filter

The FT-710 incorporates an adjustable receiver audio filter, that affords precision control of the lower and upper audio ranges independently.

1. Press the [FUNC] knob.
2. Select [CW SETTING] for CW mode and [RADIO SETTING] for other modes.
3. Select the Mode and Menu Item you want to set (see table below).
4. Rotate the [FUNC] knob, or touch “<” or “>” on either side of the value to adjust the receiver audio response as desired.
5. Press the [FUNC] knob, or wait for about 3 seconds to save the setting.
6. Touch [BACK] several times to return to normal operation.

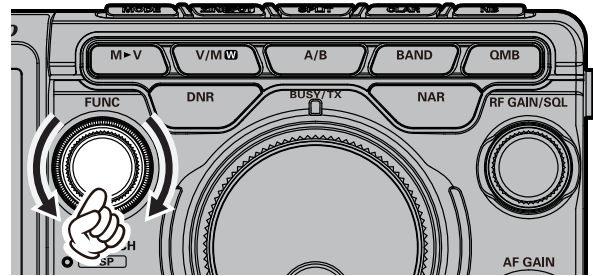

Menu Item		Available Values	Default	
RADIO SETTING	MODE SSB	LCUT FREQ	OFF/100Hz - 1000Hz (50Hz step)	100Hz
		LCUT SLOPE	6dB/oct / 18dB/oct	6dB/oct
		HCUT FREQ	700Hz - 4000Hz (50Hz step)/OFF	3000Hz
		HCUT SLOPE	6dB/oct / 18dB/oct	6dB/oct
	MODE AM	LCUT FREQ	OFF/100Hz - 1000Hz (50Hz step)	OFF
		LCUT SLOPE	6dB/oct / 18dB/oct	6dB/oct
		HCUT FREQ	700Hz - 4000Hz (50Hz step)/OFF	OFF
		HCUT SLOPE	6dB/oct / 18dB/oct	6dB/oct
	MODE FM	LCUT FREQ	OFF/100Hz - 1000Hz (50Hz step)	300Hz
		LCUT SLOPE	6dB/oct / 18dB/oct	18dB/oct
		HCUT FREQ	700Hz - 4000Hz (50Hz step)/OFF	3000Hz
		HCUT SLOPE	6dB/oct / 18dB/oct	18dB/oct
	MODE PSK/DATA	LCUT FREQ	OFF/100Hz - 1000Hz (50Hz step)	100Hz
		LCUT SLOPE	6dB/oct / 18dB/oct	18dB/oct
		HCUT FREQ	700Hz - 4000Hz (50Hz step)/OFF	3200Hz
		HCUT SLOPE	6dB/oct / 18dB/oct	18dB/oct
MODE RTTY	LCUT FREQ	OFF/100Hz - 1000Hz (50Hz step)	300Hz	
	LCUT SLOPE	6dB/oct / 18dB/oct	18dB/oct	
	HCUT FREQ	700Hz - 4000Hz (50Hz step)/OFF	3000Hz	
	HCUT SLOPE	6dB/oct / 18dB/oct	18dB/oct	
CW SETTING	MODE CW	LCUT FREQ	OFF/100Hz - 1000Hz (50Hz step)	250Hz
		LCUT SLOPE	6dB/oct / 18dB/oct	18dB/oct
		HCUT FREQ	700Hz - 4000Hz (50Hz step)/OFF	1200Hz
		HCUT SLOPE	6dB/oct / 18dB/oct	18dB/oct

Change the sound quality of the received audio

You can change each of the high, mid, and low frequencies of the received audio to your liking. It can be set for each mode.

1. Press the [FUNC] knob.
2. Select [CW SETTING] for CW mode and [RADIO SETTING] for other modes.
3. Select the Mode and Menu Item you want to set (see table below).
4. Rotate the [FUNC] knob, or touch “<” or “>” on either side of the value to adjust the level.
5. Press the [FUNC] knob, or wait for about 3 seconds to save the setting.
6. Touch [BACK] several times to return to normal operation.

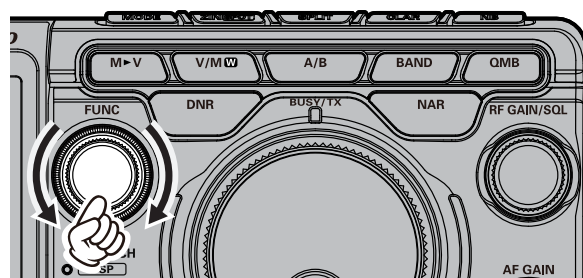

Menu Item		Available Values	Default
RADIO SETTING	MODE SSB	High audio ranges setting → AF TREBLE GAIN	-20 - 10
	MODE AM	Middle audio ranges setting → AF MIDDLE TONE GAIN	
	MODE FM	Low audio ranges setting → AF BASS GAIN	
	MODE PSK/DATA		
	MODE RTTY		
CW SETTING	MODE CW	High audio ranges setting → AF TREBLE GAIN	-20 - 10
		Middle audio ranges setting → AF MIDDLE TONE GAIN	
		Low audio ranges setting → AF BASS GAIN	

Using the Automatic Antenna Tuner

The Automatic Antenna Tuner (ATU) is built into each FT-710. The ATU is designed to ensure that a 50-Ohm antenna impedance load is presented to the final amplifier stage of the transmitter.

- Because the FT-710 ATU is located inside transceiver, it can only adjust the impedance presented to the transceiver end of the coaxial cable feedline. It does not “tune” the SWR at the antenna feed point itself. When designing and building an antenna system, we recommend that every effort be made to also ensure a low SWR at the antenna feed point.



- The ATU in the FT-710 is designed to match impedances within the range of 16.5 Ohms to 150 Ohms, corresponding to an SWR of 3:1 or less on the HF amateur bands (6 m amateur band: 25 Ohms to 100 Ohms, corresponding to an SWR of 2:1 or less). Accordingly, simple non-resonant whip antennas, along with random-length wires and the “G5RV” antenna (on most bands) may not be within the impedance matching range of the ATU.
- The built-in antenna tuner cannot be used with an antenna connector connected to an external antenna tuner.

• ATU Operation

1. Press the [TUNE] key momentarily to place the ATU in the transmit line (no adjustment or tuning will occur yet). While the ATU function is activated, the “TUNE” will be displayed.

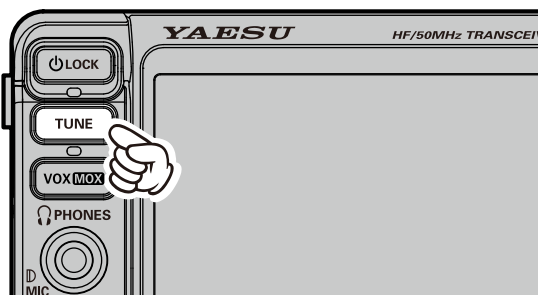

- The momentary press of the [TUNE] key will turn the tuner ON, and the microprocessor will automatically select the tuning point closest to the current operating frequency.
2. Press and hold the [TUNE] key to begin automatic tuning.
 - The transmitter will be engaged, and “TUNE” will be displayed while tuning is in progress.
 - Always listen on the operating frequency before beginning the tuning process, to be sure tuning will not interfere with others who may already be using the frequency.
 - When the optimum tuning point has been achieved, the transceiver will return to receive.
 3. To disengage the ATU from the transmit line, press the [TUNE] key momentarily.



The ATU microprocessor memories store the record of the capacitors and inductors selected to tune each 10kHz window in which tuning has occurred. This eliminates the need to re-tune every time operation returns to a frequency on which the tuning process has already been completed.

About ATU Memories

SWR (After tuning) Less than 2:1

The tuner settings are stored in the ATU memory.

SWR (After tuning) Greater than 2:1

Tuning data will not be retained in memory. If operation is returned to the same frequency, the tuning process must be repeated.

SWR (After tuning) Greater than 3:1

The “HI-SWR” icon will light up, and the tuner settings, if achieved, will not be memorized. Investigate the high SWR condition and resolve the problem before attempting further operation using this antenna.

CW Mode Operation

The impressive CW operating capabilities of the FT-710 permit operating with an Electronic Keyer Paddle, a “Straight Key”, or a computer based keying device.

1. Before starting, connect the key cable to the rear panel KEY jack.
2. Set the operating mode to CW-U.
The normal “CW” mode utilizes USB-side carrier injection.
3. Rotate the Main Tuning Dial knob to select the desired operating frequency.
4. Press the [FUNC] knob.

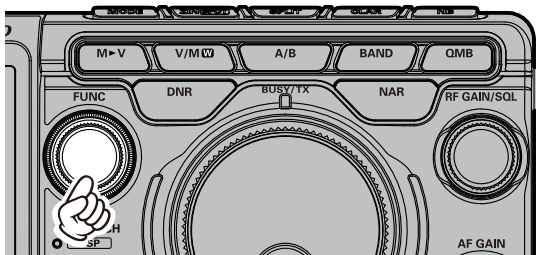

5. Touch [BK-IN] to turn ON the BK-IN function.
6. Touch [MONI LEVEL] and then turn the [FUNC] knob to adjust the volume of the monitor.
7. When using the keyer paddle, press the [FUNC] knob and then touch [KEYER] to turn ON the Electronic Keyer.
8. When the key or the keyer paddle is pressed, the transmitter will automatically be engaged.
 - Press [FUNC], then touch [CW SPEED], and rotate the [FUNC] knob to set the desired sending speed.
 - As shipped from the factory, the FT-710 CW TX/RX is configured for “Semibreak-in” operation. However, using Menu item “CW BK-IN TYPE”, this setup may be changed to full break-in (QSK) operation, wherein the switching is quick enough to hear incoming signals in the spaces between the dots and dashes of the transmission. This may prove very useful during contest and traffic handling operations.

• Adjusting the Sidetone Audio level

The CW sidetone audio level may be adjusted by press the [FUNC] knob, then touch [MONI LEVEL], and then rotating the [FUNC] knob.

• CW Delay Time Setting

During semi-break-in (not QSK) operation, the hang time of TX, after the transmitting ends may be adjusted to a comfortable value corresponding with the sending speed.

1. Press the [FUNC] knob, then touch [BK-DELAY].
2. Start sending and rotate the [FUNC] knob to adjust the hang time for comfortable operation.
3. Approximately 1 second after selection, the settings are saved and the normal operation screen returns.

CW Spotting (Zero-Beating)

“Spotting” (zeroing in on another CW station) is a handy technique to ensure the transceiver and the other station are operating precisely on the same frequency.

The Tuning Offset Indicator in the display may also be moved to adjust the receiver frequency to center on the incoming station with the CW pitch corresponding to that of the transmit signal.



Turn OFF the Tuning Offset Indicator using Menu item “CW INDICATOR”.

Setting of the Electronic Keyer

• Adjusting the Keyer Speed

Keyer speed can be adjusted by rotating the [FUNC] knob.

Press [FUNC], then touch [CW SPEED], and rotate the [FUNC] knob to set the desired sending speed (4 wpm - 60 wpm).

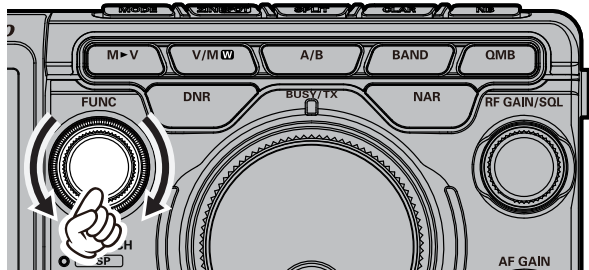

• Setting the Keyer Weight (Dot/Dash) Ratio

This Menu item may be used to adjust the dot/dash ratio for the built-in Electronic Keyer. The default weighting is 3:0 (a dash is three times longer than a dot).

1. Press the [FUNC] knob.
2. Select [CW SETTING] → [KEYER] → [CW WEIGHT].
3. Rotate the [FUNC] knob, or touch “<” or “>” on either side of the value to set the weight to the desired value. The available adjustment range is a Dot/Dash ratio of 2.5 - 4.5 (default value: 3.0).
4. Press the [FUNC] knob, or wait for about 3 seconds to save the setting.
5. Touch [BACK] several times to return to normal operation.

• Reversing the Keyer Polarity

The Keyer polarity can be reversed easily in the Menu mode without changing the keyer connections (the default setting is “NOR”). Example: for left-handed operators in a contest.



In the Keyer modes described on the chart at the right, BUG and OFF modes are not changed.

1. Press the [FUNC] knob.
2. Select [CW SETTING] → [KEYER].
3. Select [KEYER DOT/DASH].
4. Rotate the [FUNC] knob, or touch “<” or “>” on either side of the value to set the “REV”.
5. Press the [FUNC] knob, or wait for about 3 seconds to save the setting.
6. Touch [BACK] several times to return to normal operation.

• Selecting the Keyer Operating Mode

The configuration of the Electronic Keyer may be customized for the FT-710. This permits utilization of Automatic Character Spacing (ACS), if desired. This allows the use of an electronic keyer via the front jack and a computer-driven keying line via the rear panel.

1. Press the [FUNC] knob.
2. Select [CW SETTING] → [KEYER].
3. Select [KEYER TYPE].
4. Rotate the [FUNC] knob, or touch “<” or “>” on either side of the value to set the keyer to the desired operating mode, see the table below.
5. Press the [FUNC] knob, or wait for about 3 seconds to save the setting.
6. Touch [BACK] several times to return to normal operation.

OFF	The built-in Electronic Keyer is turned OFF (“straight key” mode).
BUG	Dots will be generated automatically by the keyer, but dashes must be sent manually.
ELEKEY-A	A code element (“Dot” or “Dash” side) is transmitted upon releasing both sides of the paddle.
ELEKEY-B	Releasing both sides of the paddle transmits the currently generated “Dash” side followed by “Dot” side (or reverse order).
ELEKEY-Y	Pressing both sides of the paddle transmits the currently generated “Dash” side followed by “Dot” side (or reverse order). While transmitting the “Dash” side, the first transmitted “Dot” side will not be stored.
ACS	Same as “ELEKEY” except that the spacing between characters is precisely set by the keyer to be the same length as a dash (three dots in length). <div style="display: flex; align-items: center;"> <div style="margin-right: 10px;"> <p>ACS OFF</p> <p>Morse “E” & “T”</p> </div> </div> <div style="display: flex; align-items: center;"> <div style="margin-right: 10px;"> <p>ACS ON</p> <p>Morse “E” & “T”</p> </div> </div>

Contest Memory Keyer

The CW message capability of the FT-710 may be controlled either from the Transceiver Front Panel, or with the optional FH-2 Remote Control Keypad, which plugs into the rear panel REM jack.

• Message Memory

Five CW memory channels capable of retaining 50 characters each are available (using the PARIS standard for characters and word length).

Example: CQ CQ CQ DE W6DXC K (19 characters)

--- · · · · · --- · · · · · --- · · · · · --- · · · · · --- · · · · · --- · · · · ·
C Q C Q C Q D E W 6 D X C K

• Storing a Message into Memory

1. Press the [FUNC] knob.
2. Select [CW SETTING] → [KEYER].
3. Select the CW Memory Register (“CW MEMORY 1” to “CW MEMORY 5”) into which the message is to be stored; for now, the message entry technique is being set to “Keyer Entry” for the selected CW Memory register.
4. Set the selected CW Memory Register to “MESSAGE”. To use the Keyer Paddle for message entry on all the memories, set all five Menu items to “MESSAGE”.
5. Press the [FUNC] knob, or wait for about 3 seconds to save the setting.
6. Touch [BACK] several times to return to normal operation.

• Message Memory Programming (Using your Paddle)

1. Set the operating mode to CW.
2. Press the [FUNC] knob.
3. Touch [BK-IN] to turn it “OFF”.
4. Touch [KEYER] to turn it “ON”.
The built-in Electronic Keyer is activated. When using the optional FH-2 Controller, go to step 6.
5. Touch [MESSAGE].
The “MESSAGE MEMORY” screen will be displayed.
6. Touch [MEM] on the display or press the [MEM] key on the FH-2.
A blinking “REC” will appear in the display.



If a Key [1] through [5] is not pressed within 10 seconds (see next step), the memory storage process will be cancelled.

7. Touch [1] through [5] on the display or press any of the FH-2 keys numbered [1] through [5] to select that memory storage register.
 - The “REC” will glow steadily.
 - If keying is not begun within ten seconds, the memory storage process will be cancelled.
8. Send the desired CW message using the keyer paddle.
9. Touch [MEM] on the display or press the [MEM] key on the FH-2 once more to end message recording.



Care must be exercised in sending to ensure the spaces between letters and words are accurately applied.

If the timing is off, the spacing may not be correct in the stored message. For ease in setting up the keyer memories, we recommend setting Menu item “KEYER TYPE” to “ACS” (Automatic Character Spacing) while programming the keyer memories.

• Checking the CW Memory Contents

1. Press the [FUNC] knob.
2. Touch [BK-IN] to turn it "OFF".
3. Touch [MONI LEVEL] and then turn the [FUNC] knob to adjust the volume of the monitor.
When using FH-2, go to step 6.
4. Press the [FUNC] knob.
5. Touch [MESSAGE].
The "MESSAGE MEMORY" screen will be displayed.
6. Touch [1] - [5] on the display or press the FH-2 [1] - [5] key, whichever memory was just recorded. The message will be played and heard in the sidetone monitor, but no RF energy will be transmitted.
 - The "MSG" will appear in the display.

• On-The-Air CW Message Playback

1. Press the [FUNC] knob.
2. Touch [BK-IN] to turn it "ON".
When using FH-2, go to step 4.
3. Touch [MESSAGE].
The "MESSAGE MEMORY" screen will be displayed.
4. Touch [1] - [5] on the display or press the FH-2 [1] - [5] key, to transmit the recorded CW Memory Register message. The programmed message will be transmitted on the air.
 - During a transmission, the same key may be pressed again to immediately end the transmission.

Transmitting in the Beacon Mode

In "Beacon" mode, any programmed message, (either via Paddle, or via "Text" input method) may be repeatedly transmitted. The time delay between message repeats may be set from 1 to 60 seconds, in one second steps, via Menu item "REPEAT INTERVAL".

To transmit the message:

1. Touch and hold [1] - [5] on the display or press and hold the FH-2 [1] - [5] key. Repetitive transmission of the Beacon message will begin.
2. Press the same key again to cancel the Beacon Mode.

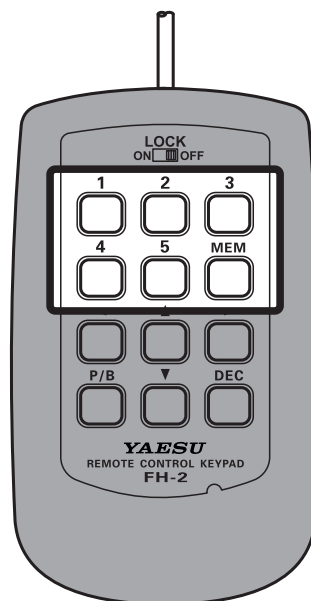

• TEXT Memory

The five channels of CW message memory (up to 50 characters each) may also be programmed using a text-entry technique.

This technique is somewhat slower than sending the message directly from the keyer paddle, but accuracy of character spacing is ensured. Be sure to enter the character “}” at the end of the text message.

Example 1: CQ CQ CQ DE W6DXC K} (20 characters)

The sequential Contest Number (“Count up”) feature is another impressive feature of the CW Memory Keyer.

Example 2: 599 10 200 # K} (15 characters)

• Text Memory Storage

1. Press the [FUNC] knob.
2. Select [CW SETTING] →[KEYER].
3. Select the CW Memory Register (“CW MEMORY 1” to “CW MEMORY 5”) into which a message is to be stored. For now, the message entry technique is being set to (Text entry) for the selected CW Memory Register.
4. If Text Message entry is to be used for all five memories, set all five CW Memory Register Menu items to “TEXT”.
5. Press the [FUNC] knob, or wait for about 3 seconds to save the setting.
6. Touch [BACK] several times to return to normal operation.

• Text Message Programming

1. Set the operating mode to CW.
When using the optional FH-2, go to step 4.
2. Press the [FUNC] knob.
3. Touch [MESSAGE].
The “MESSAGE MEMORY” screen will be displayed.
4. Touch [MEM] on the display or press the [MEM] key on the FH-2.
5. Touch [1] through [5] on the display or press any of the FH-2 keys numbered [1] through [5] to select that memory storage register.
The text input screen will appear.



The following texts are programmed to MEMORY 4 and MEMORY 5 in factory default.

MEMORY 4: DE FT-710 K}

MEMORY 5: R 5NN K}

6. Touch the character keys on the display to enter the letters, numbers, or symbols of the desired label. Use the “#” character to designate the position where the Contest Number will appear.
7. When the message is complete, add the “}” character at the end to signify the termination of the message.

Example: CQ CQ CQ DE W6DXC K}



Use the FH-2 [◀] and [▶] keys to set the cursor position and use the FH-2 [▲] and [▼] keys to choose the letter/number to be programmed into each slot of the memory.

8. When the text entry is completed, touch [ENT].



9. When all the characters (including “}”) have been programmed, touch [BACK] to exit.

• Checking the CW Memory Contents

1. Set the operating mode to CW.
2. Press the [FUNC] knob.
3. Touch [BK-IN] to turn it "OFF".
4. Touch [MONI LEVEL] and then turn the [FUNC] knob to adjust the volume of the monitor.
When using the optional FH-2, go to step 7.
5. Press the [FUNC] knob.
6. Touch [MESSAGE].
The "MESSAGE MEMORY" screen will be displayed.
7. Touch [1] - [5] on the display or press the FH-2 [1] - [5] key, whichever memory that was recorded in. The message will be played, and heard in the sidetone monitor, but no RF energy will be transmitted.

- "MSG" will appear in the display.

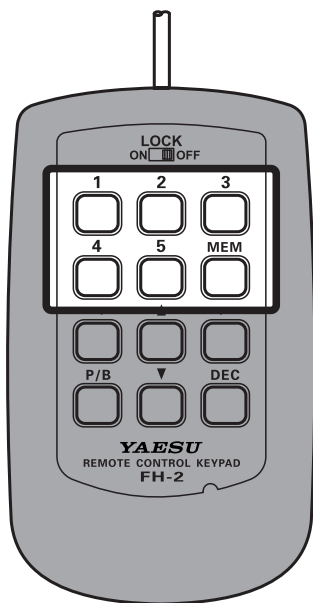

• On-The-Air CW Message Playback

1. Set the operating mode to CW.
2. Press the [FUNC] knob.
3. Touch [BK-IN] to turn it "ON".
When using FH-2, go to step 5.
4. Touch [MESSAGE].
The "MESSAGE MEMORY" screen will be displayed.
5. Touch [1] - [5] on the display or press the FH-2 [1] - [5] key, depending on the CW Memory Register message to be transmitted. The programmed message will be transmitted on the air.
 - During transmit, press the same key again, to immediately cancel the transmission.

Transmitting in the Beacon Mode

In "Beacon" mode, any programmed message, (either via Paddle, or via "Text" input method) may be repeatedly transmitted. The time delay between message repeats may be set from 1 to 60 seconds, in one second steps, via Menu item "REPEAT INTERVAL".

To transmit the message:

1. Touch and hold [1] - [5] on the display or press and hold the FH-2 [1] - [5] key. Repetitive transmission of the Beacon message will begin.
2. Press the same key again to cancel the Beacon Mode.

Contest Number

If "#" is entered in the CW message, the contest number will automatically increment (count up) each time the message is sent. See below to set the contest number.

Contest Number Programming

1. Press the [FUNC] knob.
2. Select [CW SETTING] → [KEYER] → [CONTEST NUMBER].
3. Rotate the [FUNC] knob, or touch "<" or ">" on either side of the value to set the Contest Number to the desired value.
4. Press the [FUNC] knob, or wait for about 3 seconds to save the setting.
5. Touch [BACK] several times to return to normal operation.

Decrementing the Contest Number

Use this process if the current contest number gets ahead of the actual number. For example: in case of a duplicate QSO,).

Press the FH-2 [DEC] key momentarily or touch [DECxxxx] on "MESSAGE MEMORY" screen. The current Contest Number will be reduced by one. Press of the FH-2 [DEC] key as many times as necessary to reach the desired number. If you go too far, use the "Contest Number Programming" technique described above.

FM Mode Operation

Repeater Operation

The FT-710 may be operated on 29MHz and 50MHz repeaters.

1. Set the operating mode to FM.
2. Set to the desired repeater output frequency (downlink from the repeater).
3. Press the [FUNC] knob.
4. Select [RADIO SETTING] → [MODE FM] → [RPT SHIFT].
5. Rotate the [FUNC] knob, or touch “<” or “>” on either side of the value to select the desired repeater shift direction. The selections are:

“SIMP” → “+” → “-” → “SIMP”

- To program the proper repeater shift, use Menu items “RPT SHIFT(28MHz)” and “RPT SHIFT(50MHz)”, as appropriate.
6. Rotate the [FUNC] knob to select [ENC/DEC].
 7. Rotate the [FUNC] knob, or touch “<” or “>” on either side of the value to select “ENC”.
 8. Rotate the [FUNC] knob to select [TONE FREQ].
 9. Rotate the [FUNC] knob, or touch “<” or “>” on either side of the value to select the desired CTCSS Tone to be used. A total of 50 standard CTCSS tones are provided (see the CTCSS Tone Chart).
 10. Press the [FUNC] knob, or wait for about 3 seconds to save the setting.
 11. Touch [BACK] several times to return to normal operation.

Press and hold the microphone PTT switch to begin transmitting.

Tone Squelch Operation

The “Tone Squelch” may be activated to keep the receiver silent until an incoming signal modulated with a matching CTCSS tone is received. The receiver squelch will then open in response to reception of the required tone.

1. Set the operating mode to FM.
2. Set the transceiver to the desired frequency.
3. Press the [FUNC] knob.
4. Select [RADIO SETTING] → [MODE FM] → [ENC/DEC].
5. Rotate the [FUNC] knob, or touch “<” or “>” on either side of the value to select “TSQ”.
6. Rotate the [FUNC] knob to select [TONE FREQ].
7. Rotate the [FUNC] knob, or touch “<” or “>” on either side of the value to select the desired CTCSS Tone to be used. A total of 50 standard CTCSS tones are provided (see the CTCSS Tone Chart).
8. Press the [FUNC] knob, or wait for about 3 seconds to save the setting.
9. Touch [BACK] several times to return to normal operation.

CTCSS Tone Frequency (Hz)

67.0	69.3	71.9	74.4	77.0	79.7	82.5	85.4	88.5	91.5	94.8	97.4
100.0	103.5	107.2	110.9	114.8	118.8	123.0	127.3	131.8	136.5	141.3	146.2
151.4	156.7	159.8	162.2	165.5	167.9	171.3	173.8	177.3	179.9	183.5	186.2
189.9	192.8	196.6	199.5	203.5	206.5	210.7	218.1	225.7	229.1	233.6	241.8
250.3	254.1	-	-	-	-	-	-	-	-	-	-

DATA (FT8 / RTTY / PSK) Operation

The transceiver and a PC may be connected with a commercially available USB cable (A-B) to operate data communications using commercially available software and freeware.

Before connecting a RTTY communications TU (Terminal unit) or DATA Communications Device to the transceiver, also refer to the instruction manual of the connected device.

Connecting to a Personal Computer

• Connecting with a USB cable



To connect to a PC using a USB cable, a Virtual COM port driver must be installed on the PC. Visit the Yaesu website <http://www.yaesu.com/> to download the Virtual COM port driver and Installation Manual.

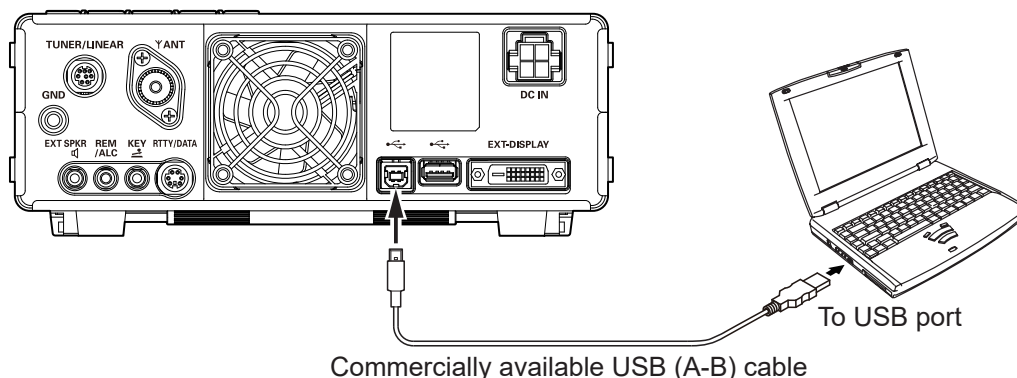

• Connecting to a DATA communications device

Connect the RTTY communications TU (Terminal Unit) or Data Communications Device to the rear panel RTTY/DATA terminal.

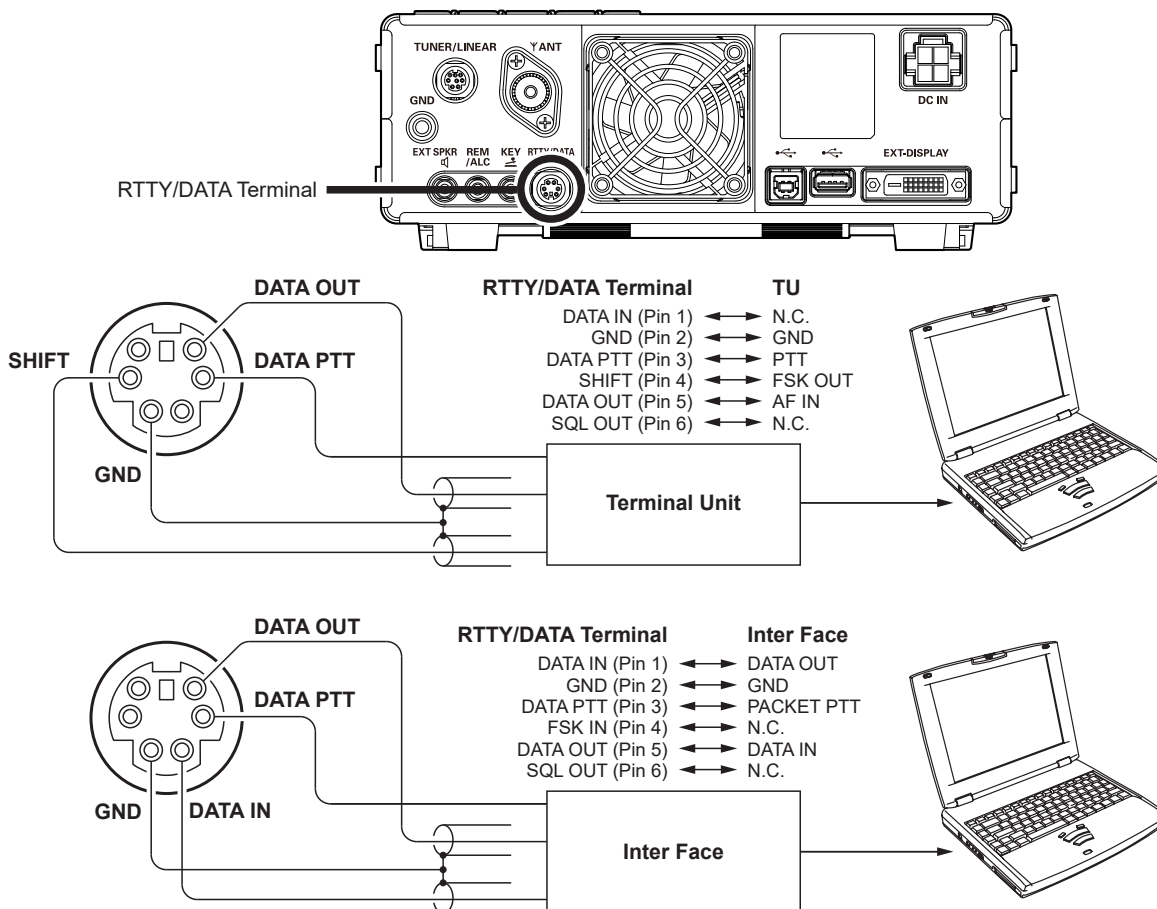

When a signal is input, it can be automatically sent using Menu item "VOX SELECT" (page 95).

FT8 operation

The multiple settings required for FT8 operation may be set with one touch of [PRESET]. In addition, the FT8 settings can be returned to the prior settings with one touch.

1. Touch the operation mode area, or press the [MODE] key.

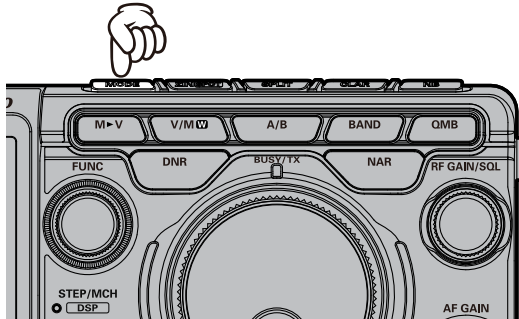

2. The operation MODE selection screen appears on the display, then touch [PRESET], or rotate the [FUNC] knob to select [PRESET]

then press the [FUNC] knob.

Touch [PRESET] or select [PRESET] via the [FUNC] knob, the settings will be confirmed and then the operating screen will return.

3. Touch [PRESET] again, the [PRESET] settings are canceled and the original settings are restored.

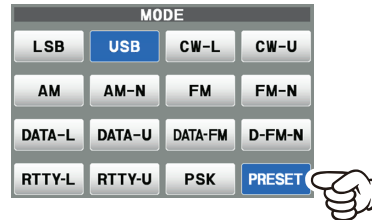

The color of the [PRESET] shows the current state.

Blue: Enable the [PRESET] settings
Gray: Disable the [PRESET] settings

• Change the [PRESET] setting

Five channels of the 17 listed in the table below are registered in [PRESET]. These settings may be changed as needed.

Function	Available Settings (Default: Bold)
CAT-1 RATE	4800bps / 9600bps / 19200bps / 38400bps / 115200bps
CAT-1 TIME OUT TIMER	10 msec / 100 msec / 1000msec / 3000msec
CAT-1 CAT-3 STOP BIT	1bit / 2bit
AGC FAST DELAY	20 msec - 160 msec - 4000msec (20msec/step)
AGC MID DELAY	20 msec - 500 msec - 4000msec (20msec/step)
AGC SLOW DELAY	20 msec - 1500 msec - 4000msec (20msec/step)
LCUT FREQ	OFF / 100Hz - 1000Hz (50Hz/step)

Function	Available Settings (Default: Bold)
LCUT SLOPE	6dB/oct / 18dB/oct
HCUT FREQ	OFF / 700Hz - 3200Hz - 4000Hz (50Hz/step)
HCUT SLOPE	6dB/oct / 18dB/oct
USB OUT LEVEL	0 - 50 - 100
REAR OUT LEVEL	0 - 50 - 100
TX BPF SEL	50-3050Hz / 100-2900Hz / 200-2800Hz / 300-2700Hz / 400-2600Hz
MOD SOURCE	MIC / USB / REAR / AUTO
USB MOD GAIN	0 - 50 - 100
REAR MOD GAIN	0 - 50 - 100
RPTT SELECT	OFF / RTS / DTR / DAKY

1. Touch and hold [PRESET], the operation mode selection screen appears on the display.
2. Touch the PRESET 1 to 5 settings to be changed.
3. Touch the desired item, or rotate the [FUNC] knob to select the desired item, then press the [FUNC] knob.
4. Rotate the [FUNC] knob, or touch "<" or ">" on either side of the value setting that is to be changed.
5. Press the [FUNC] knob, or wait for about 3 seconds to save the setting.
6. Touch [BACK] twice to return to the operation MODE selection screen. After about 5 seconds, the operation screen will return.

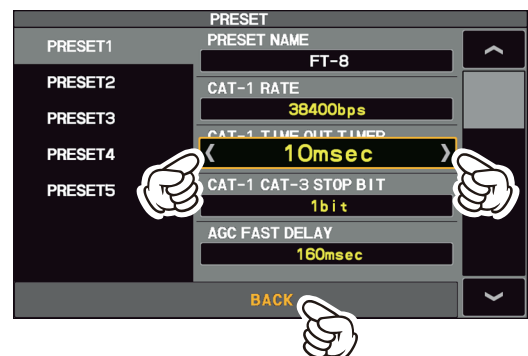
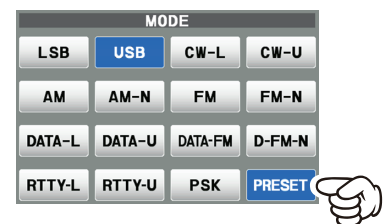

RTTY Operation

- Before operating with RTTY, set the Menu items in the chart to the below.

Setting Menu	Available Values (Bold is the default)	
RADIO SETTING → MODE RTTY → POLARITY TX	NOR	The shift direction of the RTTY transmit space frequency will be lower than the mark frequency.
	REV	The shift direction of the RTTY transmit mark frequency will be lower than the space frequency.
RADIO SETTING → MODE RTTY → RPTT SELECT	DAKY	Controls the RTTY transmit signal from the RTTY/DATA jack (pin 4) on the rear panel.
	RTS/DTR	Controls the RTTY transmit signal from the USB virtual COM/RTS or DTR ports.
RADIO SETTING → MODE RTTY → MARK FREQUENCY	1275Hz 2125Hz	Normally use at 2125 Hz.
RADIO SETTING → MODE RTTY → SHIFT FREQUENCY	170Hz 200Hz 425Hz 850Hz	Normally use at 170 Hz.

- Set the operating mode to RTTY-L.



Generally, amateur band stations operate RTTY in LSB.

Align the peak of the received signal with the mark frequency and shift frequency marker of the TFT screen.

PSK Operation

- For PSK operation, set the Menu items as indicated in the below chart.

Setting Menu	Available Values (Bold is the default)	
RADIO SETTING → MODE PSK/DATA → MODE SOURCE	MIC	Audio is input from the MIC jack on the front panel.
	USB	Audio/Data is input from the USB jack on the rear panel.
	REAR	Audio/Data is input from the RTTY/DATA jack on the rear panel.
	AUTO	Modulation is automatically selected according to the transmission method. PTT: The MIC jack on the front panel. MOX: The MIC jack on the front panel. CAT: The USB jack on the rear panel. DAKY: The RTTY/DATA jack on the rear panel. RTS: The USB jack on the rear panel. DTR: The USB jack on the rear panel. VOX: Terminal set with "VOX SELECT".
RADIO SETTING → MODE PSK/DATA → RPTT SELECT	DAKY	Controls the DATA transmit signal from the RTTY/DATA jack (pin 4) on the rear panel.
	RTS/DTR	Controls the DATA transmit signal from the USB virtual COM/RTS or DTR ports.

- Set the operating mode to PSK.



Set the operation mode of the data communication software application on the PC to "DATA-U".

Align the peak of the received signal with the mark frequency and shift frequency marker of the TFT screen.

Memory Operation

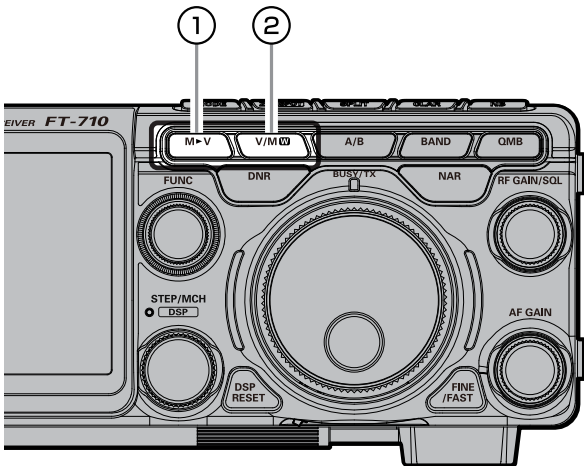

① M▶V

Data saved in a memory channel can be transferred to the VFO.

• Moving Memory Data to the VFO register

The contents of the currently selected Memory Channel may be transferred into the VFO register:

1. Press and hold the [V/M/W] key while operating in either VFO mode, or memory channel mode.
The memory channel list will be displayed.
2. From the channel list, touch the memory channel to select it and transfer it to the VFO. Alternately, the memory channel may be selected by rotating the [STEP•MCH/DSP] knob.
3. Press the [M▶V] key, the data in the selected memory channel will now be transferred to the upper VFO, press and hold the [M▶V] key, the data in the selected memory channel will now be transferred to the lower VFO.

• Transfer last used memory to VFO

When in VFO mode, the last used VFO memory may be copied to VFO-A or VFO-B.

Press the [M▶V] key → Copy to the upper VFO

Press and hold [M▶V] key → Copy to the lower VFO

The memory last used by VFO-A is copied to VFO-A, and the memory last used by VFO-B is copied to VFO-B.

② V/M/W

This key toggles frequency control between VFO and the memory system.



The contents of the memory channels can be recalled and used later.

• Memory Storage

1. Set the frequency, mode, and status, as desired.
2. Press and hold the [V/M/W] key.
The memory channel list will be displayed.
3. From the channel list, touch and select the desired memory channel
Alternately, the memory channel may be selected by rotating the [STEP•MCH/DSP] knob.

MEMORY CH LIST				NAME	MODE
M-01	7.050.000	LSB			
M-02	14.195.000	USB		SCAN MEMORY	DISPLAY TYPE
M-03	21.150.000	USB			RESTORE
M-04	--.---.---	-----			BACK

4. Press and hold the [V/M/W] key to store the frequency and other data into the selected memory channel.
 - This method may also be used to overwrite the contents previously stored to a memory channel.
5. Touch [BACK], the memory is stored and the screen returns to normal.



The information saved in the memory may be lost due to incorrect operation, static electricity or electrical noise. Data may also be lost due to component failures and repairs. Make sure to write down the information registered in the memories on a piece of paper or by using a SD card.

• Recall a Memory Channel other than the last used VFO frequency

Rotate the [STEP•MCH/[DSP]] knob to select a memory

1. Press the [V/MW] key.
2. Rotate the [STEP•MCH/[DSP]] knob, to select the desired memory channel.

Touch the display to select a memory

1. Press and hold the [V/MW] key. The memory channel list will be displayed.

MEMORY CH LIST					
M-01	7.050.000	LSB		NAME	MODE
M-02	14.195.000	USB		SCAN MEMORY	DISPLAY TYPE
M-03	21.150.000	USB			ERASE
M-04	--. --. --.	-----	-----		BACK

2. From the channel list, touch and select the desired memory channel. Alternately, the memory channel may be selected by rotating the [STEP•MCH/[DSP]] knob.
3. Press the [STEP•MCH/[DSP]] knob.
4. To exit from memory mode and return to the VFO mode, press the [V/MW] key.



If a memory group is set, the channels stored in the selected memory group may be recalled.

• Memory Tune Operation

You may freely tune off from any memory channel in a “Memory Tune” mode, this is similar to VFO operation. So long as you do not over-write the contents of the current memory, Memory Tune operation will not alter the contents of the memory channel.

- The “*MT*” notation will appear instead of the “M-*nn*”.

Press the [V/MW] key to return to the originally memorized frequency of the current memory channel.

• Memory Groups

Memory channels may be listed into as many as six convenient groups, for easy identification and selection. For example: groups for AM BC stations, Short-wave broadcast stations, Contest frequencies, Repeater frequencies, PMS limits, or any other desired grouping may be created.

Each memory group may hold up to 20 memory channels (except Memory Group 01 which is limited to 19 memory channels). When memory channels are grouped, the channel numbers change to correspond to the chart below:

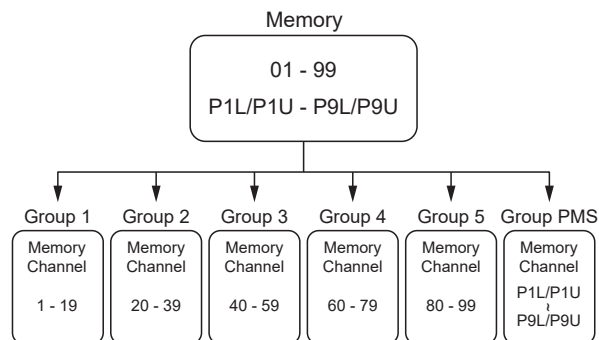

1. Press the [FUNC] knob.
2. Select [OPERATION SETTING]→[GENERAL]→[MEM GROUP].
3. Rotate the [FUNC] knob, or touch “<” or “>” on either side of the value to select “ON”.
4. Press the [FUNC] knob, or wait for about 3 seconds to save the setting.
5. Touch [BACK] several times to return to normal operation.
6. To cancel Memory Group operation, repeat steps 1 through 5 above, choosing “OFF” in step 3.

Choosing the Desired Memory Group

If desired, just the memories listed within a particular Memory Group, may be recalled.



Before performing the operation, set the “MEM GROUP” menu to “ON” (Refer to “Memory Groups” setting in the above instruction).

1. Press the [V/MW] key, if necessary, to enter the “Memory” mode.
2. Press the [FUNC] knob.
3. Touch [M-GROUP].
4. Rotate the [FUNC] knob to select the desired Memory Group.
5. Rotate the [STEP•MCH/[DSP]] knob to select the desired Memory Channel within the Selected Memory Group.

• Erasing Memory Channel Data

The contents written to the memory channel may be erased.

1. Press and hold the [V/M **W**] key.
The memory channel list will be displayed.
2. From the channel list, touch and select the memory channel to be erased.
Alternately, the memory channel may be selected by rotating the [STEP•MCH/ **DSP**] knob.
3. Touch [ERASE] to clear the contents of the selected memory channel.

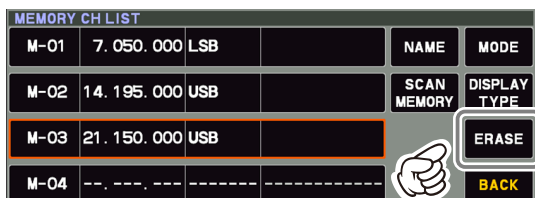

4. Touch [BACK] to erase the contents of the selected memory channel.

i If you make a mistake and wish to restore a memories contents, touch [RESTORE].

! Memory channels “M-01” (and “5-01” through “5-10”: U.S. version, “5-01” through “5-07”: U.K. version) cannot be erased.

• Check Memory Channel Status

Before programming a memory channel, the current contents of that channel may be verified without the danger of over-writing the channel.

1. Press and hold the [V/M **W**] key.
The memory channel list will be displayed.

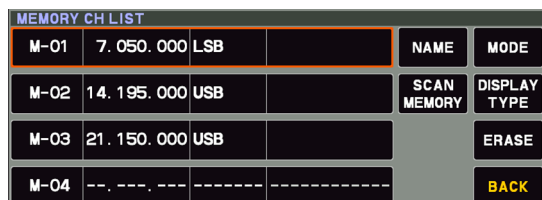

2. From the channel list, touch and select the memory channel and check, or change the operation mode.
Alternately, the memory channel may be selected by rotating the [STEP•MCH/ **DSP**] knob.

• Press the [STEP•MCH/ **DSP**] knob to enter memory mode on the selected channel.

3. To change the operation mode, touch [MODE], rotate the [STEP•MCH/ **DSP**] knob to select the mode then press the [STEP•MCH/ **DSP**] knob.

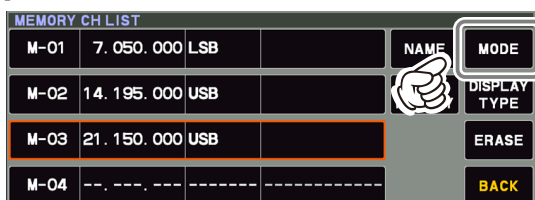

4. Touch [BACK] to return to the previous screen.

• Labeling Memories

Alphanumeric labels (“Tags”) may be appended to memory channels, to aid in recollection of the channel’s use (such as a club name, a location etc.).

1. Press and hold the [V/M **W**] key.
The memory channel list is displayed.
2. From the channel list, touch and select the desired memory channel.
Alternately, the memory channel may be selected by rotating the [STEP•MCH/ **DSP**] knob.
3. Touch [NAME] area on the screen.
The character input screen will be displayed.
4. Touch a character key on the display to enter the letters, numbers, or symbols of the desired label.
Up to 12 characters may be used in the creation of a label.



5. Touch [ENT] .
To add a label to another memory, repeat steps 2 to 5 above.
6. Touch [BACK] to save the new settings and return to normal operation.

• Displaying the Memory Tag

The “Frequency display” or “Alpha tag display” format may be selected.

1. Press and hold the [V/M **W**] key.
The memory channel list will be displayed.
2. From the channel list, touch and select the desired memory channel.
Alternately, the memory channel may be selected by rotating the [STEP•MCH/ **DSP**] knob.
3. Touch [DISPLAY TYPE] area.

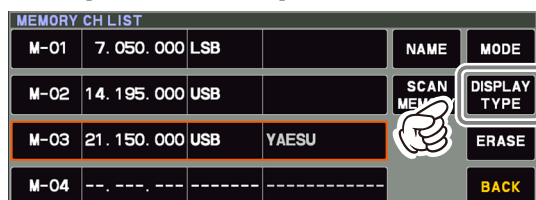

4. Rotate the [STEP•MCH/ **DSP**] knob to select the desired display type.

FREQ	Frequency
NAME	Memory Tag

5. Touch [BACK] to save the new setting and return to normal operation.

• Scan Skip Setting

The “Frequency display” or “Name display” format may be selected.

1. Press and hold the [V/M **W**] key.
The memory channel list will be displayed.
2. From the channel list, touch and select the Memory Channel to be skipped during scanning.
Alternately, the memory channel may be selected by rotating the [STEP•MCH/[DSP]] knob.
3. Touch [SCAN MEMORY] area.

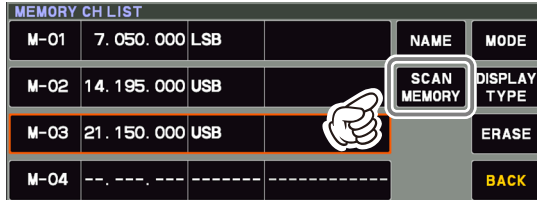

4. Rotate the [STEP•MCH/[DSP]] knob to select “SKIP”, then press the [STEP•MCH/[DSP]] knob.
 - “X” lights up for channels for which “SKIP” is set.

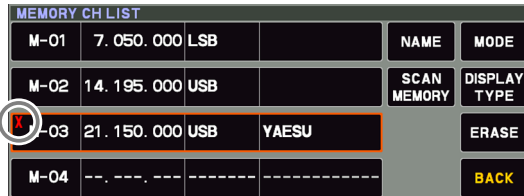

5. Touch [BACK] to save the new setting and return to normal operation.



To re-institute a channel into the scanning loop, select “SCAN” in step 4 above.

• 60-Meter (5 MHz) Band

(U.S. and U.K. Version only)

Memory channels (U.S. version: “5-01” through “5-15”, U.K. version: “5-01” through “5-07”) are pre-programmed, at the factory, with the permitted frequencies in the 5 MHz band, and the USB, CW-U or DATA-U (U.S. version only) mode is automatically selected on these channels.

These channels appear after the “last” PMS channel (“M-P9U”).

Channel Number	Frequency	
	U.S. Version	U.K. Version
5-01	5.332.000 MHz (USB)	5.260.000 MHz (USB)
5-02	5.348.000 MHz (USB)	5.280.000 MHz (USB)
5-03	5.358.500 MHz (USB)	5.290.500 MHz (USB)
5-04	5.373.000 MHz (USB)	5.368.000 MHz (USB)
5-05	5.405.000 MHz (USB)	5.373.000 MHz (USB)
5-06	5.332.000 MHz (CW-U)	5.400.000 MHz (USB)
5-07	5.348.000 MHz (CW-U)	5.405.000 MHz (USB)
5-08	5.358.500 MHz (CW-U)	-
5-09	5.373.000 MHz (CW-U)	-
5-10	5.405.000 MHz (CW-U)	-
5-11	5.332.000 MHz (DATA-U)	-
5-12	5.348.000 MHz (DATA-U)	-
5-13	5.358.500 MHz (DATA-U)	-
5-14	5.373.000 MHz (DATA-U)	-
5-15	5.405.000 MHz (DATA-U)	-

VFO and Memory Scanning

Either the VFO or the memory channels of the FT-710 may be scanned, and the receiver will halt scanning on any frequency with a signal strong enough to open the receiver squelch.

In the SSB/CW and SSB-based Data modes, the decimal points in the frequency display area will blink and the scanner will slow down (but does not stop).

VFO/Memory Scan

1. Set the frequency or Memory channel at which scanning is to begin.
2. Rotate the [RF GAIN/SQL] knob so that the background noise is just silenced (page 37).

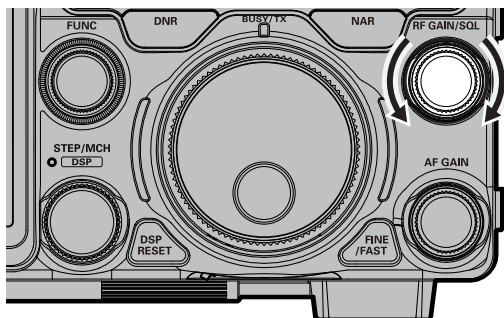

3. Pressing and holding the UP or DWN key on the microphone will start the scanning.
 - If the scanner halts on an incoming signal, the decimal point between the “MHz” and “kHz” digits of the frequency display will blink.
 - The operation when a signal is received during scanning varies depending on the mode type.

Other than LSB, USB CW-L, CW-U	Scanning will pause.
LSB, USB CW-L, CW-U	Scanning speed will be slower, but scanning will not be paused.

- If the scan has paused on a signal, pressing the microphone UP or DWN button will cause scanning to resume instantly.
- If the Main Tuning Dial knob is rotated while scanning is in progress, the VFO scanning or memory channel scanning will continue up or down in accordance with the direction of the Dial Knob rotation. (In other words, if the dial is rotated to the left when scanning toward a higher frequency or memory channel number, the direction of the scan will reverse.)

To cancel scanning, press the PTT switch, or press any key on the front panel of the transceiver.

If the microphone PTT button is pressed during scanning, the scanner will halt at once. However, pressing the PTT button while scanning will not cause transmission.

- If you have no interest in scanning, and wish to prohibit the microphone UP/DWN buttons from initiating scanning, you may disable scanning control from the microphone using Menu item [OPERATION SETTING] → [GENERAL] → [MIC SCAN].
- During Memory Group operation, only the channels within the current Memory Group will be scanned.
- The manner in which the scanner resumes after it has paused on a signal may be selected by using Menu item [OPERATION SETTING] → [GENERAL] → [MIC SCAN RESUME].

The default “TIME” (5 sec) setting will cause the scanner to resume scanning after five seconds; however the scan setting may be changed to resume only after the received signal has dropped out.

Programmable Memory Scan (PMS)

To limit scanning (and manual tuning) to a particular frequency range, the Programmable Memory Scanning (PMS) feature utilizes nine special-purpose memory pairs (“M-P1L/M-P1U through M-P9L/ M-P9U). The PMS feature is especially useful in helping to observe any operating sub-band limits which apply to your Amateur license class.

First: store the Lower and Upper tuning/scanning limit frequencies into the memory pair “M-P1L” and “M-P1U”, respectively (or any other “L/U” pair of special PMS memories).

1. Recall the memory channel “M-P1L”.
2. Rotate the [RF GAIN/SQL] knob so that the background noise is just silenced (page 37).

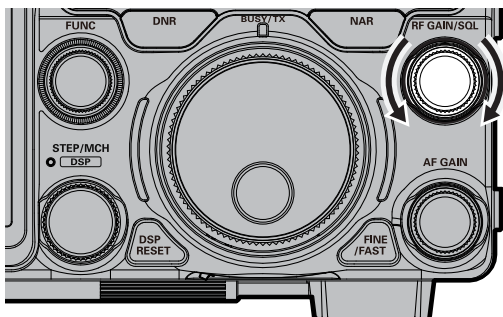

3. Turn the Main Dial knob slightly (to activate memory tuning). The Memory Channel “M-P1L” will be replaced by “PMS”.
4. Pressing and holding the UP or DWN key on the microphone to start PMS.
 - Scanning is only between frequencies stored in M-P1L and M-P1U.
 - The operation when a signal is received during scanning varies depending on the mode type.

Other than LSB, USB CW-L, CW-U	Scanning will pause.
LSB, USB CW-L, CW-U	Scanning speed will be slower, but scanning will not be paused.

- If the scan has paused on a signal, pressing the microphone UP or DWN button will cause scanning to resume instantly.
- If the Main Tuning Dial knob is rotated while scanning is in progress, the scanning will continue up or down in frequency according to the direction of the Dial Knob rotation. (In other words, if the dial is rotated to the left when scanning toward a higher frequency or memory channel number, the direction of the scan will reverse.)

To cancel scanning, press the PTT switch, or press any key on the front panel of the transceiver. If the microphone PTT button is pressed during scanning, the scanner will halt at once. However, pressing the PTT button while scanning will not cause transmission.

- If you have no interest in scanning, and wish to prohibit the microphone UP/DWN buttons from initiating scanning, you may disable scanning control from the microphone using Menu item [OPERATION SETTING] → [GENERAL] → [MIC SCAN].
- The manner in which the scanner resumes after it has paused on a signal may be selected by using Menu item [OPERATION SETTING] → [GENERAL] → [MIC SCAN RESUME].

The default “TIME” (5 sec) setting will cause the scanner to resume scanning after five seconds; however the scan setting may be changed to resume only after the received signal has dropped out.

Other Functions

Band Stack Operation

The FT-710 employs a triple band-stack VFO selection technique that permits storing up to three favorite frequencies and modes onto each band VFO register.

A typical setup, for the 14MHz band, might be arranged like this:

1. Program 14.0250 MHz, CW-U Mode, then press the [BAND] key then touch [14].
2. Program 14.0800 MHz, RTTY-L Mode, then press the [BAND] key then touch [14].
3. Program 14.1950 MHz, USB Mode, then press the [BAND] key then touch [14].

With this configuration, successive momentary presses of the [BAND] key and then touching [14] will step sequentially through the three Band Stack VFOs.

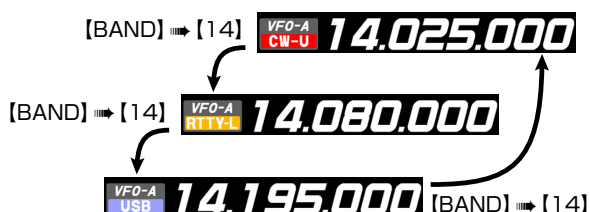

TOT (Time Out Timer)

The “Time-Out Timer” (TOT) shuts the transmitter OFF after continuously transmitting for the programmed time.

1. Press the [FUNC] knob.
2. Select [OPERATION SETTING] → [GENERAL] → [TX TIME OUT TIMER].
3. Rotate the [FUNC] knob, or touch “<” or “>” on either side of the value to select the TOT countdown time (1 -30 min or OFF).
4. Press the [FUNC] knob, or wait for about 3 seconds to save the setting.
5. Touch [BACK] several times to return to normal operation.

i The beep sounds at about 10 seconds before returning to receive mode automatically.

Operation on Alaska

Emergency Frequency: 5167.5kHz (U.S. Version Only)

Section 97.401(d) of the regulations governing amateur radio in the United States permit emergency Amateur communications on the spot frequency of 5167.5 kHz by stations in (or within 92.6 km of) the state of Alaska. This frequency is only to be used when the immediate safety of human life and/or property are threatened, and is never to be used for routine communications.

The FT-710 is capable of transmitting and receiving on 5167.5 kHz under such emergency conditions. Use the Setting Menu to activate the Alaska Emergency Frequency feature:

1. Press the [FUNC] knob.
2. Select [OPERATION SETTING]→[TX GENERAL]→[EMERGENCY FREQ TX].
3. Rotate the [FUNC] knob, or touch “<” or “>” on either side of the value to select “ON”.
4. Press the [FUNC] knob, or wait for about 3 seconds to save the setting.
5. Touch [BACK] several times to return to normal operation.
Emergency communication on this spot frequency is now possible.
6. Press the [V/M **W**] key, as necessary, to enter the Memory mode.
7. Rotate the [STEP•MCH/[DSP]] knob to select the emergency channel (“EMG”), which is found between channels “5-10” and “M-01”.

Screen capture

The display on the TFT screen may be saved on the SD card.

! When performing screen capture, a commercially available SD card is necessary.

1. Insert the SD card into the SD card slot.

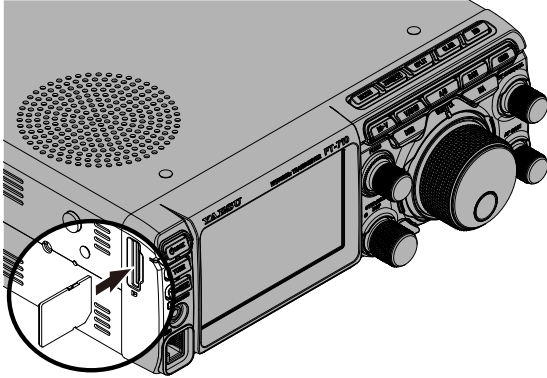

2. Display the screen that is to be saved.
3. Hold down the [MODE] key until "SCREEN SHOT" appears on the screen.
Screen data is saved to the SD card.

Data saved on the SD card can be displayed on a personal computer or similar viewer.

data form	bmp (Bitmap format)
Image size	800×480
File Name	yyyymmdd_hhmmss.bmp The captured date and time will be the file name. y (year), m (month), d (day), h (hour), m (minute), s (second)
Data storage location	"Capture" folder Folder structure in SD card FT-710 ├── Capture ├── MemList ├── Menu ├── Message └── PlayList

Using the SD Card

The following operations can be completed with the use of an SD card in the transceiver:

- Record/Play of received audio
- Voice memory (voice recording for transmission)
- Saving the Memory Channel information
- Saving the Set-up Mode settings
- Transceiver firmware update
- Save a screen capture of the TFT display

• SD Cards that can be used

YAESU has tested with the 2GB SD card, and 4GB, 8GB, 16GB and 32GB SDHC cards, most can be used in this radio.

Please format (initialize) the SD card used for the first time on this unit with this transceiver.

- The SD or SDHC cards are not provided with the product.
- Not all SD and SDHC cards sold commercially are guaranteed to work with this product.

- Do not touch the contacts of the SD card with your hands.
- SD cards formatted on other devices may not properly save information when used with this transceiver. Format SD cards again with this transceiver when using memory cards formatted with another device.

- Do not remove the SD card or turn the transceiver OFF, while saving data to the SD card is in progress.
- When a single SD card is used for a long period of time, writing and deletion of data may become disabled. Use a new SD card when data can no longer be written or erased.
- Note that Yaesu shall not be liable for any damages suffered as a result of data loss or corruption in use of the SD card.

• Installing the SD card

1. Turn OFF the transceiver.
2. Insert the SD card into the SD card slot, with the contact face on the rear, until a click sound is heard.

i To prevent the SD card from popping out, insert and remove the SD card firmly.

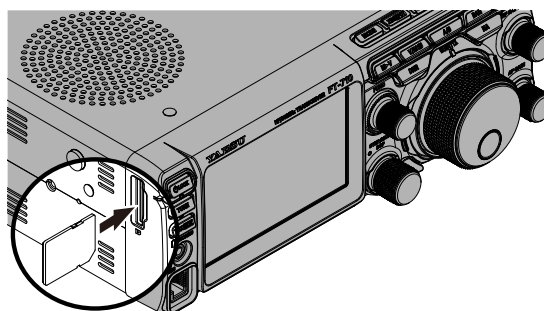

• Removing the SD card

1. Turn OFF the transceiver.
2. Push in on the SD card.
A click sound will be heard and the SD card will be pushed outward.

• Formatting a SD card

When using a new SD card, format it according to the following procedure.

! Formatting a microSD card erases all data saved on it. Before formatting the microSD card, be sure to check the data previously saved on it.

1. Press the [FUNC] knob.
2. Select [EXTENSION SETTING] → [SD CARD].
3. Touch "DONE" on the "FORMAT" item.
The format confirmation screen will be displayed.
4. Touch "OK", the SD card will be initialized.
Touch "CANCEL" to cancel the initialization.
5. "FORMAT COMPLETED" will be displayed when initialization is completed.
6. Touch the screen to end formatting.
7. Touch [BACK] several times to return to normal operation.

Adjusting the Date and Clock

If the time stamp of the saved file is not correct, adjust the date and time by the following operation.

Adjusting the Date

1. Press the [FUNC] knob → Select [EXTENSION SETTING] → [DATE&TIME].
2. Select the item "DAY", "MONTH" or "YEAR".
3. Rotate the [FUNC] knob, or touch "<" or ">" on either side of the value to select the "day", "month" and "year", then press the [FUNC] knob.
4. Press the [FUNC] knob, or wait for about 3 seconds to save the setting.
5. Touch [BACK] several times to return to normal operation.

Adjusting the Clock

1. Press the [FUNC] knob → Select [EXTENSION SETTING] → [DATE&TIME].
2. Select the item "HOUR" or "MINUTE".
3. Rotate the [FUNC] knob, or touch "<" or ">" on either side of the value to select the "hour" and "minute", then press the [FUNC] knob.
4. Press the [FUNC] knob, or wait for about 3 seconds to save the setting.
5. Touch [BACK] several times to return to normal operation.

• Saving Memory data and Setting Menu data

The Memory Channel data, and the Setting Menu data can be saved to the SD Card:

1. Press the [FUNC] knob.
2. Select [EXTENSION SETTING] → [SD CARD].
3. Touch "DONE" for the data item to be saved.

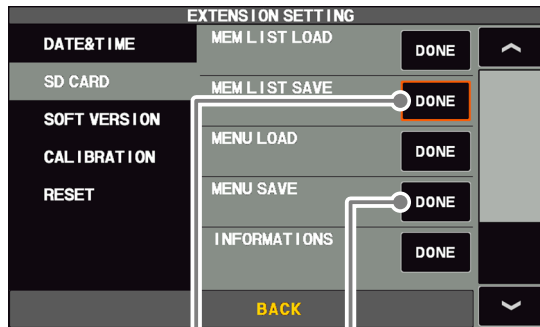

Saving memory data

Save setting menu data

4. To save the file with a new name, touch "NEW".



To overwrite previously saved data, touch the file name, and touch "OK" when the overwrite confirmation screen appears.

Touch "CANCEL" to cancel overwrite save.



When saving with a new file name

5. Enter the file name (maximum 15 characters) on the file name input screen. If the file name is not to be changed, proceed to step 6 as it is.



6. Touch "ENT" to start saving data, or touch "BACK" to cancel the name input.
7. "FILE SAVED" is displayed when data saving is completed.
8. Touch the screen to end saving data.
9. Touch [BACK] several times to return to normal operation.

• Reading Memory and Set Menu data

The Memory and Setting Menu data saved on the SD card may be read to the Transceiver.

1. Press the [FUNC] knob.
2. Select [EXTENSION SETTING] → [SD CARD].
3. Touch “DONE” of the data item to be read.

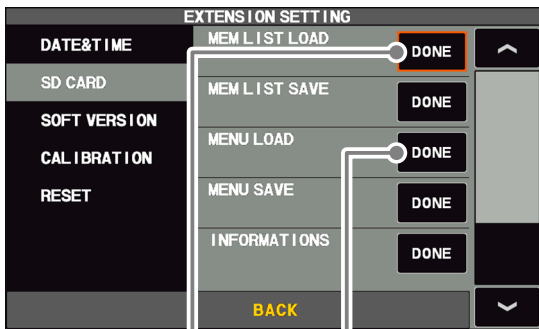

Reading memory data

Loading setting menu data

4. Touch the file name to be loaded.
Touch “BACK” to cancel reading data.

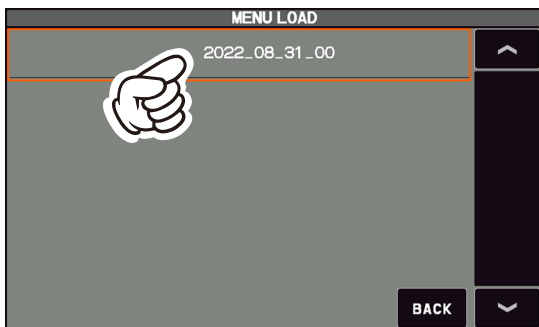

5. When the overwrite confirmation screen appears, touch “OK”.
6. “FILE LOADED” is displayed when the data reading is completed.
7. Touch the TFT screen to finish loading the data.
8. Once the power is turned OFF, the power is turned ON automatically afterwards.



With some OEM SD cards, the screen may not be displayed, even when the power is turned ON. If the screen does not appear, remove the SD card and the screen will appear.

With this, the Reading of data is completed.

• Display the SD Card Information

The memory free space of the SD card may be checked:

1. Press the [FUNC] knob.
2. Select [EXTENSION SETTING] → [SD CARD].
3. Touch “DONE” of the “INFORMATIONS” item.
The capacity and free space of the SD card are displayed.

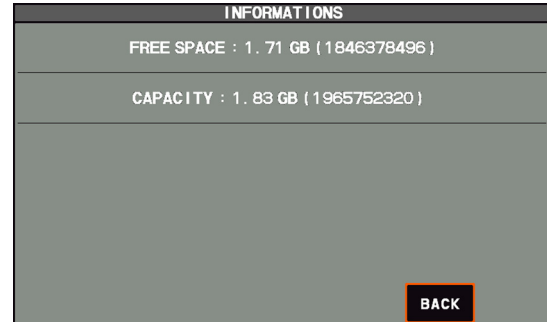

4. Touch “BACK” to return to the Setting Menu screen.
5. Touch [BACK] several times to return to normal operation.

Setting Menu

The Menu system of the FT-710 provides extensive customization capability. The transceiver functions can be tailored for the most demanding operators. The Setting Menus are grouped into five specific utilization categories.

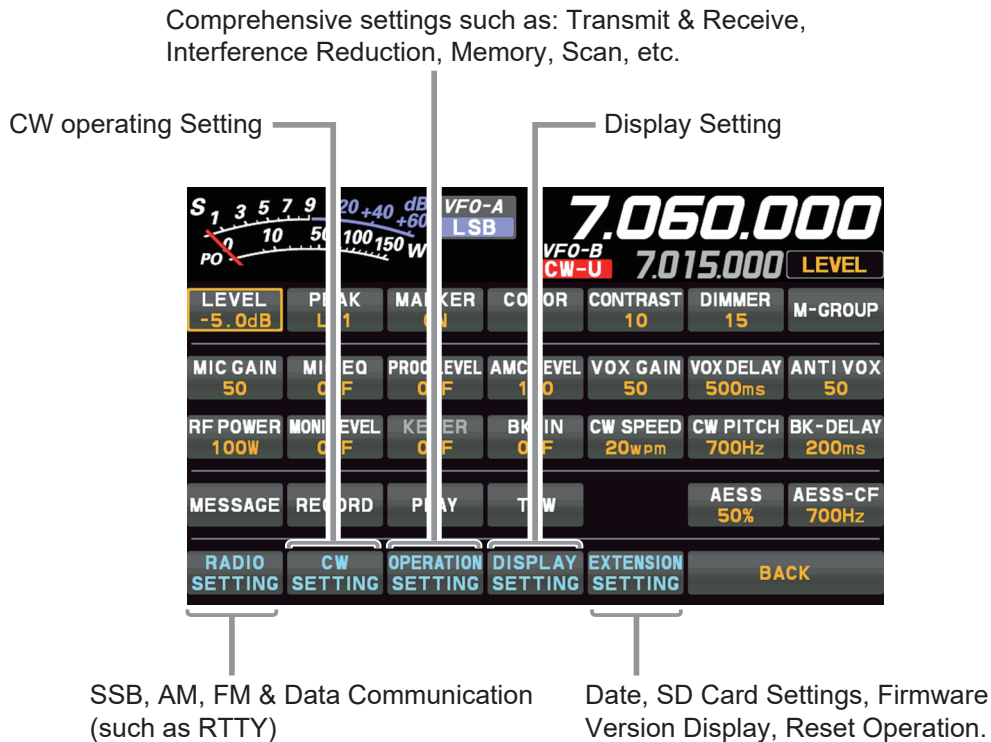

Using the Menu

1. Press the [FUNC] knob.
2. Touch the category item that is to be set (see above).
3. Touch the desired item, or rotate the [FUNC] knob to select the desired item, then press the [FUNC] knob.
4. Rotate the [FUNC] knob to select the desired item, then touch the item, or rotate the [FUNC] knob to select the desired item, then press the [FUNC] knob.
5. Rotate the [FUNC] knob, or touch "<" or ">" on either side of the value setting that is to be changed.
6. Press the [FUNC] knob, or wait for about 3 seconds to save the setting.
7. Touch [BACK] several times to return to normal operation.

Reset the Setting Menu

Use this procedure to restore the Menu settings to their factory defaults, without affecting the Programmed Frequency Memories.

1. Press the [FUNC] knob.
2. Select [EXTENSION SETTING] → [RESET] .
3. Touch "DONE" of the "MENU CLEAR" item.
The reset confirmation screen will be displayed.
4. Touch "OK" or press the [FUNC] knob to reset.
(Touch "CANCEL" to cancel the reset)
5. Once the power is turned OFF, it will turn ON automatically afterwards.
Setting Menu reset is complete.

Menu Function		Available Settings (Default: Bold)
RADIO SETTING		
MODE SSB	AF TREBLE GAIN	-20 - 0 - 10
	AF MIDDLE TONE GAIN	-20 - 0 - 10
	AF BASS GAIN	-20 - 0 - 10
	AGC FAST DELAY	20 - 300 - 4000 (20msec/step)
	AGC MID DELAY	20 - 1000 - 4000 (20msec/step)
	AGC SLOW DELAY	20 - 3000 - 4000 (20msec/step)
	LCUT FREQ	OFF / 100 - 1000 (50Hz/step)
	LCUT SLOPE	6dB/oct / 18dB/oct
	HCUT FREQ	700 - 3000 - 4000 (50Hz/step) / OFF
	HCUT SLOPE	6dB/oct / 18dB/oct
	USB OUT LEVEL	0 - 50 - 100
	REAR OUT LEVEL	0 - 50 - 100
	TX BPF SEL	50-3050 / 100-2900 / 200-2800 / 300-2700 / 400-2600
	MOD SOURCE	MIC / USB / REAR / AUTO
	USB MOD GAIN	0 - 50 - 100
	REAR MOD GAIN	0 - 50 - 100
	RPTT SELECT	OFF / RTS / DTR / DAKY
	NAR WIDTH	300 / 400 / 600 / 850 / 1100 / 1200 / 1500 / 1650 / 1800 1950 / 2100 / 2250 / 2400 / 2450 / 2500 / 2600 / 2700 2800 / 2900 / 3000 / 3200 / 3500 / 4000 (Hz)
	CW AUTO MODE	OFF / 50M / ON
MODE AM	AF TREBLE GAIN	-20 - 0 - 10
	AF MIDDLE TONE GAIN	-20 - 0 - 10
	AF BASS GAIN	-20 - 0 - 10
	AGC FAST DELAY	20 - 1000 - 4000 (20msec/step)
	AGC MID DELAY	20 - 2000 - 4000 (20msec/step)
	AGC SLOW DELAY	20 - 4000 (20msec/step)
	LCUT FREQ	OFF / 100 - 1000 (50Hz/step)
	LCUT SLOPE	6dB/oct / 18dB/oct
	HCUT FREQ	700 - 3000 - 4000 (50Hz/step) / OFF
	HCUT SLOPE	6dB/oct / 18dB/oct
	USB OUT LEVEL	0 - 50 - 100
	REAR OUT LEVEL	0 - 50 - 100
	TX BPF SEL	50-3050 / 100-2900 / 200-2800 / 300-2700 / 400-2600
	MOD SOURCE	MIC / USB / REAR / AUTO
	USB MOD GAIN	0 - 50 - 100
	REAR MOD GAIN	0 - 50 - 100
	RPTT SELECT	OFF / RTS / DTR / DAKY
MODE FM	AF TREBLE GAIN	-20 - 0 - 10
	AF MIDDLE TONE GAIN	-20 - 0 - 10
	AF BASS GAIN	-20 - 0 - 10
	AGC FAST DELAY	20 - 160 - 4000 (20msec/step)
	AGC MID DELAY	20 - 500 - 4000 (20msec/step)
	AGC SLOW DELAY	20 - 1500 - 4000 (20msec/step)
	LCUT FREQ	OFF / 100 - 300 - 1000 (50Hz/step)
	LCUT SLOPE	6dB/oct / 18dB/oct
	HCUT FREQ	700 - 3000 - 4000 (50Hz/step) / OFF
	HCUT SLOPE	6dB/oct / 18dB/oct
	USB OUT LEVEL	0 - 50 - 100
	REAR OUT LEVEL	0 - 50 - 100
	MOD SOURCE	MIC / USB / REAR / AUTO
	USB MOD GAIN	0 - 50 - 100
	REAR MOD GAIN	0 - 50 - 100
	RPTT SELECT	OFF / RTS / DTR / DAKY
	RPT SHIFT	- / SIMP / +
	RPT SHIFT(28MHz)	0 - 100 - 1000 (10kHz/step)

Menu Function		Available Settings (Default: Bold)
	RPT SHIFT(50MHz)	0 - 1000 - 4000 (10kHz/step)
	ENC/DEC	OFF / ENC / TSQ
	TONE FREQ	67.0 - 100.0 - 254.1 (Hz)
MODE PSK/DATA	AF TREBLE GAIN	-20 - 0 - 10
	AF MIDDLE TONE GAIN	-20 - 0 - 10
	AF BASS GAIN	-20 - 0 - 10
	AGC FAST DELAY	20 - 160 - 4000 (20msec/step)
	AGC MID DELAY	20 - 500 - 4000 (20msec/step)
	AGC SLOW DELAY	20 - 1500 - 4000 (20msec/step)
	LCUT FREQ	OFF / 100 - 1000 (50Hz/step)
	LCUT SLOPE	6dB/oct / 18dB/oct
	HCUT FREQ	700 - 3200 - 4000 (50Hz/step) / OFF
	HCUT SLOPE	6dB/oct / 18dB/oct
	USB OUT LEVEL	0 - 50 - 100
	REAR OUT LEVEL	0 - 50 - 100
	TX BPF SEL	50-3050 / 100-2900 / 200-2800 / 300-2700 / 400-2600
	MOD SOURCE	MIC / USB / REAR / AUTO
	USB MOD GAIN	0 - 50 - 100
	REAR MOD GAIN	0 - 50 - 100
	RPTT SELECT	OFF / RTS / DTR / DAKY
	NAR WIDTH	50 / 100 / 150 / 200 / 250 / 300 / 350 / 400 / 450 / 500 / 600 800 / 1200 / 1400 / 1700 / 2000 / 2400 / 3000 / 3200 3500 / 4000 (Hz)
	PSK TONE	1000 / 1500 / 2000 (Hz)
	DATA SHIFT (SSB)	0 - 1500 - 3000 (10Hz/step)
MODE RTTY	AF TREBLE GAIN	-20 - 0 - 10
	AF MIDDLE TONE GAIN	-20 - 0 - 10
	AF BASS GAIN	-20 - 0 - 10
	AGC FAST DELAY	20 - 160 - 4000 (20msec/step)
	AGC MID DELAY	20 - 500 - 4000 (20msec/step)
	AGC SLOW DELAY	20 - 1500 - 4000 (20msec/step)
	LCUT FREQ	OFF / 100Hz - 300Hz - 1000Hz (50Hz/step)
	LCUT SLOPE	6dB/oct / 18dB/oct
	HCUT FREQ	700Hz - 3000Hz - 4000Hz (50Hz/step) / OFF
	HCUT SLOPE	6dB/oct / 18dB/oct
	USB OUT LEVEL	0 - 50 - 100
	REAR OUT LEVEL	0 - 50 - 100
	RPTT SELECT	OFF / RTS / DTR / DAKY
	NAR WIDTH	50 / 100 / 150 / 200 / 250 / 300 / 350 / 400 / 450 / 500 / 600 800 / 1200 / 1400 / 1700 / 2000 / 2400 / 3000 / 3200 / 3500 4000 (Hz)
	MARK FREQUENCY	1275 / 2125 (Hz)
	SHIFT FREQUENCY	170 / 200 / 425 / 850 (Hz)
	POLARITY TX	NOR / REV
CW SETTING		
MODE CW	AF TREBLE GAIN	-20 - 0 - 10
	AF MIDDLE TONE GAIN	-20 - 0 - 10
	AF BASS GAIN	-20 - 0 - 10
	AGC FAST DELAY	20 - 160 - 4000 (20msec/step)
	AGC MID DELAY	20 - 500 - 4000 (20msec/step)
	AGC SLOW DELAY	20 - 1500 - 4000 (20msec/step)
	LCUT FREQ	OFF / 100Hz - 250Hz - 1000Hz (50Hz/step)
	LCUT SLOPE	6dB/oct / 18dB/oct
	HCUT FREQ	700Hz - 1200Hz - 4000Hz (50Hz/step) / OFF
	HCUT SLOPE	6dB/oct / 18dB/oct
	USB OUT LEVEL	0 - 50 - 100
	REAR OUT LEVEL	0 - 50 - 100
	RPTT SELECT	OFF / RTS / DTR / DAKY

Menu Function		Available Settings (Default: Bold)
	NAR WIDTH	50 / 100 / 150 / 200 / 250 / 300 / 350 / 400 / 450 / 500 / 600 / 800 / 1200 / 1400 / 1700 / 2000 / 2400 / 3000 / 3200 / 3500 / 4000 (Hz)
	PC KEYING	OFF / RTS / DTR / DAKY
	CW BK-IN TYPE	SEMI / FULL
	CW WAVE SHAPE	2 / 3 / 4 (msec)
	CW FREQ DISPLAY	DIRECT FREQ / PITCH OFFSET
	QSK DELAY TIME	15 / 20 / 25 / 30 (msec)
	CW INDICATOR	OFF / ON
KEYER	KEYER TYPE	OFF / BUG / ELEKEY-A / ELEKEY-B / ELEKEY-Y / ACS
	KEYER DOT/DASH	NOR / REV
	CW WEIGHT	2.5 - 3.0 - 4.5
	NUMBER STYLE	1290 / AUNO / AUNT / A2NO / A2NT / 12NO / 12NT
	CONTEST NUMBER	1 - 9999
	CW MEMORY 1	TEXT / MESSAGE
	CW MEMORY 2	TEXT / MESSAGE
	CW MEMORY 3	TEXT / MESSAGE
	CW MEMORY 4	TEXT / MESSAGE
	CW MEMORY 5	TEXT / MESSAGE
	REPEAT INTERVAL	1 - 5 - 60 (sec)
OPERATION SETTING		
GENERAL	BEEP LEVEL	0 - 20 - 100
	RF/SQL VR	RF / SQL / SQL(FM only)
	TUN/LIN PORT SELECT	EXT-TUNER / LINEAR / CAT-3 / GP OUT
	TUNER TYPE SELECT	INT / INT(FAST) / EXT / ATAS
	CAT-1 RATE	4800 / 9600 / 19200 / 38400 / 115200 (bps)
	CAT-1 TIME OUT TIMER	10 / 100 / 1000 / 3000 (msec)
	CAT-1 CAT-3 STOP BIT	1bit / 2bit
	CAT-2 RATE	4800 / 9600 / 19200 / 38400 / 115200 (bps)
	CAT-2 TIME OUT TIMER	10 / 100 / 1000 / 3000 (msec)
	CAT-3 RATE	4800 / 9600 / 19200 / 38400 / 115200 (bps)
	CAT-3 TIME OUT TIMER	10 / 100 / 1000 / 3000 (msec)
	QMB CH	5ch / 10ch
	BAND STACK	OFF / ON
	MEM GROUP	OFF / ON
	TX TIME OUT TIMER	OFF / 1 - 30 (min) (10 min , European Version)
	MIC SCAN	OFF / ON
	MIC SCAN RESUME	PAUSE / TIME
	REF FREQ FINE ADJ	-25 - 0 - 25
	KEYBOARD LANGUAGE	JAPANESE / ENGLISH(US) / ENGLISH(UK) / FRENCH / FRENCH(CA) / GERMAN / PORTUGUESE / PORTUGUESE(BR) / SPANISH / SPANISH(LATAM) / ITALIAN Default Setting: Depends on the transceiver version.
	MIC P1 MIC P2 MIC P3 MIC P4 MIC UP MIC DOWN	LOCK / QMB / A/B / V/M / TUNER / VOX/MOX / MODE / ZIN_SPOT / SPLIT / FINE / NAR / NB / DNR / FREQ UP / FREQ DOWN / BAND UP / BAND DOWN / ATT / IPO / DNF / AGC MIC P1: LOCK MIC P2: QMB MIC P3: A/B MIC P4: V/M MIC UP: FREQ UP MIC DOWN: FREQ DOWN
	SCU-LAN10	OFF / ON
RX DSP	IF NOTCH WIDTH	NARROW / WIDE
	NB REJECTION	LOW / MID / HIGH

Menu Function		Available Settings (Default: Bold)
	NB WIDTH	NARROW / MEDIUM / WIDE
	APF WIDTH	NARROW / MEDIUM / WIDE
	CONTOUR LEVEL	-40 - -15 - 0 - 20
	CONTOUR WIDTH	1 - 10 - 11
TX AUDIO	AMC RELEASE TIME	FAST / MID / SLOW
	PRMTRC EQ1 FREQ	OFF / 100 - 700 (100Hz/step)
	PRMTRC EQ1 LEVEL	-20 - 0 - 5 - 10
	PRMTRC EQ1 BWTH	0 - 10
	PRMTRC EQ2 FREQ	OFF / 700 - 1500 (100Hz/step)
	PRMTRC EQ2 LEVEL	-20 - 0 - 5 - 10
	PRMTRC EQ2 BWTH	0 - 10
	PRMTRC EQ3 FREQ	OFF / 1500 - 3200 (100Hz/step)
	PRMTRC EQ3 LEVEL	-20 - 0 - 5 - 10
	PRMTRC EQ3 BWTH	0 - 10
	P PRMTRC EQ1 FREQ	OFF / 100 - 700 (100Hz/step)
	P PRMTRC EQ1 LEVEL	-20 - 0 - 10
	P PRMTRC EQ1 BWTH	0 - 2 - 10
	P PRMTRC EQ2 FREQ	OFF / 700 - 1500 (100Hz/step)
	P PRMTRC EQ2 LEVEL	-20 - 0 - 10
	P PRMTRC EQ2 BWTH	0 - 1 - 10
	P PRMTRC EQ3 FREQ	OFF / 1500 - 3200 (100Hz/step)
	P PRMTRC EQ3 LEVEL	-20 - 0 - 10
	P PRMTRC EQ3 BWTH	0 - 1 - 10
TX GENERAL	HF MAX POWER	5 - 100 (W)
	50M MAX POWER	5 - 100 (W)
	70M MAX POWER	5 - 50 (W)
	AM MAX POWER	5 - 25 (W)
	VOX SELECT	MIC / USB / REAR
	EMERGENCY FREQ TX	OFF / ON
	TX INHIBIT	OFF / ON
	METER DETECTOR	AVERAGE / PEAK
TUNING	SSB/CW DIAL STEP	5 / 10 / 20 (Hz)
	RTTY/PSK DIAL STEP	5 / 10 / 20 (Hz)
	CH STEP	1 / 2.5 / 5 / 10 (kHz)
	AM CH STEP	2.5 / 5 / 9 / 10 / 12.5 / 25 (kHz)
	FM CH STEP	5 / 6.25 / 10 / 12.5 / 20 / 25 (kHz)
	MAIN STEPS PER REV.	50 / 100 / 200
DISPLAY SETTING		
DISPLAY	MY CALL	Max 12 characters (FT-710)
	MY CALL TIME	OFF / 1 / 2 / 3 / 4 / 5 (sec)
	POP-UP TIME	FAST / MID / SLOW
	SCREEN SAVER	OFF / 15 / 30 / 60 (min)
	LED DIMMER	OFF / 1 - 20
	MOUSE POINTER SPEED	0 - 10 - 20
SCOPE	RBW	HIGH / MID / LOW
	SCOPE CTR	FILTER / CARRIER
	2D DISP SENSITIVITY	NORMAL / HI
	3DSS DISP SENSITIVITY	NORMAL / HI
VFO IND COLOR	VMI COLOR VFO-A	BLUE / GREEN / RED / NONE
	VMI COLOR VFO-B	BLUE / GREEN / RED / NONE
	VMI COLOR MEMORY	BLUE / GREEN / WHITE / NONE
	VMI COLOR CLAR	RED / NONE
EXT MONITOR	EXT DISPLAY	OFF / ON
	PIXEL	800x480 / 800x600
EXTENSION SETTING		
DATE&TIME	DAY	-
	MONTH	-

Menu Function		Available Settings (Default: Bold)
	YEAR	-
	HOUR	-
	MINUTE	-
SD CARD	MEM LIST LOAD	-
	MEM LIST SAVE	-
	MENU LOAD	-
	MENU SAVE	-
	INFORMATIONS	-
	FIRMWARE UPDATE	-
	FORMAT	-
SOFT VERSION		-
CALIBRATION	CALIBRATION	-
RESET	MEMORY CLEAR	-
	MENU CLEAR	-
	ALL RESET	-

RADIO SETTING - MODE SSB -

AF TREBLE GAIN

Function: Sets the amount of gain in the treble range of the received audio.

Available Values: -20 to +10

Default Setting: 0

Description: The amount of gain in the treble range can be set in the range of -20 to +10.

AF MIDDLE TONE GAIN

Function: Setting the amount of gain in the middle range of the received audio.

Available Values: -20 to +10

Default Setting: 0

Description: The amount of gain in the middle range can be set in the range of -20 to +10.

AF BASS GAIN

Function: Setting the amount of gain in the bass range of the received audio.

Available Values: -20 to +10

Default Setting: 0

Description: The amount of gain in the bass range can be set in the range of -20 to +10.

AGC FAST DELAY

Function: Sets the AGC-FAST DELAY voltage decay characteristics for SSB mode.

Available Values: 20 - 4000msec

Default Setting: 300msec

Description: Sets the AGC voltage decay characteristics in 20msec steps after the input signal level becomes lower than the AGC detection level and the HOLD time has expired.

AGC MID DELAY

Function: Sets the AGC-MID DELAY voltage decay characteristics for SSB mode.

Available Values: 20 - 4000msec

Default Setting: 1000msec

Description: Sets the AGC voltage decay characteristics in 20msec steps after the input signal level becomes lower than the AGC detection level and the HOLD time has expired.

AGC SLOW DELAY

Function: Sets the AGC-SLOW DELAY voltage decay characteristics for SSB mode.

Available Values: 20 - 4000msec

Default Setting: 3000msec

Description: Sets the AGC voltage decay characteristics in 20msec steps after the input signal level becomes lower than the AGC detection level and the HOLD time has expired.

LCUT FREQ

Function: Sets the low-frequency cutoff audio filter in SSB mode.

Available Values: OFF / 100Hz - 1000Hz

Default Setting: 100Hz

Description: The cutoff frequency can be set at 50Hz increments between 100Hz and 1000Hz.

LCUT SLOPE

Function: Sets the slope of the low-frequency cutoff audio filter in SSB mode.

Available Values: 6dB/oct / 18dB/oct

Default Setting: 6dB/oct

HCUT FREQ

Function: Sets the high-frequency cutoff audio filter in SSB mode.

Available Values: 700Hz - 4000Hz / OFF

Default Setting: 3000Hz

Description: The cutoff frequency can be set at 50Hz increments between 700Hz and 4000Hz.

HCUT SLOPE

Function: Sets the slope of the high-frequency cutoff audio filter in SSB mode.

Available Values: 6dB/oct / 18dB/oct

Default Setting: 6dB/oct

USB OUT LEVEL

Function: Sets the level of the receive SSB signal output from the USB jack.

Available Values: 0 - 100

Default Setting: 50

REAR OUT LEVEL

Function: Sets the level of the receive SSB signal output from the RTTY/DATA jack.

Available Values: 0 - 100

Default Setting: 50

TX BPF SEL

Function: Selects the audio passband of the DSP modulator on the SSB mode.

Available Values: 50-3050 / 100-2900 / 200-2800 / 300-2700 / 400-2600 (Hz)

Default Setting: 100-2900 Hz

MOD SOURCE

Function: Selects the transmit audio input jack in the SSB mode.

Available Values: MIC / USB / REAR / AUTO

Default Setting: AUTO

Description:

MIC: Audio is input from the MIC jack on the front panel.

USB: Disables the microphone circuit on the front panel and inputs audio/data from the USB jack on the rear panel.

REAR: Disables the microphone circuit on the front panel and inputs audio/data from the RTTY/DATA jack on the rear panel.

AUTO: Modulation is automatically selected according to the transmission method.

PTT: The MIC jack on the front panel.

MOX: The MIC jack on the front panel.

CAT: The USB jack on the rear panel.

DAKY: The RTTY/DATA jack on the rear panel.

RTS: The USB jack on the rear panel.

DTR: The USB jack on the rear panel.

VOX: Terminal set with "VOX SELECT".

USB MOD GAIN

Function: Sets the level of the SSB signal input when "MOD SOURCE" is set to "USB".

Available Values: 0 - 100

Default Setting: 50

REAR MOD GAIN

Function: Sets the level of the SSB signal input when "MOD SOURCE" is set to "REAR".

Available Values: 0 - 100

Default Setting: 50

RPTT SELECT

Function: Sets the PTT control for the SSB transmit signal.

Available Values: OFF / RTS / DTR / DAKY

Default Setting: OFF

Description:

OFF: No PTT control.

RTS: Controls the SSB transmit signal from the USB virtual COM/RTS ports.

DTR: Controls the SSB transmit signal from the USB virtual COM/DTR ports.

DAKY: Controls the SSB transmit signal from the RTTY/DATA jack (pin 3) on the rear panel.

NAR WIDTH

Function: Sets the IF BANDWIDTH of the digital filter when the [NAR] key is pressed in LSB/USB mode.

Available Values: 300 / 400 / 600 / 850 / 1100 / 1200 / 1500 / 1650 / 1800 / 1950 / 2100 / 2250 / 2400 / 2450 / 2500 / 2600 / 2700 / 2800 / 2900 / 3000 / 3200 / 3500 / 4000 (Hz)

Default Setting: 1500Hz

CW AUTO MODE

Function: Enables/disables CW keying while operating on SSB.

Available Values: OFF / 50M (50MHz) / ON

Default Setting: OFF

Description:

OFF: Disables CW keying while operating on SSB.

50M: Enables CW keying while operating SSB on 50 MHz (but not HF).

ON: Enables CW keying while operating SSB on all TX bands.

RADIO SETTING - MODE AM -

AF TREBLE GAIN

Function: Sets the amount of gain in the treble range of the received audio.

Available Values: -20 to +10

Default Setting: 0

Description: The amount of gain in the treble range can be set in the range of -20 to +10.

AF MIDDLE TONE GAIN

Function: Setting the amount of gain in the middle range of the received audio.

Available Values: -20 to +10

Default Setting: 0

Description: The amount of gain in the middle range can be set in the range of -20 to +10.

AF BASS GAIN

Function: Setting the amount of gain in the bass range of the received audio.

Available Values: -20 to +10

Default Setting: 0

Description: The amount of gain in the bass range can be set in the range of -20 to +10.

AGC FAST DELAY

Function: Sets the AGC-FAST DELAY voltage decay characteristics for AM mode.

Available Values: 20 - 4000msec

Default Setting: 1000msec

Description: Sets the AGC voltage decay characteristics in 20msec steps after the input signal level becomes lower than the AGC detection level and the HOLD time has expired.

AGC MID DELAY

Function: Sets the AGC-MID DELAY voltage decay characteristics for AM mode.

Available Values: 20 - 4000msec

Default Setting: 2000msec

Description: Sets the AGC voltage decay characteristics in 20msec steps after the input signal level becomes lower than the AGC detection level and the HOLD time has expired.

AGC SLOW DELAY

Function: Sets the AGC-SLOW DELAY voltage decay characteristics for AM mode.

Available Values: 20 - 4000msec

Default Setting: 4000msec

Description: Sets the AGC voltage decay characteristics in 20msec steps after the input signal level becomes lower than the AGC detection level and the HOLD time has expired.

LCUT FREQ

Function: Sets the low-frequency cutoff audio filter in AM mode.

Available Values: OFF / 100Hz - 1000Hz

Default Setting: OFF

Description: The cutoff frequency can be set at 50Hz increments between 100Hz and 1000Hz.

LCUT SLOPE

Function: Sets the slope of the low-frequency cutoff audio filter in AM mode.

Available Values: 6dB/oct / 18dB/oct

Default Setting: 6dB/oct

HCUT FREQ

Function: Sets the high-frequency cutoff audio filter in AM mode.

Available Values: 700Hz - 4000Hz / OFF

Default Setting: OFF

Description: The cutoff frequency can be set at 50Hz increments between 700Hz and 4000Hz.

HCUT SLOPE

Function: Sets the slope of the high-frequency cutoff audio filter in AM mode.

Available Values: 6dB/oct / 18dB/oct

Default Setting: 6dB/oct

USB OUT LEVEL

Function: Sets the level of the receive AM signal output from the USB jack.

Available Values: 0 - 100

Default Setting: 50

REAR OUT LEVEL

Function: Sets the level of the receive AM signal output from the RTTY/DATA jack.

Available Values: 0 - 100

Default Setting: 50

TX BPF SEL

Function: Selects the audio passband of the DSP modulator on the AM mode.

Available Values: 50-3050 / 100-2900 / 200-2800 / 300-2700 / 400-2600 (Hz)

Default Setting: 50-3050 Hz

MOD SOURCE

Function: Selects the transmit audio input jack in the AM mode.

Available Values: MIC / USB / REAR / AUTO

Default Setting: AUTO

Description:

MIC: Audio is input from the MIC jack on the front panel.

USB: Disables the microphone circuit on the front panel and inputs audio/data from the USB jack on the rear panel.

REAR: Disables the microphone circuit on the front panel and inputs audio/data from the RTTY/DATA jack on the rear panel.

AUTO: Modulation is automatically selected according to the transmission method.

PTT: The MIC jack on the front panel.

MOX: The MIC jack on the front panel.

CAT: The USB jack on the rear panel.

DAKY: The RTTY/DATA jack on the rear panel.

RTS: The USB jack on the rear panel.

DTR: The USB jack on the rear panel.

VOX: Terminal set with "VOX SELECT".

USB MOD GAIN

Function: Sets the level of the AM signal input when "MOD SOURCE" is set to "USB".

Available Values: 0 - 100

Default Setting: 50

REAR MOD GAIN

Function: Sets the level of the AM signal input when "MOD SOURCE" is set to "REAR".

Available Values: 0 - 100

Default Setting: 50

RPTT SELECT

Function: Sets the PTT control for the AM transmit signal.

Available Values: OFF / RTS / DTR / DAKY

Default Setting: OFF

Description:

OFF: No PTT control.

RTS: Controls the AM transmit signal from the USB virtual COM/RTS ports.

DTR: Controls the AM transmit signal from the USB virtual COM/DTR ports.

DAKY: Controls the AM transmit signal from the RTTY/DATA jack (pin 3) on the rear panel.

RADIO SETTING - MODE FM -

AF TREBLE GAIN

Function: Sets the amount of gain in the treble range of the received audio.

Available Values: -20 to +10

Default Setting: 0

Description: The amount of gain in the treble range can be set in the range of -20 to +10.

AF MIDDLE TONE GAIN

Function: Setting the amount of gain in the middle range of the received audio.

Available Values: -20 to +10

Default Setting: 0

Description: The amount of gain in the middle range can be set in the range of -20 to +10.

AF BASS GAIN

Function: Setting the amount of gain in the bass range of the received audio.

Available Values: -20 to +10

Default Setting: 0

Description: The amount of gain in the bass range can be set in the range of -20 to +10.

AGC FAST DELAY

Function: Sets the AGC-FAST DELAY voltage decay characteristics for FM mode.

Available Values: 20 - 4000msec

Default Setting: 160msec

Description: Sets the AGC voltage decay characteristics in 20msec steps after the input signal level becomes lower than the AGC detection level and the HOLD time has expired.

AGC MID DELAY

Function: Sets the AGC-MID DELAY voltage decay characteristics for FM mode.

Available Values: 20 - 4000msec

Default Setting: 500msec

Description: Sets the AGC voltage decay characteristics in 20msec steps after the input signal level becomes lower than the AGC detection level and the HOLD time has expired.

AGC SLOW DELAY

Function: Sets the AGC-SLOW DELAY voltage decay characteristics for FM mode.

Available Values: 20 - 4000msec

Default Setting: 1500msec

Description: Sets the AGC voltage decay characteristics in 20msec steps after the input signal level becomes lower than the AGC detection level and the HOLD time has expired.

LCUT FREQ

Function: Sets the low-frequency cutoff audio filter in FM mode.

Available Values: OFF / 100Hz - 1000Hz

Default Setting: 300

Description: The cutoff frequency can be set at 50Hz increments between 100Hz and 1000Hz.

LCUT SLOPE

Function: Sets the slope of the low-frequency cutoff audio filter in FM mode.

Available Values: 6dB/oct / 18dB/oct

Default Setting: 18dB/oct

HCUT FREQ

Function: Sets the high-frequency cutoff audio filter in FM mode.

Available Values: 700Hz - 4000Hz/OFF

Default Setting: 3000Hz

Description: The cutoff frequency can be set at 50Hz increments between 700Hz and 4000Hz.

HCUT SLOPE

Function: Sets the slope of the high-frequency cutoff audio filter in FM mode.

Available Values: 6dB/oct / 18dB/oct

Default Setting: 18dB/oct

USB OUT LEVEL

Function: Sets the level of the receive FM signal output from the USB jack.

Available Values: 0 - 100

Default Setting: 50

REAR OUT LEVEL

Function: Sets the level of the receive FM signal output from the RTTY/DATA jack.

Available Values: 0 - 100

Default Setting: 50

MOD SOURCE

Function: Selects the transmit audio input jack in the FM mode.

Available Values: MIC / USB / REAR / AUTO

Default Setting: AUTO

Description:

MIC: Audio is input from the MIC jack on the front panel.

USB: Disables the microphone circuit on the front panel and inputs audio/data from the USB jack on the rear panel.

REAR: Disables the microphone circuit on the front panel and inputs audio/data from the RTTY/DATA jack on the rear panel.

AUTO: Modulation is automatically selected according to the transmission method.

PTT: The MIC jack on the front panel.

MOX: The MIC jack on the front panel.

CAT: The USB jack on the rear panel.

DAKY: The RTTY/DATA jack on the rear panel.

RTS: The USB jack on the rear panel.

DTR: The USB jack on the rear panel.

VOX: Terminal set with "VOX SELECT".

USB MOD GAIN

Function: Sets the level of the FM signal input when "MOD SOURCE" is set to "USB".

Available Values: 0 - 100

Default Setting: 50

REAR MOD GAIN

Function: Sets the level of the FM signal input when "MOD SOURCE" is set to "REAR".

Available Values: 0 - 100

Default Setting: 50

RPTT SELECT

Function: Sets the PTT control for the FM transmit signal.

Available Values: OFF / RTS / DTR / DAKY

Default Setting: OFF

Description:

OFF: No PTT control.

RTS: Controls the FM transmit signal from the USB virtual COM/RTS ports.

DTR: Controls the FM transmit signal from the USB virtual COM/DTR ports.

DAKY: Controls the FM transmit signal from the RTTY/DATA jack (pin 3) on the rear panel.

RPT SHIFT

Function: Sets the Repeater Shift Direction.

Available Values: - / SIMP / +

Default Setting: SIMP

Description:

-: Shifts to the lower frequency offset.

SIMP: The frequency does not shift.

+: Shifts to the higher frequency offset.

RPT SHIFT(28MHz)

Function: Sets the RPT offset frequency on the 28MHz band.

Available Values: 0 - 1000kHz

Default Setting: 100kHz

Description: The RPT offset frequency can be set at 10kHz increments between 0kHz and 1000kHz.

RPT SHIFT(50MHz)

Function: Sets the RPT offset frequency on the 50MHz band.

Available Values: 0 - 4000kHz

Default Setting: 1000kHz

Description: The RPT offset frequency can be set at 10kHz increments between 0kHz and 4000kHz.

ENC/DEC

Function: Selects the Tone Encoder and/or Decoder mode.

Available Values: OFF / ENC / TSQ

Default Setting: OFF

Description:

ENC: CTCSS Encoder

TSQ: CTCSS Encoder/Decoder

TONE FREQ

Function: Setting of the CTCSS Tone Frequency.

Available Values: 50 standard CTCSS tones

Default Setting: 100.0Hz

RADIO SETTING - MODE PSK/DATA -

AF TREBLE GAIN

Function: Sets the amount of gain in the treble range of the received audio.

Available Values: -20 to +10

Default Setting: 0

Description: The amount of gain in the treble range can be set in the range of -20 to +10.

AF MIDDLE TONE GAIN

Function: Setting the amount of gain in the middle range of the received audio.

Available Values: -20 to +10

Default Setting: 0

Description: The amount of gain in the middle range can be set in the range of -20 to +10.

AF BASS GAIN

Function: Setting the amount of gain in the bass range of the received audio.

Available Values: -20 to +10

Default Setting: 0

Description: The amount of gain in the bass range can be set in the range of -20 to +10.

AGC FAST DELAY

Function: Sets the AGC-FAST DELAY voltage decay characteristics for PSK/DATA mode.

Available Values: 20 - 4000msec

Default Setting: 160msec

Description: Sets the AGC voltage decay characteristics in 20msec steps after the input signal level becomes lower than the AGC detection level and the HOLD time has expired.

AGC MID DELAY

Function: Sets the AGC-MID DELAY voltage decay characteristics for PSK/DATA mode.

Available Values: 20 - 4000msec

Default Setting: 500msec

Description: Sets the AGC voltage decay characteristics in 20msec steps after the input signal level becomes lower than the AGC detection level and the HOLD time has expired.

AGC SLOW DELAY

Function: Sets the AGC-SLOW DELAY voltage decay characteristics for PSK/DATA mode.

Available Values: 20 - 4000msec

Default Setting: 1500msec

Description: Sets the AGC voltage decay characteristics in 20msec steps after the input signal level becomes lower than the AGC detection level and the HOLD time has expired.

LCUT FREQ

Function: Sets the low-frequency cutoff audio filter in DATA mode.

Available Values: OFF / 100Hz - 1000Hz

Default Setting: 100

Description: The cutoff frequency can be set at 50Hz increments between 100Hz and 1000Hz.

LCUT SLOPE

Function: Sets the slope of the low-frequency cutoff audio filter in DATA mode.

Available Values: 6dB/oct / 18dB/oct

Default Setting: 18dB/oct

HCUT FREQ

Function: Sets the high-frequency cutoff audio filter in DATA mode.

Available Values: 700Hz - 4000Hz / OFF

Default Setting: 3200Hz

Description: The cutoff frequency can be set at 50Hz increments between 700Hz and 4000Hz.

HCUT SLOPE

Function: Sets the slope of the high-frequency cutoff audio filter in DATA mode.

Available Values: 6dB/oct / 18dB/oct

Default Setting: 18dB/oct

USB OUT LEVEL

Function: Sets the level of the receive DATA signal output from the USB jack.

Available Values: 0 - 100

Default Setting: 50

REAR OUT LEVEL

Function: Sets the level of the receive DATA signal output from the RTTY/DATA jack.

Available Values: 0 - 100

Default Setting: 50

TX BPF SEL

Function: Selects the audio passband of the DSP modulator on the DATA mode.

Available Values: 50-3050 / 100-2900 / 200-2800 / 300-2700 / 400-2600 (Hz)

Default Setting: 50-3050 Hz

MOD SOURCE

Function: Selects the transmit audio input jack in the DATA mode.

Available Values: MIC / USB / REAR / AUTO

Default Setting: AUTO

Description:

MIC: Audio is input from the MIC jack on the front panel.

USB: Disables the microphone circuit on the front panel and inputs audio/data from the USB jack on the rear panel.

REAR: Disables the microphone circuit on the front panel and inputs audio/data from the RTTY/DATA jack on the rear panel.

AUTO: Modulation is automatically selected according to the transmission method.

PTT: The MIC jack on the front panel.

MOX: The MIC jack on the front panel.

CAT: The USB jack on the rear panel.

DAKY: The RTTY/DATA jack on the rear panel.

RTS: The USB jack on the rear panel.

DTR: The USB jack on the rear panel.

VOX: Terminal set with "VOX SELECT".

USB MOD GAIN

Function: Sets the level of the DATA signal input when "MOD SOURCE" is set to "USB".

Available Values: 0 - 100

Default Setting: 50

REAR MOD GAIN

Function: Sets the level of the DATA signal input when "MOD SOURCE" is set to "REAR".

Available Values: 0 - 100

Default Setting: 50

RPTT SELECT

Function: Sets the PTT control for the DATA transmit signal.

Available Values: OFF / RTS / DTR / DAKY

Default Setting: OFF

Description:

OFF: No PTT control.

RTS: Controls the DATA transmit signal from the USB virtual COM/RTS ports.

DTR: Controls the DATA transmit signal from the USB virtual COM/DTR ports.

DAKY: Controls the DATA transmit signal from the RTTY/DATA jack (pin 3) on the rear panel.

NAR WIDTH

Function: Sets the IF BANDWIDTH of the digital filter when the [NAR] key is pressed in DATA mode.

Available Values: 50 / 100 / 150 / 200 / 250 / 300 / 350 / 400 / 450 / 500 / 600 / 800 / 1200 / 1400 / 1700 / 2000 / 2400 / 3000 / 3200 / 3500 / 4000 (Hz)

Default Setting: 300Hz

PSK TONE

Function: Set the PSK tone

Available Values: 1000 / 1500 / 2000 (Hz)

Default Setting: 1000Hz

DATA SHIFT (SSB)

Function: Sets the carrier point in DATA mode.

Available Values: 0 - 3000 (Hz)

Default Setting: 1500Hz

Description: The frequency can be set in steps of 10Hz.

RADIO SETTING - MODE RTTY -

AF TREBLE GAIN

Function: Sets the amount of gain in the treble range of the received audio.

Available Values: -20 to +10

Default Setting: 0

Description: The amount of gain in the treble range can be set in the range of -20 to +10.

AF MIDDLE TONE GAIN

Function: Setting the amount of gain in the middle range of the received audio.

Available Values: -20 to +10

Default Setting: 0

Description: The amount of gain in the middle range can be set in the range of -20 to +10.

AF BASS GAIN

Function: Setting the amount of gain in the bass range of the received audio.

Available Values: -20 to +10

Default Setting: 0

Description: The amount of gain in the bass range can be set in the range of -20 to +10.

AGC FAST DELAY

Function: Sets the AGC-FAST DELAY voltage decay characteristics for RTTY mode.

Available Values: 20 - 4000msec

Default Setting: 160msec

Description: Sets the AGC voltage decay characteristics in 20msec steps after the input signal level becomes lower than the AGC detection level and the HOLD time has expired.

AGC MID DELAY

Function: Sets the AGC-MID DELAY voltage decay characteristics for RTTY mode.

Available Values: 20 - 4000msec

Default Setting: 500msec

Description: Sets the AGC voltage decay characteristics in 20msec steps after the input signal level becomes lower than the AGC detection level and the HOLD time has expired.

AGC SLOW DELAY

Function: Sets the AGC-SLOW DELAY voltage decay characteristics for RTTY mode.

Available Values: 20 - 4000msec

Default Setting: 1500msec

Description: Sets the AGC voltage decay characteristics in 20msec steps after the input signal level becomes lower than the AGC detection level and the HOLD time has expired.

LCUT FREQ

Function: Sets the low-frequency cutoff audio filter in RTTY mode.

Available Values: OFF / 100Hz - 1000Hz

Default Setting: 300Hz

Description: The cutoff frequency can be set at 50Hz increments between 100Hz and 1000Hz.

LCUT SLOPE

Function: Sets the slope of the low-frequency cutoff audio filter in RTTY mode.

Available Values: 6dB/oct / 18dB/oct

Default Setting: 18dB/oct

HCUT FREQ

Function: Sets the high-frequency cutoff audio filter in RTTY mode.

Available Values: 700Hz - 4000Hz / OFF

Default Setting: 3000Hz

Description: The cutoff frequency can be set at 50Hz increments between 700Hz and 4000Hz.

HCUT SLOPE

Function: Sets the slope of the high-frequency cutoff audio filter in RTTY mode.

Available Values: 6dB/oct / 18dB/oct

Default Setting: 18dB/oct

USB OUT LEVEL

Function: Sets the level of the receive RTTY signal output from the USB jack.

Available Values: 0 - 100

Default Setting: 50

REAR OUT LEVEL

Function: Sets the level of the receive RTTY signal output from the RTTY/DATA jack.

Available Values: 0 - 100

Default Setting: 50

RPTT SELECT

Function: Sets the PTT control for the RTTY transmit signal.

Available Values: OFF / RTS / DTR / DAKY

Default Setting: OFF

Description:

OFF: No PTT control.

RTS: Controls the RTTY transmit signal from the USB virtual COM/RTS ports.

DTR: Controls the RTTY transmit signal from the USB virtual COM/DTR ports.

DAKY: Controls the RTTY transmit signal from the RTTY/DATA jack (pin 3) on the rear panel.

NAR WIDTH

Function: Sets the IF BANDWIDTH of the digital filter when the [NAR] key is pressed in RTTY mode.

Available Values: 50 / 100 / 150 / 200 / 250 / 300 / 350 / 400 / 450 / 500 / 600 / 800 / 1200 / 1400 / 1700 / 2000 / 2400 / 3000 / 3200 / 3500 / 4000 (Hz)

Default Setting: 300Hz

MARK FREQUENCY

Function: Sets the mark frequency for RTTY mode.

Available Values: 1275 / 2125 (Hz)

Default Setting: 2125Hz

SHIFT FREQUENCY

Function: Sets the shift width for RTTY mode.

Available Values: 170 / 200 / 425 / 850 (Hz)

Default Setting: 170Hz

POLARITY TX

Function: Sets the shift direction for transmitting in RTTY mode.

Available Values: NOR / REV

Default Setting: NOR

Description:

NOR: The space frequency will be lower than the mark frequency.

REV: The mark frequency will be lower than the space frequency.

CW SETTING - MODE CW -

AF TREBLE GAIN

Function: Sets the amount of gain in the treble range of the received audio.

Available Values: -20 to +10

Default Setting: 0

Description: The amount of gain in the treble range can be set in the range of -20 to +10.

AF MIDDLE TONE GAIN

Function: Setting the amount of gain in the middle range of the received audio.

Available Values: -20 to +10

Default Setting: 0

Description: The amount of gain in the middle range can be set in the range of -20 to +10.

AF BASS GAIN

Function: Setting the amount of gain in the bass range of the received audio.

Available Values: -20 to +10

Default Setting: 0

Description: The amount of gain in the bass range can be set in the range of -20 to +10.

AGC FAST DELAY

Function: Sets the AGC-FAST DELAY voltage decay characteristics for CW mode.

Available Values: 20 - 4000msec

Default Setting: 160msec

Description: Sets the AGC voltage decay characteristics in 20 msec steps after the input signal level becomes lower than the AGC detection level and the HOLD time has expired.

AGC MID DELAY

Function: Sets the AGC-MID DELAY voltage decay characteristics for CW mode.

Available Values: 20 - 4000msec

Default Setting: 500msec

Description: Sets the AGC voltage decay characteristics in 20msec steps after the input signal level becomes lower than the AGC detection level and the HOLD time has expired.

AGC SLOW DELAY

Function: Sets the AGC-SLOW DELAY voltage decay characteristics for CW mode.

Available Values: 20 - 4000msec

Default Setting: 1500msec

Description: Sets the AGC voltage decay characteristics in 20msec steps after the input signal level becomes lower than the AGC detection level and the HOLD time has expired.

LCUT FREQ

Function: Sets the low-frequency cutoff audio filter in CW mode.

Available Values: OFF / 100Hz - 1000Hz

Default Setting: 250Hz

Description: The cutoff frequency can be set at 50Hz increments between 100Hz and 1000Hz.

LCUT SLOPE

Function: Sets the slope of the low-frequency cutoff audio filter in CW mode.

Available Values: 6dB/oct / 18dB/oct

Default Setting: 18dB/oct

HCUT FREQ

Function: Sets the high-frequency cutoff audio filter in CW mode.

Available Values: 700Hz - 4000Hz / OFF

Default Setting: 1200Hz

Description: The cutoff frequency can be set at 50Hz increments between 700Hz and 4000Hz.

HCUT SLOPE

Function: Sets the slope of the high-frequency cutoff audio filter in CW mode.

Available Values: 6dB/oct / 18dB/oct

Default Setting: 18dB/oct

USB OUT LEVEL

Function: Sets the level of the receive CW signal output from the USB jack.

Available Values: 0 - 100

Default Setting: 50

REAR OUT LEVEL

Function: Sets the level of the receive CW signal output from the RTTY/DATA jack.

Available Values: 0 - 100

Default Setting: 50

RPTT SELECT

Function: Sets the PTT control for the CW transmit signal.

Available Values: OFF / RTS / DTR / DAKY

Default Setting: OFF

Description:

OFF: No PTT control.

RTS: Controls the CW transmit signal from the USB virtual COM/RTS ports.

DTR: Controls the CW transmit signal from the USB virtual COM/DTR ports.

DAKY: Controls the CW transmit signal from the RTTY/DATA jack (pin 3) on the rear panel.

NAR WIDTH

Function: Sets the IF BANDWIDTH of the digital filter when the [NAR] key is pressed in CW mode.

Available Values: 50 / 100 / 150 / 200 / 250 / 300 / 350 / 400 / 450 / 500 / 600 / 800 / 1200 / 1400 / 1700 / 2000 / 2400 / 3000 / 3200 / 3500 / 4000 (Hz)

Default Setting: 250Hz

PC KEYING

Function: Sets the RTTY/DATA jack for PC keying.

Available Values: OFF / RTS / DTR / DAKY

Default Setting: OFF

Description:

OFF: Disables PC keying from DATA PTT (pin 3) of the RTTY/DATA jack.

RTS: Controls the transmit from the USB virtual COM/RTS ports.

DTR: Controls the transmit from the USB virtual COM/DTR ports.

DAKY: Controls the transmit from the RTTY/DATA jack (pin 3) on the rear panel.

CW BK-IN TYPE

Function: Sets the CW brake-in function.

Available Values: SEMI / FULL

Default Setting: SEMI

Description:

SEMI: A brief delay is provided after the CW keying operation, before the transceiver returns to receive mode.

The receiver recovery time may be changed using "CW BK-IN DELAY".

FULL: The transceiver immediately returns to receive mode after every CW key-up (QSK mode).

CW WAVE SHAPE

Function: Selects the CW carrier wave-form shape (rise/fall times).

Available Values: 2msec / 3msec / 4msec

Default Setting: 4msec

Description: Sets the rise and fall times of the keying envelope in CW mode (transmit waveform).

*Settings of 2ms or 3ms may cause Key Clicks.

CW FREQ DISPLAY

Function: Sets the PITCH frequency offset.

Available Values: DIRECT FREQ / PITCH OFFSET

Default Setting: PITCH OFFSET

Description: Sets the displayed frequency offset when switching the transceiver mode between SSB and CW.

DIRECT FREQ: Displays the same frequency in CW mode as in SSB mode without any offset added.

PITCH OFFSET: Displays the frequency in CW mode with the pitch offset added. When CW BFO is set to USB, the displayed frequency will be increased and when CW BFO is set to LSB, the displayed frequency will be decreased with pitch offset added.

QSK DELAY TIME

Function: Sets the time delay before transmitting the keying signal.

Available Values: 15 / 20 / 25 / 30 msec

Default Setting: 15 msec

Description: The QSK mode delay time before transmitting the CW signal may be set in 5msec steps.

Notes:

- When the keying speed of the CW is "45 wpm" or more, delay time will be "15 msec" regardless of the delay time setting.
- This setting is valid in all communication modes and the set TX delay time works effectively for the TX GND pin of the LINEAR jack on the rear panel.

CW INDICATOR

Function: Bar display settings shown below the filter function display in CW mode.

Available Values: OFF / ON

Default Setting: ON

Description: In CW mode, the bar shown below the filter function display may be set to ON or OFF.

CW SETTING

- KEYER -

KEYER TYPE

Function: Selects the desired keyer operation mode for the device connected to the rear panel KEY jack.

Available Values: OFF / BUG / ELEKEY-A / ELEKEY-B / ELEKEY-Y / ACS

Default Setting: ELEKEY-B

Description:

OFF: Disables the keyer function.

BUG: Functions as a "BUG key". Only the "Dot" side is automatically generated (the "Dash" side is generated manually).

ELEKEY-A: A code element ("Dot" or "Dash" side) is transmitted upon pressing both sides of the paddle.

ELEKEY-B: Pressing both sides of the paddle transmits the currently generated "Dash" side followed by "Dot" side (or reverse order).

ELEKEY-Y: Pressing both sides of the paddle transmits the currently generated "Dash" side followed by "Dot" side (or reverse order).

While transmitting the "Dash" side, the first transmitted "Dot" side will not be stored.

ACS: Functions as the "Keyer with automatic spacing control feature" which sets spacing between characters precisely to be the same length as a dash (three dots in length).

KEYER DOT/DASH

Function: Selects the keyer paddle wiring configuration for the KEY jack on the front panel.

Available Values: NOR / REV

Default Setting: NOR

Description:

NOR: Tip = Dot, Ring = Dash, Shaft = Ground.

REV: Tip = Dash, Ring = Dot, Shaft = Ground.

CW WEIGHT

Function: Adjusts the keyer CW weight.

Available Values: 2.5 - 4.5

Default Setting: 3.0

Description: Sets the "Dot": "Dash" ratio for the built-in electronic keyer.

NUMBER STYLE

Function: Selects the contest number "Cut" format for an imbedded contest number.

Available Values: 1290 / AUNO / AUNT / A2NO / A2NT / 12NO / 12NT

Default Setting: 1290

Description: Abbreviates numbers "One", "Two", "Nine" and "Zero" using Morse code when sending the contest number.

1290: Does not abbreviate the contest number.

AUNO: Abbreviates to "A" for "One", "U" for "Two", "N" for "Nine", and "O" for "Zero".

AUNT: Abbreviates to "A" for "One", "U" for "Two", "N" for "Nine", and "T" for "Zero".

A2NO: Abbreviates to "A" for "One", "N" for "Nine", and "O" for "Zero". Does not abbreviate number "Two".

A2NT: Abbreviates to "A" for "One", "N" for "Nine", and "T" for "Zero". Does not abbreviate number "Two".

12NO: Abbreviates to "N" for "Nine", and "O" for "Zero". Does not abbreviate numbers "One" and "Two".

12NT: Abbreviates to "N" for "Nine", and "T" for "Zero". Does not abbreviate numbers "One" and "Two".

CONTEST NUMBER

Function: Enters the initial contest number that will increment/decrement each time the CW message is sent during contest QSOs.

Available Values: 1 - 9999

Default Setting: 1

CW MEMORY 1

Function: Selects the registration method for the contest keyer "CW MEMORY 1".

Available Values: TEXT / MESSAGE

Default Setting: TEXT

Description:

TEXT: Use the optional FH-2 or the touch panel to enter text (page 53).

MESSAGE: Use the keyer to register text to the contest memory keyer (page 51).

CW MEMORY 2

Function: Selects the registration method for the contest keyer "CW MEMORY 2".

Available Values: TEXT / MESSAGE

Default Setting: TEXT

Description:

TEXT: Use the optional FH-2 or the touch panel to enter text (page 53).

MESSAGE: Use the keyer to register text to the contest memory keyer (page 51).

CW MEMORY 3

Function: Selects the registration method for the contest keyer "CW MEMORY 3".

Available Values: TEXT / MESSAGE

Default Setting: TEXT

Description:

TEXT: Use the optional FH-2 or the touch panel to enter text (page 53).

MESSAGE: Use the keyer to register text to the contest memory keyer (page 51).

CW MEMORY 4

Function: Selects the registration method for the contest keyer "CW MEMORY 4".

Available Values: TEXT / MESSAGE

Default Setting: TEXT

Description:

TEXT: Use the optional FH-2 or the touch panel to enter text (page 53).

MESSAGE: Use the keyer to register text to the contest memory keyer (page 51).

CW MEMORY 5

Function: Selects the registration method for the contest keyer "CW MEMORY 5".

Available Values: TEXT / MESSAGE

Default Setting: TEXT

Description:

TEXT: Use the optional FH-2 or the touch panel to enter text (page 53).

MESSAGE: Use the keyer to register text to the contest memory keyer (page 51).

REPEAT INTERVAL

Function: Sets the interval time between each repetition of the beacon message.

Available Values: 1 - 60 (sec)

Default Setting: 5 sec

Description: Set the interval for transmitting the CW code registered in the contest memory keyer as a beacon.

On the "CW MESSAGE MEMORY" screen, press and hold the number registered with the code to be sent. The CW Morse code message will be transmitted at the set intervals.

OPERATION SETTING - GENERAL -

BEEP LEVEL

Function: Sets the beep volume level.

Available Values: 0 - 100

Default Setting: 20

Description: The higher the setting, the louder the sound becomes.

RF/SQL VR

Function: Selects the operation mode of the RF/SQL knob.

Available Values: RF / SQL / SQL(FM only)

Default Setting: RF

Description:

RF: Functions as the RF gain adjustment knob.

SQL: Functions as the Squelch level adjustment knob.

SQL(FM only):

Functions as the squelch level adjustment knob in FM, FM-N, DATA-FM and D-FM-N modes, and as the RF gain adjustment knob in other modes.

TUN/LIN PORT SELECT

Function: Selects the function of the TUNER/LINEAR terminal.

Available Values: EXT-TUNER / LINEAR / CAT-3 / GP OUT

Default Setting: EXT-TUNER

Description: Select the antenna tuner to be used.

EXT-TUNER:

Select this item when using the external antenna tuner (the optional FC-40, etc.).

LINEAR: Select this item when using a Linear Amplifier.

CAT-3: Select this item when used as a CAT terminal.

GP OUT: H/L signal is output by CAT command "GP".

TUNER TYPE SELECT

Function: Internal and external antenna tuner settings.

Available Values: INT / INT(FAST) / EXT / ATAS

Default Setting: INT

Description: Select the antenna tuner to be used.

INT: Select this item when using the internal antenna tuner. (An external antenna tuner cannot be used.)

INT(FAST):

Select this item when using the internal antenna tuner. Tuning is performed at a higher speed than normal, although accuracy is slightly reduced. (An external antenna tuner cannot be used.)

EXT: Select this item when using an external antenna tuner (the optional FC-40, etc.).

ATAS: Select this item when using the active tuning antenna system ATAS-120A.

CAT-1 RATE

Function: Sets the baud rate for a CAT command input of the USB jack (Enhanced COM Port).

Available Values: 4800 / 9600 / 19200 / 38400 / 115200 bps

Default Setting: 38400 bps

CAT-1 TIME OUT TIMER

Function: Sets the Time-Out Timer for a CAT command input.

Available Values: 10 / 100 / 1000 / 3000 (msec)

Default Setting: 10 msec

Description: Sets the Time-Out Timer countdown time for a CAT command input of the USB jack (Enhanced COM Port).

CAT-1 CAT-3 STOP BIT

Function: Stop bit setting when operating with CAT-1 and CAT-3. The stop bit of CAT-2 is "1bit" and cannot be "2bit".

Available Values: 1bit / 2bit

Default Setting: 1bit

CAT-2 RATE

Function: Sets the baud rate for a CAT-2 command input of the USB jack (Standard COM Port).

Available Values: 4800 / 9600 / 19200 / 38400 / 115200 bps

Default Setting: 4800 bps

CAT-2 TIME OUT TIMER

Function: Sets the Time-Out Timer for a CAT-2 command input.

Available Values: 10 / 100 / 1000 / 3000 (msec)

Default Setting: 10 msec

Description: Sets the Time-Out Timer countdown time for a CAT-2 command input of the USB jack (Standard COM Port).

CAT-3 RATE

Function: Sets the baud rate for a CAT-3 command input of the TUNER/LINEAR jack.

Available Values: 4800 / 9600 / 19200 / 38400 / 115200 bps

Default Setting: 38400 bps

CAT-3 TIME OUT TIMER

Function: Sets the Time-Out Timer for a CAT-3 command input.

Available Values: 10 / 100 / 1000 / 3000 (msec)

Default Setting: 10 msec

Description: Sets the Time-Out Timer countdown time for a CAT-3 command input of the TUNER/LINEAR jack.

QMB CH

Function: Number of channels setting of the Quick Memory bank.

Available Values: 5ch / 10ch

Default Setting: 5ch

Description: Set the number of channels that can be registered in the Quick Memory Bank.

BAND STACK

Function: Enable/Disable the band stack function.

Available Values: OFF / ON

Default Setting: ON

Description:

ON: Enable the band stack function.

OFF: Disable the band stack function.

MEM GROUP

Function: Sets the memory group function.

Available Values: OFF / ON

Default Setting: OFF

Description: Set this setting to "ON" to divide the memory channels into 6 groups.

TX TIME OUT TIMER

Function: Sets the Time-Out Timer countdown time.

Available Values: OFF / 1 - 30 min

Default Setting: OFF (10 min, European Version)

Description: When the time-out timer function is active, a beep is emitted when a continuous transmission nears the set time. About 10 seconds later, the transceiver is forced to return to the receiving mode.

MIC SCAN

Function: Activates the microphone automatic scanning function.

Available Values: OFF / ON

Default Setting: ON

Description: Sets the operation of the UP/DWN keys on the microphone.

ON: Starts scanning automatically by pressing and holding the UP/DWN key for 1 second or more (Scanning continues even after releasing the button). To stop scanning, press the UP/DWN key again briefly or press the PTT button to transmit.

OFF: Scans only while pressing and holding the UP/DWN key. To stop scanning, release the button.

MIC SCAN RESUME

Function: Sets the Scan Resume function.

Available Values: PAUSE / TIME

Default Setting: TIME

Description:

PAUSE: During automatic scanning, the scanner will hold until the signal disappears.

TIME: If the signal does not disappear within five seconds, the scanner will resume scanning for the next active channel (frequency).

If there are no signals, the scanner continues scanning.

REF FREQ FINE ADJ

Function: Adjusts the reference oscillator.

Available Values: -25 - 0 - 25

Default Setting: 0

Description: The frequency may be calibrated by connecting a frequency counter to the transceiver, or by receiving a standard frequency such as WWV or WWVH.

KEYBOARD LANGUAGE

Function: Selects the keyboard language.

Available Values: JAPANESE / ENGLISH(US)

ENGLISH(UK) / FRENCH

FRENCH(CA) / GERMAN

PORTUGUESE

PORTUGUESE(BR)

SPANISH / SPANISH(LATAM)

ITALIAN

Default Setting: Depends on the transceiver version.

MIC P1 / P2 / P3 / P4

Function: The functions of the [P1] / [P2] / [P3] / [P4] keys can be assigned the other functions.

Available Values: LOCK / QMB / A/B / V/M / TUNER / VOX/MOX / MODE / ZIN_SPOT / SPLIT / FINE / NAR / NB / DNR / FREQ UP / FREQ DOWN / BAND UP / BAND DOWN / ATT / IPO / DNF / AGC

Default Setting: MIC P1: LOCK

MIC P2: QMB

MIC P3: A/B

MIC P4: V/M

Description:

LOCK: Toggles the ON/OFF lock for the MAIN Dial knob.

QMB: QMB (Quick Memory Bank) function.

A/B: Swaps the VFO-A and VFO-B frequency data.

V/M: Toggles frequency control between VFO and the memory system.

TUNER: Turns the built-in antenna tuner ON/OFF.

VOX/MOX: Press to turn the VOX function ON/OFF. Press and hold to activate the MOX function.

MODE: Change the operation mode.

ZIN SPOT: Press to activate the auto-zero function. Press and hold to activate the sidetone.

SPLIT: SPLIT function.

FINE: Sets the fine tuning ON/OFF.

NAR: Sets the Narrow ON/OFF.

NB: Activates the NB (Noise blanker) function.

DNR: Activates the DNR (Digital Noise Reduction) function.

FREQ UP: Change to a higher frequency.

FREQ DOWN: Change to a Lower frequency.

BAND UP: Change to a higher Operation Band.

BAND DOWN: Change to a Lower Operation Band.

ATT: Turns the ATT (Attenuator) ON/OFF.

IPO: Activates the IPO.

DNF: Turns the DNF (Digital Notch Filter) ON/OFF.

AGC: Adjust the AGC receiver-recovery time.

MIC UP / MIC DOWN

Function: The functions of the [UP] / [DWN] keys of the supplied microphone can be assigned the other functions.

Available Values: Same as MIC P1 to MIC P4 on the left.

Default Setting: UP: FREQ UP

DWN: FREQ DOWN

Description: Same as MIC P1 to MIC P4 on the left.

SCU-LAN10

Function: Selects the use of the LAN unit "SCU-LAN10".

Available Values: OFF / ON

Default Setting: ON

Description:

ON: When using the SCU-LAN10.

OFF: When not using the SCU-LAN10.

OPERATION SETTING - RX DSP -

IF NOTCH WIDTH

Function: Sets the attenuation bandwidth characteristic of the DSP IF notch filter.

Available Values: NARROW / WIDE

Default Setting: WIDE

Description: Sets the attenuation bandwidth characteristic setting of the DSP IF notch filter to "NARROW" or "WIDE".

NB REJECTION

Function: Selects the level of noise attenuation.

Available Values: LOW / MID / HIGH

Default Setting: MID

NB WIDTH

Function: Sets the duration of the noise blanking pulse to match various types of noise compatible with the noise blanker function.

Available Values: NARROW / MEDIUM / WIDE

Default Setting: MEDIUM

Description: Reduces long duration noise as well as pulse noise by changing the setting.

APF WIDTH

Function: Sets the bandwidth of the Audio Peak Filter.

Available Values: NARROW / MEDIUM / WIDE

Default Setting: MEDIUM

Description: In CW mode the APF peak center frequency is set according to the CW PITCH frequency and the chosen APF bandwidth value. In order to listen to the desired signal comfortably, select one of the three bandwidths of the peak filter.

CONTOUR LEVEL

Function: Adjusts the GAIN of the CONTOUR circuit.

Available Values: -40 - 0 - 20

Default Setting: -15

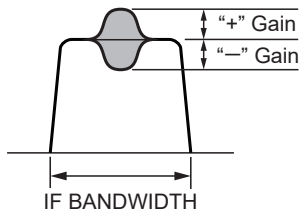

CONTOUR WIDTH

Function: Sets the bandwidth ("Q") of the CONTOUR circuit.

Available Values: 1 - 11

Default Setting: 10

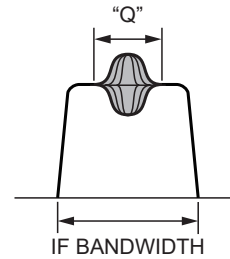

OPERATION SETTING

- TX AUDIO -

AMC RELEASE TIME

Function: AMC level adjustment tracking speed setting

Available Values: FAST / MID / SLOW

Default Setting: MID

Description: Set the input audio level tracking speed of the AMC function.

PRMTRC EQ1 FREQ

Function: Sets the center frequency of the low range for the 3 band parametric microphone equalizer.

Available Values: OFF / 100 - 700 (Hz)

Default Setting: OFF

Description: Selects the center frequency setting of the low range of the 3 Band Parametric Microphone Equalizer in 100Hz steps between "100Hz" and "700Hz".

PRMTRC EQ1 LEVEL

Function: Sets the gain for the low range of the 3 Band Parametric Microphone Equalizer.

Available Values: -20 - 0 - 10 (dB)

Default Setting: 5

Description: Selects the gain setting for the low range of the 3 Band Parametric Microphone Equalizer between "-20 dB" and "+10 dB".

PRMTRC EQ1 BWTH

Function: Sets the width ("Q") for the low range of the 3 Band Parametric Microphone Equalizer.

Available Values: 0 - 10

Default Setting: 10

Description: Selects the width (Q) setting for the low range for the 3 Band Parametric Microphone Equalizer between "0" and "10".

PRMTRC EQ2 FREQ

Function: Sets the center frequency for the middle range of the 3 Band Parametric Microphone Equalizer.

Available Values: OFF / 700 - 1500 (Hz)

Default Setting: OFF

Description: Selects the center frequency setting for the middle range of the 3 Band Parametric Microphone Equalizer in 100Hz steps between "700Hz" and "1500Hz".

PRMTRC EQ2 LEVEL

Function: Sets the gain for the middle range of the 3 Band Parametric Microphone Equalizer.

Available Values: -20 - 0 - 10 (dB)

Default Setting: 5

Description: Selects the gain setting for the middle range of the 3 Band Parametric Microphone Equalizer between "-20 dB" and "+10 dB".

PRMTRC EQ2 BWTH

Function: Sets the width ("Q") for the middle range of the 3 Band Parametric Microphone Equalizer.

Available Values: 0 - 10

Default Setting: 10

Description: Selects the width ("Q") setting for the middle range of the 3 Band Parametric Microphone Equalizer between "0" and "10".

PRMTRC EQ3 FREQ

Function: Sets the center frequency for the high range of the 3 Band Parametric Microphone Equalizer.

Available Values: OFF / 1500 - 3200 (Hz)

Default Setting: OFF

Description: Selects the center frequency setting for the high range of the 3 Band Parametric Microphone Equalizer in 100Hz steps between "1500Hz" and "3200Hz".

PRMTRC EQ3 LEVEL

Function: Sets the gain for the high range of the 3 Band Parametric Microphone Equalizer.

Available Values: -20 - 0 - 10 (dB)

Default Setting: 5

Description: Selects the gain setting for the high range of the 3 Band Parametric Microphone Equalizer between "-20 dB" and "+10 dB".

PRMTRC EQ3 BWTH

Function: Sets the width ("Q") for the high range of the 3 Band Parametric Microphone Equalizer.

Available Values: 0 - 10

Default Setting: 10

Description: Selects the width ("Q") setting for the high range of the 3 Band Parametric Microphone Equalizer between "0" and "10".

P PRMTRC EQ1 FREQ

Function: Sets the center frequency of the low range for the 3 Band Parametric Microphone Equalizer when the Speech Processor is activated.

Available Values: OFF / 100 - 700 (Hz)

Default Setting: OFF

Description: Activates when the Speech Processor is "ON", and selects the center frequency setting for the low range of the 3 Band Parametric Microphone Equalizer in 100Hz steps between "100Hz" and "700Hz".

P PRMTRC EQ1 LEVEL

Function: Sets the gain for the low range of the 3 Band Parametric Microphone Equalizer when the Speech Processor is activated.

Available Values: -20 - 0 - 10 (dB)

Default Setting: 0

Description: Activates when the Speech Processor is "ON" and selects the gain setting for the low range of the 3 Band Parametric Microphone Equalizer between "-20 dB" and "+10 dB".

P PRMTRC EQ1 BWTH

Function: Sets the width ("Q") for the low range of the 3 Band Parametric Microphone Equalizer when the Speech Processor is activated.

Available Values: 0 - 10

Default Setting: 2

Description: Activates when the Speech Processor is "ON", and selects the width ("Q") setting for the low range of the 3 Band Parametric Microphone Equalizer between "0" and "10".

P PRMTRC EQ2 FREQ

Function: Sets the center frequency for the middle range of the 3 Band Parametric Microphone Equalizer when the Speech Processor is activated.

Available Values: OFF / 700 - 1500 (Hz)

Default Setting: OFF

Description: Activates when the Speech Processor is "ON", and selects the center frequency setting for the middle range of the 3 Band Parametric Microphone Equalizer in 100Hz steps between "700Hz" and "1500Hz".

P PRMTRC EQ2 LEVEL

Function: Sets the gain for the middle range of the 3 Band Parametric Microphone Equalizer when the Speech Processor is activated.

Available Values: -20 - 0 - 10 (dB)

Default Setting: 0

Description: Activates when the Speech Processor is "ON", and selects the gain setting for the middle range of the 3 Band Parametric Microphone Equalizer between "-20 dB" and "+10 dB".

P PRMTRC EQ2 BWTH

Function: Sets the width ("Q") for the middle range of the 3 Band Parametric Microphone Equalizer when the Speech Processor is activated.

Available Values: 0 - 10

Default Setting: 1

Description: Activates when the Speech Processor is "ON", and selects the width ("Q") setting for the middle range of the 3 Band Parametric Microphone Equalizer between "0" and "10".

P PRMTRC EQ3 FREQ

Function: Sets the center frequency for the high range of the 3 Band Parametric Microphone Equalizer when the Speech Processor is activated.

Available Values: OFF/1500 - 3200 (Hz)

Default Setting: OFF

Description: Activates when the Speech Processor is "ON", and selects the center frequency setting for the high range of the 3 Band Parametric Microphone Equalizer in 100Hz steps between "1500Hz" and "3200Hz".

P PRMTRC EQ3 LEVEL

Function: Sets the gain for the high range of the 3 Band Parametric Microphone Equalizer when the Speech Processor is activated.

Available Values: -20 - 0 - 10 (dB)

Default Setting: 0

Description: Activates when the Speech Processor is "ON", and selects the gain setting for the high range of the 3 Band Parametric Microphone Equalizer between "-20 dB" and "+10 dB".

P PRMTRC EQ3 BWTH

Function: Sets the width ("Q") for the high range of the 3 Band Parametric Microphone Equalizer when the Speech Processor is activated.

Available Values: 0 - 10

Default Setting: 1

Description: Activates when the Speech Processor is "ON", and selects the width ("Q") setting for the high range of the 3 Band Parametric Microphone Equalizer between "0" and "10".

OPERATION SETTING - TX GENERAL -

HF MAX POWER

Function: Sets the transmit RF power output of the HF band.

Available Values: 5 - 100W

Default Setting: 100W

50M MAX POWER

Function: Sets the transmit RF power output of the 50 MHz band.

Available Values: 5 - 100W

Default Setting: 100W

70M MAX POWER

Function: Sets the transmit RF power output of the 70 MHz band.

Available Values: 5 - 50W

Default Setting: 50W

AM MAX POWER

Function: Sets the transmit RF power output of the AM mode.

Available Values: 5 - 25W

Default Setting: 25W

VOX SELECT

Function: Selects the function of the VOX operation.

Available Values: MIC / USB / REAR

Default Setting: MIC

Description:

MIC: Operates via input from the MIC jack (microphone).

USB: Operates via input from the USB jack.

REAR: Operates via input from the RTTY/DATA jack.

EMERGENCY FREQ TX

Function: Enables TX/RX operation on the Alaska Emergency Channel, 5167.5kHz.

Available Values: OFF / ON

Default Setting: OFF

Description: When this Menu Item is set to "ON", the spot frequency of 5167.5 kHz will be enabled. The Alaska Emergency Channel will be found between the PMS memory channel "M-P9U (or 5-10)" and the memory channel "M-01".

Important: The use of this frequency is restricted to stations operating in or near Alaska, and only for emergency purposes (never for routine operations). See §97.401(c) of the FCC regulations.

TX INHIBIT

Function: Enable/Disable the TX INHIBIT function.

Available Values: OFF / ON

Default Setting: OFF

Description:

ON: Enable the TX INHIBIT function.

OFF: Disable the TX INHIBIT function.

METER DETECTOR

Function: Setting of the PO meter display.

Available Values: AVERAGE / PEAK

Default Setting: AVERAGE

Description: Select the transmit power output indication method.

AVERAGE: Displays the average transmit power. (Even if the transmit power is 100W, the meter rarely swings to 100W.)

PEAK: Displays the maximum transmit power. (When the transmit output power is 100W, the meter swings up to 100W.)

OPERATION SETTING - TUNING -

SSB/CW DIAL STEP

Function: Setting of the MAIN dial tuning speed in the SSB and CW mode.

Available Values: 5 / 10 / 20 (Hz)

Default Setting: 20Hz

RTTY/PSK DIAL STEP

Function: Setting of the Main dial knob tuning speed in the RTTY and PSK mode.

Available Values: 5 / 10 / 20 (Hz)

Default Setting: 10Hz

CH STEP

Function: Selects the tuning steps for the Main dial knob.

Available Values: 1 / 2.5 / 5 / 10 (kHz)

Default Setting: 5kHz

AM CH STEP

Function: Selects the tuning steps for the Main dial knob in the AM mode.

Available Values: 2.5 / 5 / 9 / 10 / 12.5 / 25 (kHz)

Default Setting: 5kHz

FM CH STEP

Function: Selects the tuning steps for the Main dial knob in the FM mode.

Available Values: 5 / 6.25 / 10 / 12.5 / 20 / 25 (kHz)

Default Setting: 5kHz

MAIN STEPS PER REV.

Function: Setting the steps per rotation of the MAIN dial.

Available Values: 50 / 100 / 200

Default Setting: 200

DISPLAY SETTING - DISPLAY -

MY CALL

Function: Programs a Call Sign or Name.

Available Values: Up to 12 alphanumeric characters

Default Setting: FT-710

Description: Set characters to be displayed on the power ON opening screen.

MY CALL TIME

Function: Set the time for displaying characters registered in "MY CALL".

Available Values: OFF / 1 / 2 / 3 / 4 / 5 (sec)

Default Setting: 1sec

Description: Set the time "My Call is displayed on the opening screen after power ON.

POP-UP TIME

Function: Sets the display time of the pop-up screen when setting various functions

Available Values: FAST / MID / SLOW

Default Setting: MID

Description:

FAST: Pop-up screen display time is shorter than normal.

MID: Pop-up screen display time is normal.

SLOW: Pop-up screen display time is longer than normal.

SCREEN SAVER

Function: Time setting before the screen saver to activate.

Available Values: OFF / 15 / 30 / 60 (min)

Default Setting: 60min

Description: If the transceiver is not operated for the set time, a screen saver will activate to prevent TFT screen burns.

LED DIMMER

Function: Sets the key LED brightness level.

Available Values: OFF / 1 - 20

Default Setting: 20

Description: The higher the setting, the brighter the illumination becomes.

Note: the power switch, [VOX/MOX], and the BUSY/TX LEDs will remain ON, even when the brightness level is set to OFF.

MOUSE POINTER SPEED

Function: Mouse pointer movement speed setting.

Available Values: 0 - 20

Default Setting: 10

Description: The higher the setting, the faster the Mouse pointer will move.

DISPLAY SETTING - SCOPE -

RBW

Function: Sets the resolution of Spectrum Scope display.

Available Values: HIGH / MID / LOW

Default Setting: HIGH

Description: When set to HIGH, the image is finely divided.

SCOPE CTR

Function: Sets the scope screen center and marker position.

Available Values: FILTER / CARRIER

Default Setting: CARRIER

Description:

FILTER: Relative to the center of the filter.

CAR POINT: Based on signal carrier points.

2D DISP SENSITIVITY

Function: Change the Waterfall Display sensitivity.

Available Values: NORMAL / HI

Default Setting: HI

Description:

NORMAL: Display at normal sensitivity.

HI: Display at high sensitivity.

3DSS DISP SENSITIVITY

Function: Change the 3DSS Display sensitivity.

Available Values: NORMAL / HI

Default Setting: HI

Description:

NORMAL: Display at normal sensitivity.

HI: Display at high sensitivity.

DISPLAY SETTING - VFO IND COLOR -

VMI COLOR VFO-A

Function: Sets the color of VMI (VFO mode indicator) when operating on VFO-A.

Available Values: BLUE / GREEN / RED / NONE
Default Setting: BLUE

VMI COLOR VFO-B

Function: Sets the color of VMI (VFO mode indicator) when operating on VFO-B.

Available Values: BLUE / GREEN / RED / NONE
Default Setting: GREEN

VMI COLOR MEMORY

Function: Sets the color of VMI (VFO mode indicator) when operating in memory mode.

Available Values: BLUE / GREEN / WHITE / NONE

Default Setting: WHITE

VMI COLOR CLAR

Function: Sets the color of VMI (VFO mode indicator) when operating in Clarifier / Split function.

Available Values: RED / NONE
Default Setting: RED

DISPLAY SETTING - EXT MONITOR -

EXT DISPLAY

Function: Video signal output setting of the EXT-DISPLAY terminal on the rear panel.

Available Values: OFF / ON
Default Setting: OFF

Description:

OFF: No video signal output.

ON: Video signal is output.

PIXEL

Function: Select the screen resolution of the external video monitor.

Available Values: 800x480 / 800x600
Default Setting: 800x480

EXTENSION SETTING - DATE & TIME -

DAY

Set the date (Day).

MONTH

Set the date (Month).

YEAR

Set the date (Year).

HOUR

Set the time (Hour).
Set to 24-hour format.

MINUTE

Set the time (Minute).

EXTENSION SETTING - SD CARD -

MEM LIST LOAD

Function: Load the Memory Channel information saved on the SD memory card into the transceiver.

MEM LIST SAVE

Function: Save the Memory Channel information to the SD memory card.

MENU LOAD

Function: Load the Setting Menu information saved on the SD memory card into the transceiver.

MENU SAVE

Function: Save the Setting Menu information to the SD memory card.

INFORMATIONS

Function: Display information from SD Memory Card.

Description: Displays the total capacity and free space of the SD Memory Card.

FIRMWARE UPDATE

Function: Update the firmware of the FT-710.

Description: When a new firmware update for the FT-710 is available, go to the YAESU web site to download the programming data and update the FT-710 Firmware.

FORMAT

Function: Format (initialize) the SD memory card.

Description: Format a micro SD Memory Card for use with this transceiver.

EXTENSION SETTING - SOFT VERSION -

Description: Displays the software version.

EXTENSION SETTING - CALIBRATION -

CALIBRATION

Function: Display touch position calibration.

Description: If the touch position and the operation are different, that is touch does not work or another function works, perform touch position calibration of the TFT display.

1. Select [CALIBRATION] then press the [FUNC] knob.
2. Touch [DONE].
3. Touch "+" at the top left of the display.
4. Touch "+" displayed at another place.
5. Repeat step 3 and finally touch "+" in the center of the display to complete the calibration.

EXTENSION SETTING - RESET -

MEMORY CLEAR

Function: Memory reset

Description: Only the information stored in the Memory Channel is initialized (all erased).



The contents of the memory channel "M-01" will return to the initial setting "7.000.000 MHz, LSB" and cannot be deleted.



Memory information can be saved on the SD card.

MENU CLEAR

Function: Setting Menu reset

Description: Only the contents of the Setting Menu is initialized (factory default).



Information in the setting menu can be saved on the SD card.

ALL RESET

Function: ALL reset

Description: The Memory, Setting Menu and all other settings are initialized and set to the factory default.

Optional Accessories

FC-40 External Automatic Antenna Tuner (for Wire Antenna)

The FC-40 makes use of the control circuitry built into the transceiver, which allows the operator to control and monitor automatic operation of the FC-40, which mounts near the antenna feedpoint. The FC-40 uses specially selected, thermally stable components, and is housed in a waterproof case to withstand severe environmental conditions with high reliability.

A carefully-chosen combination of solid-state switching components and high-speed relays allows the FC-40 to match a wide variety of antennas to within a 2:1 SWR on any amateur band frequency (160 through 6 meters), typically in less than eight seconds. Transmitter power required for matching may be as little as 4 - 60 Watts, and matching settings are automatically stored in memory for instant recall when the same frequency range is selected later.

Please see the FC-40 Operating Manual for detailed information.



Depending on the installation and location of some antennas, it may not be possible to tune to a low SWR.

• Interconnections to FT-710

After mounting the FC-40, connect the cables from the FC-40 to the ANT and TUNER jacks on the rear panel of the FT-710 Transceiver.



Turn OFF the external power supply switch and the FT-710 power supply switch first before connecting the cables.

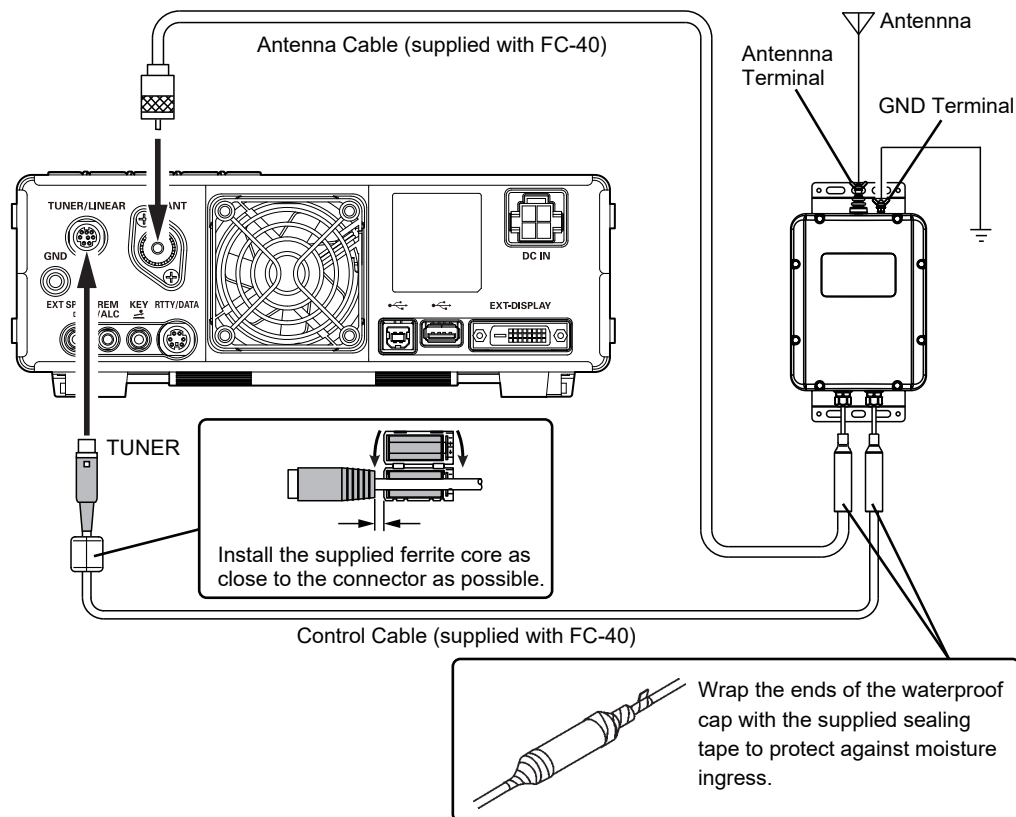

• Setup the transceiver

The optional FC-40 Automatic Antenna Tuner provides automatic tuning of a coaxial line to present nominal 50-ohm impedance to the FT-710's ANT jack.

Before tuning can begin, the FT-710 must be configured to recognize that the FC-40 is being used. Configuration is done using the Setting Menu Mode:

1. Press the [FUNC] knob.
2. Select [OPERATION SETTING] → [GENERAL] → [TUNER TYPE SELECT].
3. Rotate the [FUNC] knob, or touch "<" or ">" on either side of the value to select "EXT".
4. Press the [FUNC] knob, or wait for about 3 seconds to save the setting.
5. Touch [BACK] several times to return to normal operation.

• Tuning Operation

1. Press the [TUNE] key.
A "TUNE" icon will appear in the display; and the tuner function is activated.

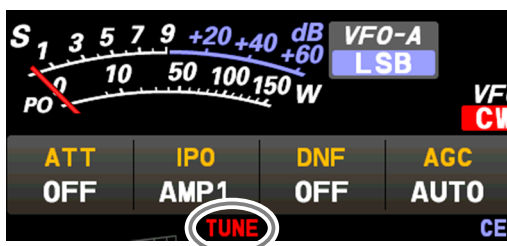
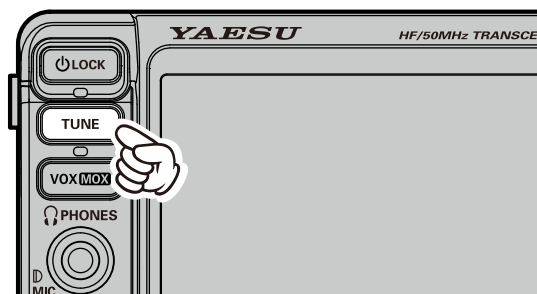

2. Press and hold the [TUNE] key to begin automatic tuning.
 - The transmitter will be engaged, and the "TUNER" icon will blink while tuning is in progress.
 - When the optimum tuning point has been reached, the transceiver will return to receive, and the "TUNER" icon will again glow steadily (instead of blinking).

- Be sure to connect a good earth ground to the GND terminal of the FC-40.
- The carrier signal transmits continuously while tuning is in progress. Please monitor the operating frequency before beginning the tuning process. Be sure you are not interfering with others who may already be using the frequency.
- It is normal to hear the sound of the relays while tuning is in progress.
- If the impedance cannot be matched by the FC-40 better than 2:1, and the "HI-SWR" icon blinks, the microprocessor will not retain the tuning data for that frequency, as the FC-40 presumes that you will want to adjust or repair the antenna system to correct the high SWR condition.

Active-Tuning Antenna System (ATAS-120A)

ATAS-120A is a multi-band auto-tuning antenna that can be used in the amateur bands from the HF band to the UHF band (7/14/21/28(29)/50/144/430). Using the active tuning mechanism, tuning can be carried out automatically by the control signal from FT-710. Please refer to the ATAS-120A Operating Manual for the assembly and installation of ATAS-120A.



Depending on the installation and location of some antennas, it may not be possible to tune to a low SWR.

• Interconnections to FT-710

Connect “ATAS-120A” to the ANT terminal of the FT-710 with a coaxial cable as shown in the diagram below.

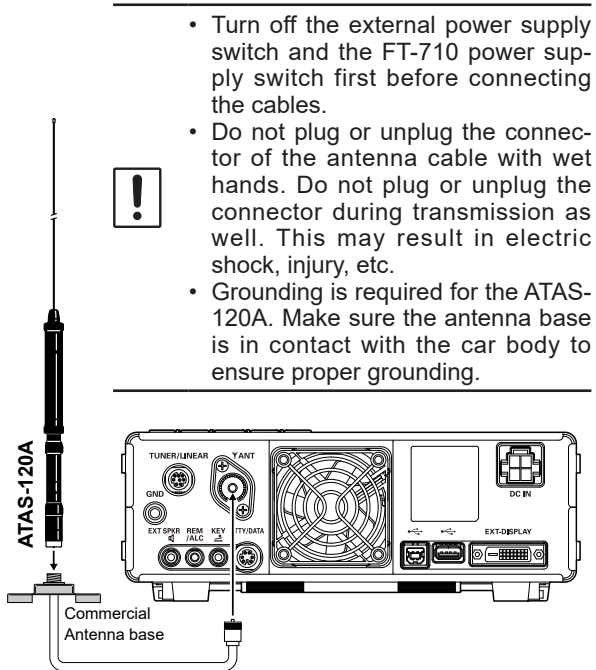

• Setup the transceiver

Before tuning can begin, the FT-710 must be configured to recognize that the ATAS-120A is being used.

Configuration is done using the Setting Menu Mode:

1. Press the [FUNC] knob.
2. Select [OPERATION SETTING] → [GENERAL] → [TUNER TYPE SELECT].
3. Rotate the [FUNC] knob, or touch “<” or “>” on either side of the value to select “ATAS”.
4. Press the [FUNC] knob, or wait for about 3 seconds to save the setting.
5. Touch [BACK] several times to return to normal operation.

The “ATAS” icon will appear in the display.

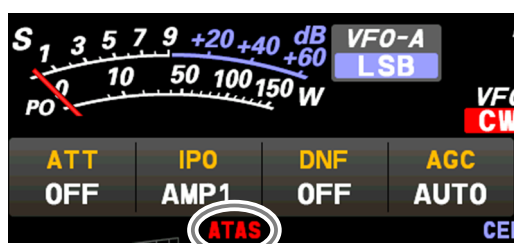

• Tuning Operation

The tuning of the ATAS-120A is carried out automatically.

When using the **ATAS-120A** for the first time or when tuning for the first time after resetting the FT-710, tuning is not performed for about 1 minute until the FT-710 recognizes the **ATAS-120A** even if the [TUNE] key is pressed. Tuning is performed after recognizing the **ATAS-120A**.

Press the [TUNE] key to begin automatic tuning.

- The transmitter will be engaged, and the “ATAS” icon will blink while tuning is in progress.
- When the optimum tuning point has been reached, the transceiver will return to receive, and the “ATAS” icon will again glow steadily (instead of blinking).

- The carrier signal transmits continuously while tuning is in progress. Please monitor the operating frequency before beginning the tuning process. Be sure you are not interfering with others who may already be using the frequency.
- Check the grounding and installation conditions if “HI-SWR” icon blinks (tuning cannot be carried out).

• Manual Tuning

The tuning of the ATAS-120A may be carried out manually.

Press the PTT switch on the microphone to transmit and then press the UP/DWN button on the microphone to adjust the antenna until the meter indicates the minimum SWR.

The meter on the screen will automatically change to the SWR meter.

FH-2 Remote Control Switches

With the optional remote-control keypad FH-2 voice messages may be recorded and transmitted (Voice Memory). The FH-2 is also the control of the Contest Memory Keyer during CW operation.

- SSB / AM / FM modes have five voice memory channels (90 seconds each) for storage and playback, of voice recordings.
- The CW Memory Keyer has 5 channels each for the MESSAGE Memory and the TEXT Memory.

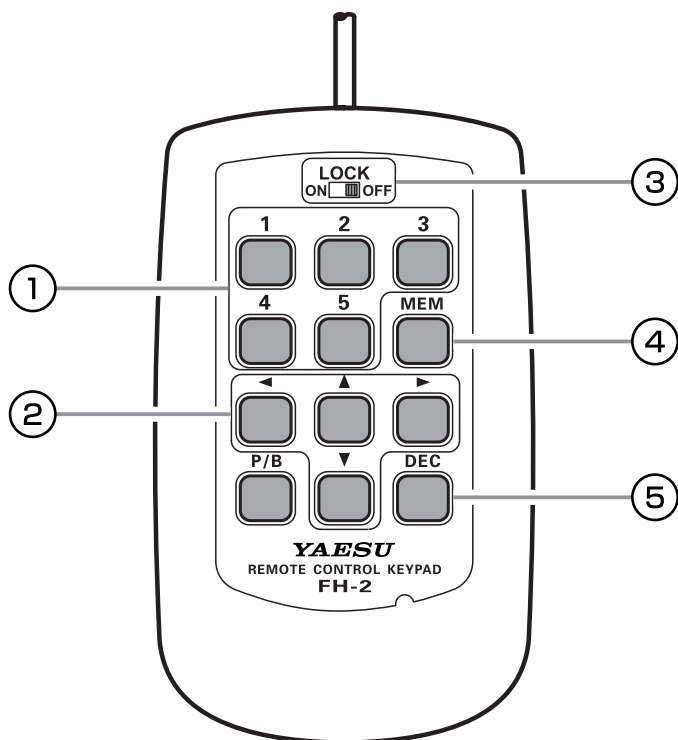

① Voice Memory: 5 Memory Channels for the Memory Keyer

In the case of Voice Memory, up to 90 seconds of audio may be stored on each channel.

“MESSAGE Memory” and “TEXT Memory” are available for the Contest Memory Keyer.

Each “MESSAGE Memory” channel is capable of retaining a 50-character CW message using the PARIS standard for characters and word length.

Each “TEXT Memory” channel is capable of retaining a maximum of 50 characters.

② Cursor Keys

When programming the Contest Memory Keyer, these keys are used to move the cursor and select the text characters.

The cursor may be moved in 4 different directions (up/down/right/left).

NOTE: Usually, these keys are used for changing the VFO frequency. Press the [▲]/[▼] keys to change the frequency in the same increments as the microphone [UP]/[DWN] switches. Press the [◀]/[▶] keys to change the frequency by 100 kHz steps.

③ LOCK Switch

The FH-2 key keys may be locked by setting this switch to “ON”.

④ MEM Key

Press this key to store either a Voice Memory, or a Contest Keyer Memory.

⑤ DEC Key

When utilizing the sequential contest number capability of the Contest Keyer, press this key to decrement (decrease) the current Contest Number by one digit (i.e. to back up from #198 to #197, etc.).

*No function is assigned to the [P/B] key.

Carrying Handle MHG-1



- Do not install the supplied MHG-1 Mounting Screws if you are not installing the MHG-1.
- Do not use an improper screw for mounting the MHG-1! An improper screw may cause a “short circuit” to the internal circuitry, causing serious damage.

Screw the Carrying Handle to the FT-710 using the supplied screws.

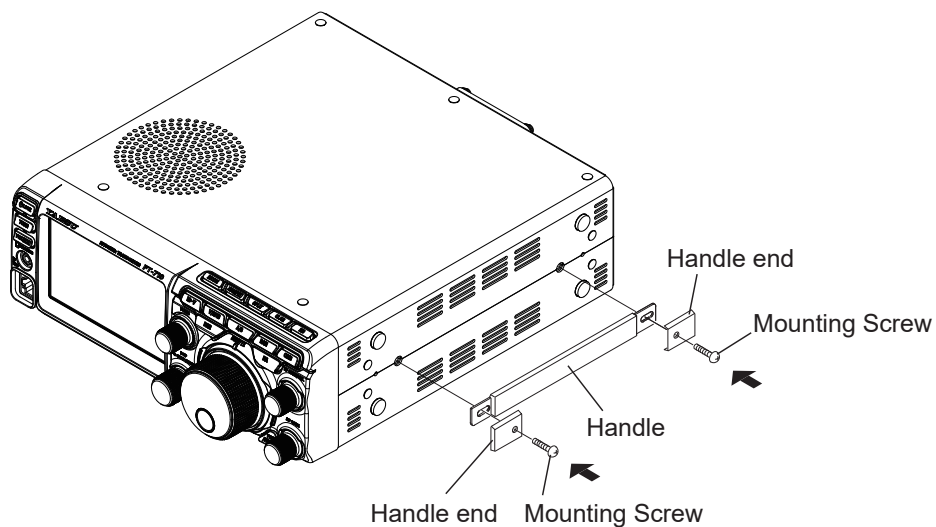

Mounting Bracket SMB-209



- Do not install the supplied SMB-209 Mounting Screws if you are not installing the SMB-209.
- Do not use an improper screw for mounting the SMB-209! An improper screw may cause a “short circuit” to the internal circuitry, causing serious damage.

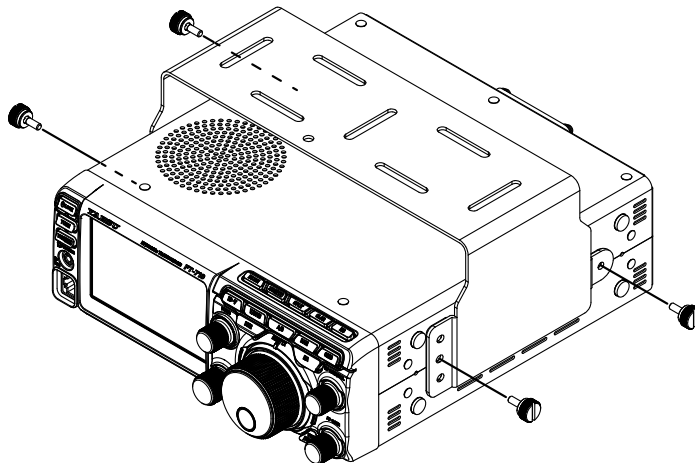

Resetting the Microprocessor

Memory channels, setting menus, and various settings can be initialized and returned to their factory defaults.

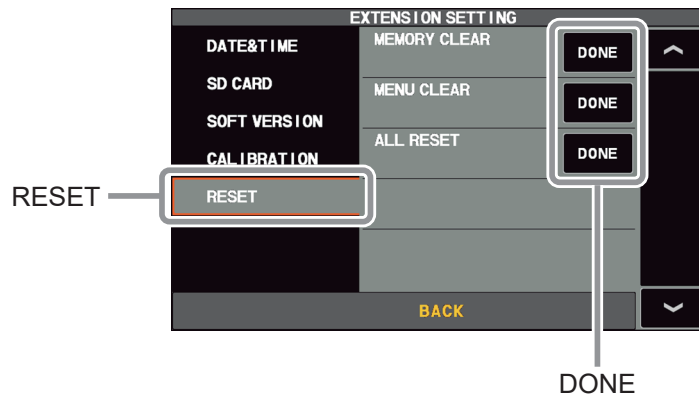
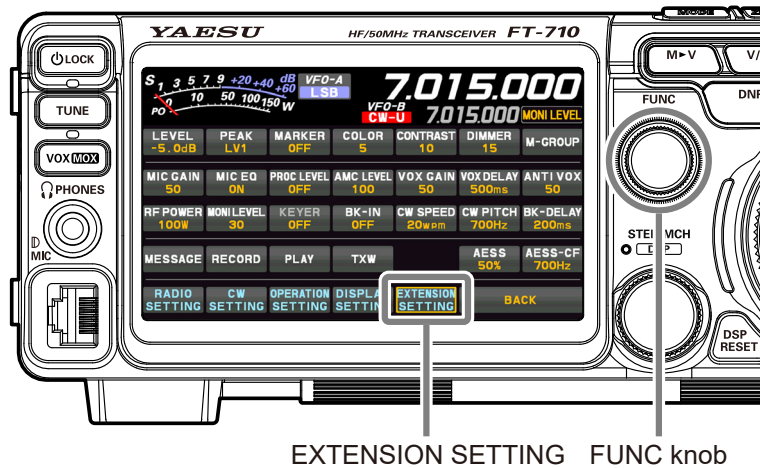

1. Display the reset item selection screen.
Press the [FUNC] knob → touch [EXTENSION SETTING] → touch [RESET]
2. Touch “DONE” of the item you want to reset (see below).
Or Select an item with the [FUNC] knob and press the [FUNC] knob.
A confirmation screen for reset execution is displayed.

MEMORY CLEAR (Memory Reset)

Only the contents of the memory channel are initialized (factory default).

All stored information will be erased, but channel M-01 will return to the initial setting of 7.000.000 MHz, LSB.

MENU CLEAR (Setting Menu Reset)

Only the contents of the setting menu are returned to their default values (factory default).

ALL RESET (All Reset)

Initializes all settings of this unit, including various settings, memories, and setting menus, and restores the factory settings.

3. Touch [OK] or select [OK] with the [FUNC] knob and press the [FUNC] knob to execute the reset.
To cancel the reset, touch [CANCEL] or select [CANCEL] with the [FUNC] knob and press the [FUNC] knob.
4. The power is turned OFF once and then turned ON automatically.
The reset is complete.

Specifications

General

Tx Frequency Range:	1.8MHz - 54MHz (Amateur bands only) 70MHz - 70.5MHz (UK Amateur bands only)
Rx Frequency Range:	30kHz - 75MHz (operating) 1.8MHz - 29.699999MHz (specified performance, Amateur bands only) 50MHz - 53.999999MHz (specified performance, Amateur bands only) 70MHz - 70.499999MHz (specified performance, UK Amateur bands only)
Emission Modes:	A1A (CW), A3E (AM), J3E (LSB, USB), F3E (FM),
Frequency Steps:	1*/5/10/20Hz (CW, SSB, AM), 100Hz (FM) *FINE tuning "ON"
Antenna Impedance:	50Ω, unbalanced (Antenna Tuner "OFF") 16.7 - 150Ω, unbalanced (Tuner "ON", 1.8MHz - 29.7MHz Amateur bands) 25 - 100Ω, unbalanced (Tuner "ON", 50MHz Amateur band)
Operating Temperature Range:	+32°F to +122°F (0°C to +50°C)
Frequency Stability:	±0.5ppm (after 1 minute @ +32°F to +122°F [0°C to +50°C])
Supply Voltage:	DC13.8V ± 15% (Negative Ground)
Power Consumption (approx.)	Rx (no signal) 1.8A Rx (signal present) 2.2A Tx (100W) 21A
Dimensions (WxHxD):	9.4" x 3.1" x 9.7" (239 x 80 x 247mm)
Weight (approx.):	9.92 lbs (4.5kg)

Transmitter

Power Output:	5 - 100W (5 - 25W AM carrier)
Modulation Types:	J3E (SSB): Balanced A3E (AM): Low-Level (Early Stage) F3E (FM): Variable Reactance
Maximum FM Deviation:	±5.0kHz / ±2.5kHz (Narrow)
Harmonic Radiation:	Better than -50dB (1.8MHz - 29.7MHz Amateur bands) Better than -63dB (50MHz Amateur band: 100W)
SSB Carrier Suppression:	At least 60dB below peak output
Undesired Sideband Suppression:	At least 60dB below peak output
Bandwidth:	3kHz (LSB, USB), 500Hz (CW), 6kHz (AM), 16kHz (FM)
Audio Response (SSB):	Not more than -6dB from 300 to 2700Hz
Microphone Impedance:	600Ω (200 to 10kΩ)

Receiver

Circuit Type:	Direct Sampling Superheterodyne		
Intermediate Frequencies:	SSB, CW: 18kHz / AM, FM: 24kHz		
Sensitivity (typ):	SSB/CW (BW: 2.4kHz, 10dB S+N/N)		
	1.8MHz - 30MHz	0.16 μ V (IPO: AMP2)	
	50MHz - 54MHz	0.125 μ V (IPO: AMP2)	
	70MHz - 70.5MHz	0.16 μ V (IPO: AMP2)	
	AM (BW: 6kHz, 10dB S+N/N, 30% modulation @400Hz)		
	0.5MHz - 1.8MHz	6.3 μ V	
	1.8MHz - 30MHz	2 μ V (IPO: AMP2)	
	50MHz - 54MHz	1 μ V (IPO: AMP2)	
	70MHz - 70.5MHz	2 μ V (IPO: AMP2)	
	FM (BW: 12kHz, 12dB SINAD, 3.5kHz DEV @1kHz)		
28MHz - 30MHz	0.25 μ V (IPO: AMP2)		
50MHz - 54MHz	0.2 μ V (IPO: AMP2)		
70MHz - 70.5MHz	0.25 μ V (IPO: AMP2)		
Selectivity (typ):	Mode	-6dB	-60dB
	CW (BW=0.5kHz)	0.5kHz or better	0.75kHz or less
	SSB (BW=2.4kHz)	2.4kHz or better	3.6kHz or less
	AM (BW=6kHz)	6kHz or better	15kHz or less
	FM (BW=12kHz)	12kHz or better	25kHz or less
Image Rejection:	70dB or better (1.8MHz - 28MHz Amateur bands)		
	60dB or better (50MHz Amateur band)		
Maximum Audio Output:	2.5W into 4 Ω with 10% THD		
Audio Output Impedance:	4 to 16 Ω (4 Ω : nominal)		
Conducted Radiation:	Less than 4nW		

Specifications are subject to change, in the interest of technical improvement, without notice or obligation, and are guaranteed only within the amateur bands.

Index

3DSS	23
5 MHz Band	63
60-Meter (5 MHz) Band	63

A

A/B	35
About TFT Displays	28
Accessories	8
Adjustable Receiver Audio Filter	46
Adjust contrast	26
Adjusting the brightness	26
Adjusting the Clock	68
Adjusting the Date	68
Adjusting the Sidetone Audio level	49
AESS	13
AF	37
AGC	21
AMC	40
ANT	14
Antenna Connections	9
Antenna Considerations	9
ATT	21
ATU	48
Automatic Antenna Tuner	48
Automatic Mic Gain Control	40

B

BAND	35
Band Stack Operation	66

C

Carrying Handle	104
CENTER	22
Change the sound quality of the received audio	47
Check Memory Channel Status	62
Clarifier	38
COLOR	26
Contest Memory Keyer	51
Contest Number	54
CURSOR	22
CW Delay Time Setting	49
CW Mode Operation	49

D

DATA Operation	56
DC IN	14
Digital Noise Reduction	35
Display connections	12
Display Indications	16
DNR	35
DWN key	15

E

Electronic Keyer	50
Erasing Memory Channel Data	62
EXPAND	24

EXT-DISPLAY	14
EXT SPKR	14

F

FC-40 External Automatic Antenna Tuner	100
FH-2 Connections	10
FH-2 Remote Control Switches	103
Filter Function Display	20
FIX	23
FM Mode Operation	55
Frequency Display	18
Front Panel Controls & Switches	30
FT8 Operation	57

G

GND	14
-----------	----

H

Headphone Connections	10
HI-SWR Display	17

I

Important Receiver Settings	21
Inputting the Call Sign	27
Installation and Interconnections	9
IPO	21

K

KEY	14
Key and Keyer Connections	10
Keyboard Frequency Entry	18
Keyer Speed	50
Keyer Weight (Dot/Dash) Ratio	50

L

Labeling Memories	62
LEVEL	25
LIMITED WARRANTY	110
Linear Amplifier Interconnections	11
LINER	14

M

MAIN dial	31
MARKER	26
Memory Operation	60
Memory Scanning	64
Meter Display	17
MIC	31
Microphone	15
Microphone Connections	10
Microphone gain	40
MODE	37
MODE Display	17
Monitor	41
Mounting Bracket	104
MULTI	23
MUTE Key	15

N

NAR (Narrow)	36
NB	39

O

ON/OFF Switch	30
Operating Band Selection	35
Operating Mode Selection	37
Options	8
Other Functions	66

P

P1/P2/P3/P4 key	15
Parametric Microphone Equalizer	42
PEAK	25
PHONES Jack	31
Power Cable Connections	9
PSK Operation	58
PTT Switch	15

Q

QMB	35
Quick Memory Bank	35

R

Rear Panel	14
Record the received audio	45
REM	14
Remote operation connection	12
Repeater Operation	55
Resetting the Microprocessor	105
Reversing the Keyer Polarity	50
RF	37
RF Power output control	41
RTTY/DATA	14
RTTY Operation	58
RX Clarifier	38

S

Safety Precautions	6
Scan Skip Setting	63
Scope Display Setting	22
Screen capture	67
Screen Saver	27
SCU-LAN10	12
SD Card	68
SD memory card slot	30
Selecting the Keyer Operating Mode	50
Setting Menu	71
Setting of the Electronic Keyer	50
Setting the Keyer Weight	50
SP-40 connections	13
SPAN	24
Specifications	106
Speech Processor	41
SPEED	24
SPLIT	38
SPOT	38
SQL	37

SSM-75E Microphone Switches	15
-----------------------------------	----

T

Time Out Timer	66
Tone Squelch Operation	55
TOT	66
TUNE	30
TUNER	14
Tuning in 1 MHz or 1 kHz Steps	18
TX Clarifier	39

U

UP key	15
USB	14
USB Jack	14

V

VFO Scanning	64
Voice Communications	40
Voice Memory	44
VOX	30
VOX anti-trip sensitivity	31
VOX Delay Time	30
VOX GAIN	30

Z

ZIN	38
-----------	----

YAESU LIMITED WARRANTY

Limited Warranty is valid only in the country/region where this product was originally purchased.

On-line Warranty Registration:

Thank you for buying YAESU products! We are confident your new radio will serve your needs for many years! Please register your product at www.yaesu.com - Owner's Corner

Warranty Terms:

Subject to the Limitations of the Warranty and the Warranty Procedures described below, YAESU MUSEN hereby warrants this product to be free of defects in materials and workmanship in normal use during the "Warranty Period." (the "Limited Warranty").

Limitations of Warranty:

- A. YAESU MUSEN is not liable for any express warranties except the Limited Warranty described above.
- B. The Limited Warranty is extended only to the original end-use purchaser or the person receiving this product as a gift, and shall not be extended to any other person or transferee.
- C. Unless a different warranty period is stated with this YAESU product, the Warranty Period is three years from the date of retail purchase by the original end-use purchaser.
- D. The Limited Warranty is valid only in the country/region where this product was originally purchased.
- E. During the Warranty Period, YAESU MUSEN will, at its sole option, repair or replace (using new or refurbished replacement parts) any defective parts within a reasonable period of time and free of charge.
- F. The Limited Warranty does not cover shipping cost (including transportation and insurance) from you to us, or any import fees, duties or taxes.
- G. The Limited Warranty does not cover any impairment caused by tampering, misuse, failure to follow instructions supplied with the product, unauthorized modifications, or damage to this product for any reasons, such as: accident; excess moisture; lightning; power surges; connection to improper voltage supply; damage caused by inadequate packing or shipping procedures; loss of, damage to or corruption of stored data; product modification to enable operation in another country/purpose other than the country/purpose for which it was designed, manufactured, approved and/or authorized; or the repair of products damaged by these modifications.
- H. The Limited Warranty applies only to the product as it existed at the time of the original purchase, by the original retail purchaser, and shall not preclude YAESU MUSEN from later making any changes in design, adding to, or otherwise improving subsequent versions of this product, or impose upon YAESU MUSEN any obligation to modify or alter this product to conform to such changes, or improvements.
- I. YAESU MUSEN assumes no responsibility for any consequential damages caused by, or arising out of, any such defect in materials or workmanship.
- J. TO THE FULLEST EXTENT PERMITTED BY LAW, YAESU MUSEN SHALL NOT BE RESPONSIBLE FOR ANY IMPLIED WARRANTY WITH RESPECT TO THIS PRODUCT.
- K. If the original retail purchaser timely complies with the Warranty Procedures described below, and YAESU MUSEN elects to send the purchaser a replacement product rather than repair the "original product", then the Limited Warranty shall apply to the replacement product only for the remainder of the original product Warranty Period.
- L. Warranty statutes vary from state to state, or country to country, so some of the above limitations may not apply to your location.

Warranty Procedures:

1. To find the Authorized YAESU Service Center in your country/region, visit www.yaesu.com. Contact the YAESU Service Center for specific return and shipping instructions, or contact an authorized YAESU dealer/distributor from whom the product was originally purchased.
2. Include proof of original purchase from an authorized YAESU dealer/distributor, and ship the product, freight pre-paid, to the address provided by the YAESU Service Center in your country/ region.
3. Upon receipt of this product, returned in accordance with the procedures described above, by the YAESU Authorized Service Center, all reasonable efforts will be expended by YAESU MUSEN to cause this product to conform to its original specifications. YAESU MUSEN will return the repaired product (or a replacement product) free of charge to the original purchaser. The decision to repair or replace this product is the sole discretion of YAESU MUSEN.

Other conditions:

YAESU MUSEN'S MAXIMUM LIABILITY SHALL NOT EXCEED THE ACTUAL PURCHASE PRICE PAID FOR THE PRODUCT. IN NO EVENT SHALL YAESU MUSEN BE LIABLE FOR LOSS OF, DAMAGE TO OR CORRUPTION OF STORED DATA, OR FOR SPECIAL, INCIDENTAL, CONSEQUENTIAL, OR INDIRECT DAMAGES, HOW EVER CAUSED; INCLUDING WITHOUT LIMITATION TO THE REPLACEMENT OF EQUIPMENT AND PROPERTY, AND ANY COSTS OF RECOVERING, PROGRAMMING OR REPRODUCING ANY PROGRAM OR DATA STORED IN OR USED WITH THE YAESU PRODUCT.

Some Countries in Europe and some States of the USA do not allow the exclusion or limitation of incidental or consequential damages, or a limitation on how long an implied warranty lasts, so the above limitation or exclusions may not apply. This warranty provides specific rights, there may be other rights available which may vary between countries in Europe or from state to state within the USA.

This Limited Warranty is void if the label bearing the serial number has been removed or defaced.

YAESU

Declaration of Conformity

Type of Equipment: HF/50MHz TRANSCEIVER

Brand Name: YAESU

Model Number: FT-710

Manufacturer: YAESU MUSEN CO., LTD.

Address of Manufacturer: Tennozu Parkside Building, 2-5-8 Higashi-Shinagawa,
Shinagawa-ku, Tokyo 140-0002 Japan

This device complies with part 15 of the FCC Rules. Operation is subject to the following two conditions; (1) this device may not cause harmful interference, and (2) this device must accept any interference received, including interference that may cause undesired operation.

The technical documentation as required by the Conformity Assessment procedures is kept at the following address:

Company: Yaesu U.S.A.

Address: 6125 Phyllis Drive, Cypress, CA 90630, U.S.A.

Telephone: (714) 827-7600

- Changes or modifications to this device that are not expressly approved by YAESU MUSEN could void the user's authorization to operate this device.
- This device complies with part 15 of the FCC Rules. Operation is subject to the following two conditions: (1) This device may not cause harmful interference, and (2) this device must accept any interference including received, interference that may cause undesired operation.
- The scanning receiver in this equipment is incapable of tuning, or readily being altered, by the User to operate within the frequency bands allocated to the Domestic public Cellular Telecommunications Service in Part 22.
- The YAESU MUSEN is not responsible for any changes or modifications not expressly approved by the party responsible for compliance. Such modifications could void the user's authority to operate the equipment.

This device complies with ISED's applicable license-exempt RSS standard(s). Operation is subject to the following two conditions: (1) this device may not cause interference, and (2) this device must accept any interference, including interference that may cause undesired operation of the device.

Le présent appareil est conforme aux CNR d'Industrie Canada applicables aux appareils radio exempts de licence. L'exploitation est autorisée aux deux conditions suivantes : (1) l'appareil ne doit pas produire de brouillage, et (2) l'utilisateur de l'appareil doit accepter tout brouillage radioélectrique subi, même si le brouillage est susceptible d'en compromettre le fonctionnement.

DECLARATION BY MANUFACTURER

The Scanner receiver is not a digital scanner and is incapable of being converted or modified to a digital scanner receiver by any user.

WARNING: MODIFICATION OF THIS DEVICE TO RECEIVE CELLULAR RADIOTELEPHONE SERVICE SIGNALS IS PROHIBITED UNDER FCC RULES AND FEDERAL LAW.

CAN ICES-3 (B) / NMB-3 (B)

This equipment has been tested and found to comply with the limits for a Class B digital device, pursuant to part 15 of the FCC Rules. These limits are designed to provide reasonable protection against harmful interference in a residential installation. This equipment generates, uses, and can radiate radio frequency energy; and, if not installed and used in accordance with the instructions, may cause harmful interference to radio communications. However, there is no guarantee that interference will not occur in a particular installation.

If this equipment does cause harmful interference to radio or television reception, which can be determined by turning the equipment off and on, the user is encouraged to try to correct the interference by one or more of the following measures:

- Reorient or relocate the receiving antenna.
- Increase the separation between the equipment and receiver.
- Connect the equipment into an outlet on a circuit different from that to which the receiver is connected.
- Consult the dealer or an experienced radio/TV technician for help.

Display the Certifications of FCC and CANADA

1. Press the [FUNC] knob.

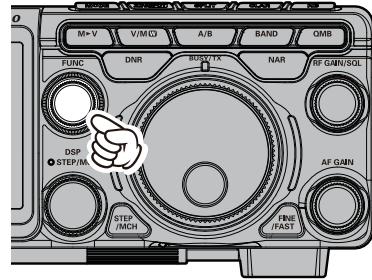

2. Touch [EXTENSION SETTING].



3. Select [CERTIFICATIONS], then touch "DONE" of the "CERTIFICATIONS" item.

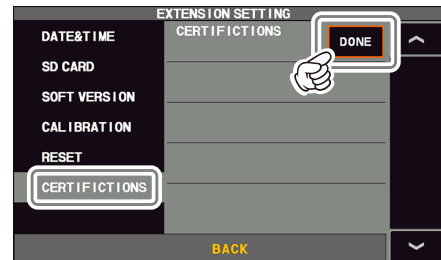

The Certifications of FCC and CANADA are displayed.

4. Touch "BACK" to return to the Setting Menu screen.
5. Touch [BACK] several times to return to normal operation.

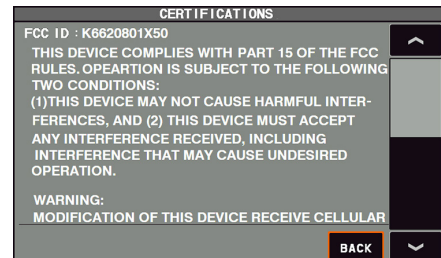

EU Declaration of Conformity

We, Yaesu Musen Co. Ltd of Tokyo, Japan, hereby declare that this radio equipment FT-710 is in full compliance with EU Radio Equipment Directive 2014/53/EU. The full text of the Declaration of Conformity for this product is available to view at <http://www.yaesu.com/jp/red>

ATTENTION – Condition of use

This transceiver operates on frequencies that are regulated. Use of the Transmitter in the EU countries shown in the accompanying table is not permitted without authorization. Users should consult their local spectrum management authority for licensing conditions applicable to this equipment.

					
AT	BE	BG	CY	CZ	DE
DK	ES	EE	FI	FR	UK
EL	HR	HU	IE	IT	LT
LU	LV	MT	NL	PL	PT
RO	SK	SI	SE	CH	IS
LI	NO	-	-	-	-

Disposal of Electronic and Electrical Equipment

Products with the symbol (crossed-out wheeled bin) cannot be disposed as household waste.

Electronic and Electrical Equipment should be recycled at a facility capable of handling these items and their waste by-products.

Please contact a local equipment supplier representative or service center for information about the waste collection system in your country.



YAESU

The radio

Copyright 2023
YAESU MUSEN CO., LTD.
All rights reserved.

No portion of this manual may be
reproduced without the permission of
YAESU MUSEN CO., LTD.

YAESU MUSEN CO., LTD.

Omori Bellport Building D-3F
6-26-3 Minami-Oi, Shinagawa-ku, Tokyo, 140-0013, Japan

YAESU USA

6125 Phyllis Drive, Cypress, CA 90630, U.S.A.

YAESU UK

Unit 12, Sun Valley Business Park, Winnall Close
Winchester, Hampshire, SO23 0LB, U.K.

2211W-DS-4
Printed in Japan



E H 0 8 0 H 2 0 0