

# X6200

HF/50MHz Ultra-Portable Transceiver

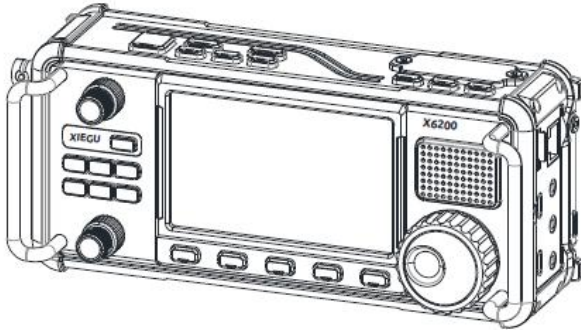

User Manual

Rev . 05

Approval Code: 2BGMW-X6200

Dongguan Weisheng Communication Technology Co., Ltd.



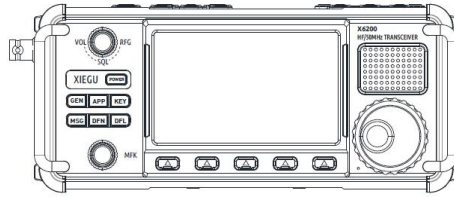

X6200 uses a high-performance DRFS architecture and is equipped with a powerful baseband and RF unit, bringing amateur radio enthusiasts a brand new strong function and more convenient user experience. The new platform architecture provides transceivers with higher receiver sensitivity and lower noise coefficient, allowing for clearer reception of signals from different locations.

In addition, X6200 possesses all the characteristics of a super portable device, making it easy to carry outdoors or while traveling. Its compact design and portability allow users to listen to their favorite signals at any time and any place, making the use of transceivers freer and more flexible.

- Adopt RF direct sampling technology
- HF/50MHZ full mode (supporting data communication)
- WFM broadcast reception, aviation band reception
- Support remote control
- Built-in automatic antenna tuner
- Integrated multi-mode modem, preset message, audio automatic call
- USB interface supports one-line data transmission, control, and automatic reporting to the computer

We recommend you to read through this Manual to rapidly keep abreast of the operation & control method of the X6200 before using it.

Special Note:

- Amateur radio equipment can only be used to set up amateur radio stations and cannot be used to set up radio stations for other radio services.
- Amateur radio equipment can only have the transmitting function in the amateur frequency band.

---

### On/Off prompt!

The startup and shutdown operations of X6200 require some time, please read the following startup and shutdown instructions carefully and pay attention to the operating methods:

#### Startup:

Short press the power switch button until the logo light turns green, then release the power button and wait for the system to start up.

#### Shutdown:

Hold down the power switch button until the display exits, then release the power button.

#### Attention:

- It is recommended to wait for more than 5s between shutdown and startup.
- Please perform the correct shutdown operation and do not forcibly power off to avoid damage to the internal memory.

# CONTENTS

<b>Precautions</b> .....	<b>1</b>	Radio settings 1 menu function description .....	20
Safety precautions .....	1	Radio settings 2 menu function description .....	23
Operation permit .....	1	DISPLAY menu .....	25
Battery precautions .....	2	SYSTEM menu .....	29
Important tips .....	2	MEMORY menu .....	30
Electromagnetic interference .....	2	APP function operation .....	31
<b>Panel Instructions</b> .....	<b>4</b>	MODEM menu .....	31
Front panel .....	4	Automatic sending of preset information .....	32
Right side .....	5	SWR SCAN standing wave scanner operation .....	33
Left side .....	5	FT8 DECODE .....	33
Top button .....	6	Recording automatic call .....	34
H-22 hand microphone .....	7	KEY function operation .....	35
<b>Interface Description</b> .....	<b>8</b>	MSG function operation .....	36
Interface definitions .....	8	Voice recording .....	37
Connection of Electric KEY Port .....	8	DFN function operation .....	38
Power supply wiring .....	9	DFL function operation .....	39
Charging .....	9	Set time/view system information/update firmware/restore factory settings .....	40
Operation of MFK knob .....	11	Set wireless network parameters .....	41
Select language .....	11	Set Bluetooth function .....	42
Function description of each area on the main interface .....	12	Forced shutdown .....	42
"Amateur band operation & mode allocation diagram display area" instruction .....	13	System downtime .....	42
<b>Basic Operation</b> .....	<b>14</b>	<b>Appendix 1</b> .....	<b>43</b>
Turn on/off radio .....	14	Connection between X6200 and XPA125B (L4001 Cable) .....	43
Adjust audio volume .....	14	<b>Appendix 2</b> .....	<b>44</b>
Operating frequency band and mode selection .....	14	Connection between X6200 and Computer for Data Communication & Control .....	44
Set operation frequency .....	15	<b>Appendix 3</b> .....	<b>45</b>
Adjustment of RF gain and muting level .....	15	Setting method of radio end when using remote control software WFSERVER .....	45
SSB/AM/NFM mode transmission ..	16	<b>Parameter</b> .....	<b>46</b>
Transmit in CW mode .....	16	Parameter Specifications .....	46
Automatic antenna tuner .....	16	Packing List .....	47
Use the radio PPT key for transmission .....	17		
FST/Lock button .....	17		
<b>Multi-functional Menu Operation</b> .....	<b>18</b>		
Basic operating methods .....	18		
GEN function operation .....	19		
Menu page-flipping operation .....	19		

## Precautions

### Safety precautions

- Do not use this device in lightning weather. Disconnect the power supply and antenna in advance.
- Do not touch the antenna during the transmission of the device.
- Do not apply AC power to the DC interface on the side panel of transceiver. Otherwise it may cause fire or damages to the device.
- Do not apply more than 15VDC voltage to the DC interface on the side panel of transceiver. Otherwise it may cause fire or damages to the device.
- Do not reverse the polarity of the power cable. Otherwise it may cause fire or damages to the device.
- Do not operate or touch the device with wet hands. Otherwise it may cause electric shock or damages to the device.
- In case of smoke or peculiar smell, cut off the power supply immediately, remove the power cable, and then contact the supplier.
- Do not use the device in areas, vehicles or aircraft where it is prohibited.
- Do not use this device while driving or operating engineering equipment.
- Do not use the device in petrol stations, gas stations or the place with combustible gas around.
- Do not use the device in hospitals or in an environment where people wear medical devices.
- Do not expose the device to rain, snow or any liquid. Otherwise it may cause damages to the device.
- Do not use headphones at high volume.
- Do not disassemble or modify the device.
- Do not place the device near the heat source or in direct sunlight.
- Do not place the device in a dusty or damp place.
- Do not place the device in a poorly ventilated place and do not block any radiator on the device. Otherwise, the device may be damaged due to overheating.
- Do not wipe the device with organic solvents, such as benzene or alcohol. This may damage the surface of the equipment.
- Do not apply impact force to this device, especially to the front where the battery is located. Otherwise it may cause fire or damages to the device.
- Do not place the device in the area with temperature range beyond  $-10^{\circ}\text{C}$ ~ $+50^{\circ}\text{C}$  for storage or use.
- Cut off the power supply, take out the battery panel, and remove the external power cable if the device is not used for a long time.

### Operation permit

- Make sure you have had legal and valid operating certificates or permissions issued by local government departments before making a call on the frequency band of amateur radio.

## Battery precautions

This device contains lithium-ion battery components, so improper use may result in dangers such as smoke, fire or battery rupture.

- The battery panel is installed on the back of the device. Do not hit the battery panel of the device.
- Do not place the device in a place where the temperature is higher than 50°C; otherwise, the battery pack may rupture or catch fire.
- Do not place the back of the device near heat sources, such as stove fire or direct sunlight.
- Do not weld, disassemble or modify battery components by your won. This can lead to protection failure and battery damage, which can further lead to fire and other hazards.
- In case of obvious deformation, seepage or peculiar smell at the installation place of the battery pack, the device shall not be further used, and distributor shall be contacted immediately for assistance.
- Do not use the device beyond its temperature range; otherwise, the service life of the device and battery pack may be reduced or damaged.
- Do not leave the battery pack in fully charged or fully discharged state for a long time. Otherwise, the service life of battery pack will be shortened. Please maintain the electric quantity of battery pack within 40%~50% if the device is to be left unused for a long time, and then keep it properly.
- The service life of the battery pack is about 2 years generally. Please replace the battery pack once its service life reaches this period. Even if the battery still works, its performance will be significantly reduced and service time will be greatly shortened. The battery pack can be generally charged and discharged for around 300 times. This depends on specific usage conditions.
- Do not charge the device with other non-compliant chargers.
- Pay attention to the condition of the device when charging. If any abnormalities occur, please stop charging immediately and remove the battery panel in a safe place.
- Do not charge the device in vehicles under direct sunlight.

## Important tips

- Make sure the antenna feed system meets the transmitting requirements before actual transmitting.
- The device may be extremely hot after continuous and long-term transmitting (such as FT8 operation). Please reduce the transmission power in data communication mode to  $\leq 5W$ , appropriately extend transmitting interval and strengthen external heat dissipation.
- Please place the radio and battery in a safe and reliable place and keep it away from children or unauthorized persons.

## Electromagnetic interference

It shall be noted when using wireless LAN or Bluetooth devices that when other wireless devices, such as wireless mouse, wireless keyboard and wireless router, work in the same frequency band, they may interfere with each other, resulting in unstable or interrupted connection of the device. In such case, please keep away from other devices or stop using those devices.

- **Attention!** When using a monopole antenna ( end-fed antenna, long-wire antenna, etc.), be sure to properly ground the antenna and the radio. At the same time, put an EMC magnetic ring on the end of the feeder near the radio and on the end of various connection lines (data lines, extension lines, audio lines, etc.) near the radio to take anti-interference measures and reduce the interference of radio frequency signals to the radio.

# Panel Instructions

## Front panel

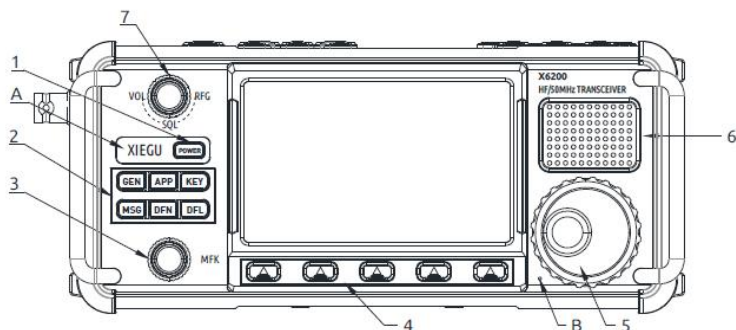

### 1 Power button

Press and hold it to turn on the power supply of transceiver.

Press and hold for 1s to turn off the transceiver power.

### 2 Function button area

#### GEN button

Press it to bring up the general settings menu.

#### APP button

Press it to bring up function menu.

#### KEY button

Press it to bring up taper settings menu.

#### MSG button

Press it to bring up information editing and storage interface.

#### DFN button

Press it to bring up the menu of digital functions.

#### DFL button

Press it to bring up digital filter settings interface.

### 3 MFK multi-function knob

Inner circle: adjust frequency (default)

Outer circle: adjust power (default)

### 4 Multi-function buttons

Press it to execute functions displayed on screen

### 5 Main knob

Rotate it to adjust frequency

### 6 Speaker

### 7 VOL/SQL/RFG knob

Default: volume control.

Press the knob to adjust SQL muting depth.

Press the knob again to adjust RFG gain.

### A LOGO indicator light

The indicator light is green after startup

When the transceiver is in transmitting state, the indicator light is red.

When charging, the indicator light will indicate the current charging status.

### B Built-in MIC speaker hole



## Right side

8 CARD

Micro SD memory card slot.

9 DEV

USB port. Accessory interface.

10 HOST

USB port. Host interface.

11 MIC

Hand microphone interface. The interface is of type RJ45.

12 ACC

It is a 3.5mm stereo interface. See page 8 for interface definitions.

13 KEY

It is a 3.5mm stereo interface used to connect manual/auto tapper. See page 8 for connection.

14 S/P

External speaker/headphone interface, with speaker or headphone output can be set via menu. It is a 3.5mm stereo interface achieving stereo output.

Note: short circuit or silence will be caused if plugging the single track plug externally.

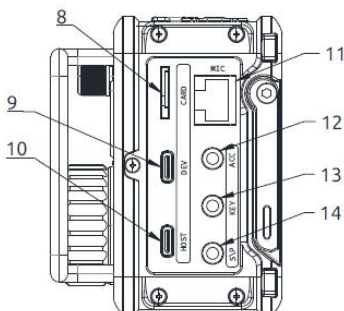

## Left side

15 ANT

BNC interface, 50Ω, for antenna connection.

16 DC IN

External power input/charging port, 5525 type. The inner core is the positive electrode and the outer ring is the negative electrode.

Note: input voltage shall not be higher than 15V DC.

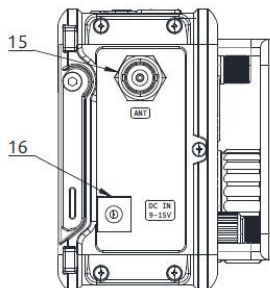

## Top button

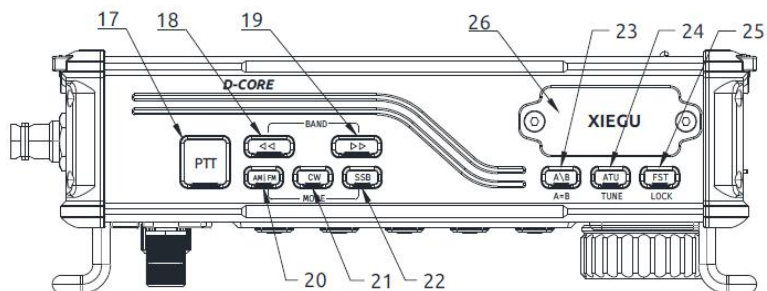

17 PTT

PTT button on device body.

18/19 Left and right switch

Frequency band/channel increase and decrease switch.

20 AM | FM

AM/NFM mode switch button.

21 CW

CW mode switch button.

22 SSB

SSB mode switch button.

23 A/B

Short press: VFOA -VFOB switch button.

Long press: Set VFOA and VFOB to the same parameters.

24 ATU key

Short press: Open the built-in antenna tuner.

Long press: Start the antenna tuner for tuning.

25 FST

Short press: Fast step selection button.

Long press: Lock the buttons and knobs.

26 Expansion component installation position

## H-22 hand microphone

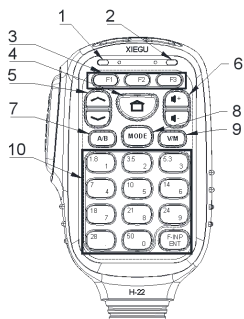

- |  |  |
|--|--|
| 1. Receive status indicator light      | When receiving, the green light turns on.  |
| 2. transmitting status indicator light | When transmitting, the red light turns on.   |
| 3. F1~F3 function keys                 | Custom function button can be set in the host "General Setting 2" menu.  |
| 4. HOME function key                   | Switch to the set frequency, which can be set in the host "General Setting 2" menu.                              |
| 5. Up and down step keys               | Increase or decrease the frequency at the current step.  |
| 6. Volume increase and decrease keys   | Volume increase and decrease.  |
| 7. A/B function keys                   | Shortly press to switch VFOA/VFOB; long hold down to set VFOA/VFOB to be the same.                               |
| 8. MODE function key                   | Switch the current working mode.   |
| 9. V/M function key                    | Switch frequency/channel mode.   |
| 10. Numeric keyboard area              | In the default state, it is the direct frequency band; in the frequency input state, it is the numeric keyboard. |

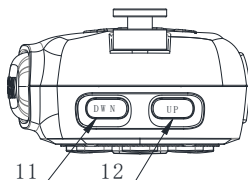



- |              |  |
|--------------|--|
| 11. DOWN key | In channel mode, shortly press the key to decrease the number of channels. |
| 12. UP key   | In channel mode, shortly press the key to increase the channel number.     |

Breathing light effect: If the hand microphone buttons are not used within a certain time, the [F-INP ENT] button on the hand microphone will show the breathing light effect of red brightness gradient.

## Interface Description

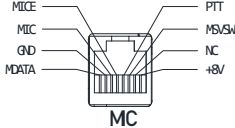
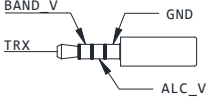
### Interface definitions

Interface name	legend	Interface lead definition	
Hand microphone interface		MICE	Hand microphone grounding
		MIC	Hand microphone signal
		MDATA	Hand microphone data signal
		PTT	PTT signal
		MSVSW	Hand microphone data signal
		NC	Empty
		+8V	8V DC
		GND	Grounding
ACC interface		BAND_V	Band voltage signal
		TRX	Transmission and reception signal
		ALC_V	ALC signal
		GND	Grounding
S/P interface		AUDIO	Audio output
		NC	Empty
		GND	Grounding

## Connection of Electric KEY Port

Connect manual/automatic tapper according to the schematic diagram shown in the right figure.

### Attention:

- If the connector of the manual tapper is a 6.5mm 2-core plug, please change it to a 3-core 3.5mm stereo plug according to the wiring method shown in the right figure, and connect the trigger end of the electric key to the "Di" or "Da" terminal.
- Take care that direct use of the 2-pole to 3-pole adapter or incorrect wiring may result the radio in CW transmission status all the time.

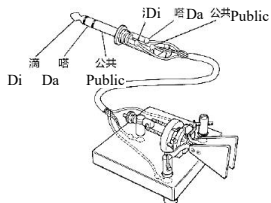

- ◆ Using plugs of other specifications may damage the socket.
- ◆ X6200 may switch to transmitting mode if plugging in or unplugging the tapper plug when it is working.
- ◆ Please cut off the power supply of X6200 before connecting or disconnecting the tapper.

## Power supply wiring

9~15V external **DC power supply** can be used for X6200. The current load capacity of DC power supply shall be at least 3.5A. Attached power lines can be used to connect to radio and DC power supply. DC power supply shall be connected in strict accordance with following figure to avoid reverse polarity connection.

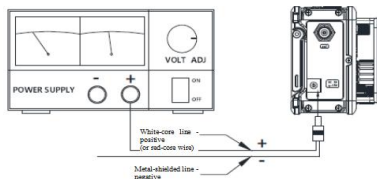

- When using an external power supply, in order to improve anti-interference capability, an EMC magnetic ring can be placed on the power line near the radio.
- When using an external power supply, because the charging unit inside the radio needs to be managed, there will be a current consumption of about 100mA when the device is turned off. This consumption does not exist when only powered by the battery.
- When the external DC power supply voltage is lower than 11V, if the battery is installed, the device automatically switches to the battery power supply.

### Attention:

- Polarity of power lines shall be carefully inspected to avoid reverse polarity connection when external power supply is adopted.
- Reverse connection of power may cause severe damage to the radio.
- Do not charge the radio with any other charger that does not meet the specifications. Otherwise, the device may be damaged.
- Do not connect the external power supply higher than 15V DC. Otherwise, serious radio damage occurs.

## Charging

When the inside of the battery is empty and the color is red, it means that the battery is not installed or the battery is depleted.

Charging Operation Method:

1. In the menu of [SETTING 2], set the option [CHARGER] to ON.
2. Insert the AC terminal of the charging adapter into the mains power supply and the output terminal into the DC interface on the left side of the X6200 to charge.
3. The charging process shall be kept continuous until the charging instruction indicates it has been completed. Full charge time is about 7 hours. The radio will automatically disable charging once the charge is completed.

Charging can be done under startup or shutdown.

1. During startup and charging, the screen indication is as shown in the figure on the right:

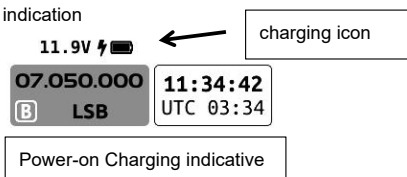

2. During shutdown and charging, the LOGO indicator light is used to indicate the charging status. The indications for each status are as follows:

- ❖ Green light flashing: the charging is in progress.
- ❖ The green light is always on: the battery is full.
- ❖ Off: once the charging option is disabled in the menu, the indicator light will not be off.
- ❖ Red light flashing: the battery is abnormal. At this time, unplug the charger, check if the battery is installed correctly, or reinstall the battery.

### **Attention!**

- When the supplied charger is turned on and charged, it may cause interference to the receiving of the device. It is recommended to charge when the device is turned off.
- When the battery temperature is below 0°C, the device will automatically disable the charging function to protect the battery.
- To charge the X6200, connect the external power supply (DC 12 ~ 13.8V) dedicated to the communication device to the DC port. The device cannot be charged below 12V.
- If after multiple charging, the battery symbol is still displayed in red or empty battery symbol is displayed, indicating that the capacity of the panel has been depleted, or the panel is faulty, please replace the new panel.

#### **Tips!**

- ◆ The supplied adapter cannot be used for any purpose other than charging. Otherwise, the device may be damaged.
- ◆ The DC port on the left of the X6200 can not be connected to a voltage higher than 15VDC. Otherwise, serious device damage may occur.

## Operation of MFK knob

1. The MFK knob is divided into an inner circle and an outer circle. When the inner circle and outer circle rotate by 2 steps each, the device operates one time.

2. The functions of the inner circle and outer circle of the MFK knob vary in different interfaces.

- In the main interface:

Inner circle function: adjust frequency.

Outer circle function: adjust power.

- In the menu page:

Inner circle function: adjust the parameters of the currently selected item.

Outer circle function: select different function options.

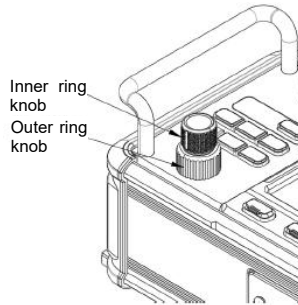

## Select language

The display interface of X6200 supports Chinese and English languages, and users can choose the corresponding language according to their needs.

Set methods:

1. The default startup interface is English. Press [SYSTEM] key in a short time to enter the system setting.

2. Rotate the outer circle of MFK, select [Language Settings], press the MFK button to enter the language selection interface, as shown in the following figure:

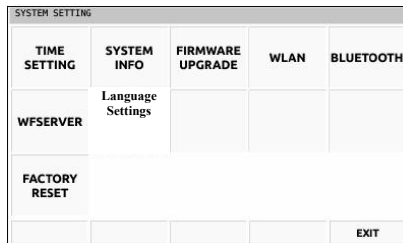

Rotate the inner circle of MFK, select the desired language, press the corresponding [OK] button at the bottom of the screen to complete the setting. As shown in the figure below:

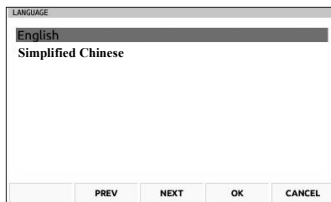

## Function description of each area on the main interface

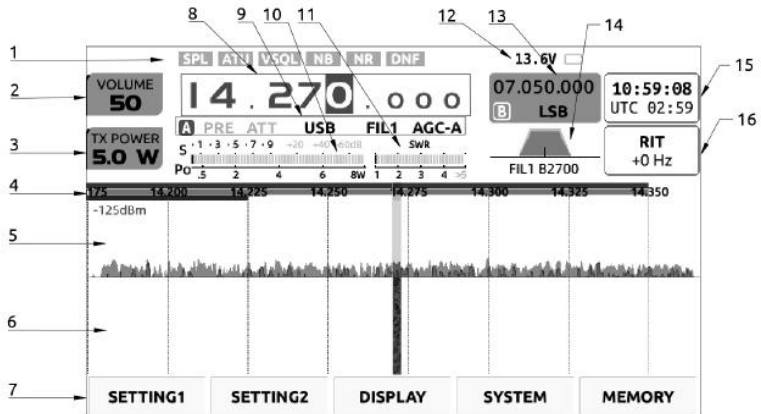

### 1. Status display area 1

This area displays SPL, ATU, SQL, NB, NR and DNF switch status.

### 2. Volume label

Display volume/noise level/RF gain adjustment.

Short press the volume knob to switch the above three status.

### 3. Multi-function quick tags

The figure shows the transmitting power adjustment tag. Items of the tag displayed can be rapidly set via menu.

4. Amateur band operation level and mode allocation diagram display area

### 5. Spectrum display area

6. Waterfall diagram display area

### 7. Multi-function menu area

Short press the corresponding button at the bottom of the screen to operate corresponding functions.

8. VFO-A frequency display area

### 9. Status display area 2

This area displays PRE/ATT/mode /AGC status

### 10. Meter header display area 1

This area displays the S meter and transmission gain power meter

### 11. Meter header display area 2

This area displays the emission standing wave meter

### 12. Meter header display area 3

This area displays information such as LAN/battery.

The current displayed value is the external voltage.

### 13. VFOB parameter display area

### 14. Filter parameter display area

### 15. Time display area

### 16. RIT parameter display area



## “Amateur band operation & mode allocation diagram display area” instruction

At the top of the spectrum display area of the main interface of the radio, there will be colored bar charts of different colors, which is the “amateur band mode allocation diagram”. It is used to identify the operating level and the corresponding operating frequency band and mode information in each frequency band.

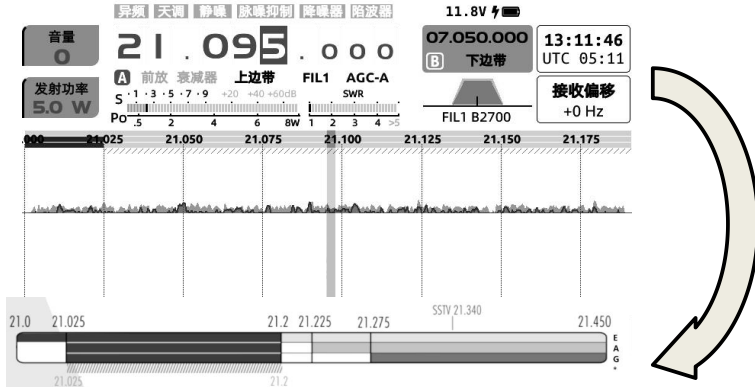

1. As shown in the figure above, there are 3 color bars and 1 diagonal color bar from top to bottom in this area, which are represented by characters E, A, and \* respectively. The specific meanings are as follows:

E: Extra, Extra operator band

A: Advanced, Advanced operator band

G: General, General operator band

\*: Novice and Technician, Novice and Technician operator band

2. The operation levels and modes represented by the color bars of the allocation chart are as follows:

Bright yellow: Extra operator: voice mode, CW telegrams mode, Image transmission

Orange: Advanced operator band: voice mode, CW telegrams mode, Image transmission

Blue: General operator band: voice mode, CW telegrams mode, Image transmission

Red: CW RTTY DATA(data mode)

Green slash: Novice and Technician: CW

Blue slash: Novice and Technician: voice mode

Blank area: No permission

- The machine adopts allocation diagram information is for the convenience of the operator to quickly determine the commonly used working mode, and the operation level of some countries or regions, pattern planning there may be a discrepancy, the local actual laws and regulations shall prevail.

## Basic Operation

### Turn on/off radio

Operation method:

**Power on:**  
Shortly press the power button and the LOGO green light will light up. Release the power button and wait for the system to start up.

**Shutdown:**  
Press and hold the power button until the display interface exits, then release the power button.

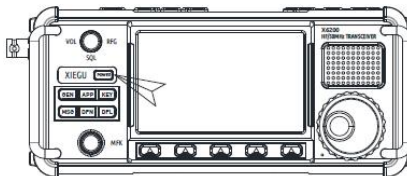

### Adjust audio volume

Operation method:

1. Turn the volume knob to the left or right to adjust the output volume.
2. Short press the volume knob to switch volume/muting depth/RF gain adjustment.

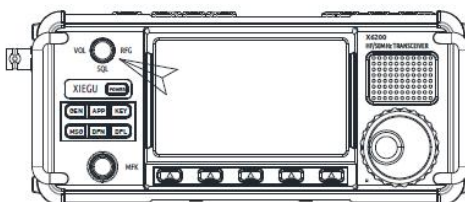

### Operating frequency band and mode selection

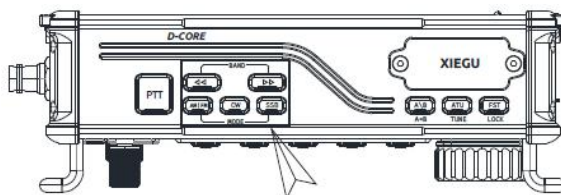

Operation method:

1. Press the corresponding mode button at the top of the radio to switch to corresponding mode.
2. Press left or right [←][→] button to orderly switch operation frequency band:  
1.8MHz ↔ 3.5MHz ↔ 7MHz ↔ 10MHz ↔ 14MHz ↔ 18MHz ↔ .....  
21MHz ↔ 24MHz ↔ 28MHz ↔ 50MHz ↔ WFM frequency band ↔ aviation frequency band
3. Figure buttons on hand microphone can be used to directly switch to corresponding amateur band.

## Set operation frequency

Operation method:

1. Rotate large knob to set the frequency. Clockwise rotate the knob to increase the operating frequency and anticlockwise rotate the knob to decrease the operating frequency.
2. Press the top [FST] button to change the frequency adjustment position for fast adjustment.



3. Set frequency by multi-function hand microphone:
  - a. Press [F - INP ENT] key on hand microphone, and the X6200 will be in frequency setting state, and cursor will be flickering at the first place on the left of frequency display position;
  - b. Input expected frequency values one by one, and press [F - INP ENT] key again to complete the frequency setting.

For example, press buttons in following sequence to set current frequency as 14.25000MHz:

1. Press [F - INP ENT] firstly;
2. Press 1, 4, 2, 5, 0, 0 and 0 number keys one by one;
3. Press [F - INP ENT] key again to complete the setting.

## Adjustment of RF gain and muting level

Proper RF gain can facilitate to improve the quality of signal received. In general, appropriately reducing the RF gain value at some low-frequency ranges with strong interference can significantly improve the receiving effect.

Adjustment methods of RF gain:

1. Short press the volume knob continuously to bring up the RF GAIN setting items. The tag on the left side of the screen will display RF GAIN.
2. Rotate the volume knob to adjust the RF gain value.

SQL tuning method:

When muting is necessary for signals or noise less than a certain amplitudes, appropriate muting level can be set to disable the audio switch without signal so that the speaker can be muted.

1. Short press the volume knob continuously to bring up the SQL setting items. The tag on the left side of the screen will display SQL Level.
2. Rotate the volume knob to set the muting level. At the same time, the muting grade will display on the screen.
  - The muting grade gradually strengthens from S1 ~S9, corresponding to strength of S meter. For example, when the muting grade is set to be S3, it indicates that the speaker will sound when the signal strength is more than S3. Otherwise, the speaker will in the silent mode.

## SSB/AM/NFM mode transmission

Operation method:

1. Press the PTT button on the microphone to start transmitting. Please speak to the microphone in a normal voice.
2. During the transmitting, the transmission indicator light on X6200 will turn red, as will the indicator light on hand microphone.
3. Release the PTT button to return to the receiving state.

## Transmit in CW mode

Insert the KEY interface on the right side of the X6200 with a manual key or an external key. (see Page 7 for the definition of wiring)

Operation method:

1. Insert the key plug into the KEY interface;
  2. Press [CW] button on the top of radio to switch mode to CW (or CWR);
  3. Turn on QSK function in menu and set appropriate QSK time;
  4. Press telegram key to enable CW communication.
- If the "CW TRAINER" trainer is enabled in the KEY menu, there will be only CW sidetone of transceiver after the key is pressed, but actual signal will not be transmitted externally.

## Automatic antenna tuner

There is an efficient ATU integrated inside the X6200 radio to help you quickly erect and debug antenna.

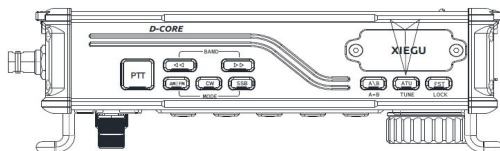

1. Press [ATU] key in a short time to connect with built-in antenna tuner. There will be an antenna icon at the top of screen.
2. In the case that the antenna tuner is accessed, long press and hold the [ATU] key for 1s to start ATU automatic tuning functions. It will automatically return to receiving state after the tuning.

### Attention!

1. Short press [ATU] key, and there will be an ATU icon at the top of screen, indicating that antenna tuning functions are enabled. The functions are only enabled but not working.
2. After the antenna tuner is tuned, the antenna tuner must remain to be open before the antenna tuner in the machine is used.
3. If "ATU" icon is displayed at the top of the screen and flashes once transmitting is enabled after the tuning, it indicates that standing-wave of current antenna is still large and tuning is required to be carried out again.
4. Antenna tuning shall be turned off once natural resonance of antenna reaches current frequency band.
5. When a whip or monopole antenna is used and the internal antenna tuning is started for tuning, strong radio frequency interference may be caused to the unit or other electronic equipment.

## Use the radio PPT key for transmission

The X6200 body integrates PTT button and built-in microphone, which make it convenient when using the radio outdoors.

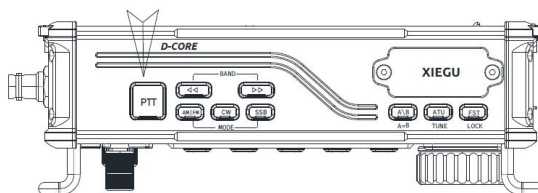

### Operation method:

1. Press the PTT button on the top of the device and speak to the built-in microphone hole at the left of large knob to transmit voice.
2. Release the PTT button after transmitting to return to receiving status.

### Attention!

- Do not place the antenna very close to or near exposed parts of the body, especially the face or eyes, when transmitting in hands.

## FST/Lock button

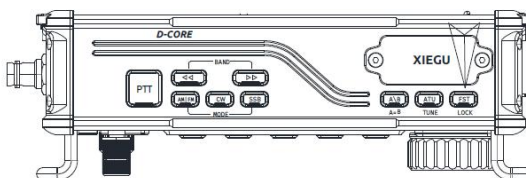

### Adjust the step operation method:

Short press the top [FST] button, and the step will switch between the tens, hundreds, and thousands of the VFO-A frequency. The current step digit has a green block selected to display the effect.

### Locking operation method:

Long press the [FST] button at the top to lock the operation of main knob, and the symbol of "Lock" will be displayed at the upper right of the screen.

## Multi-functional Menu Operation

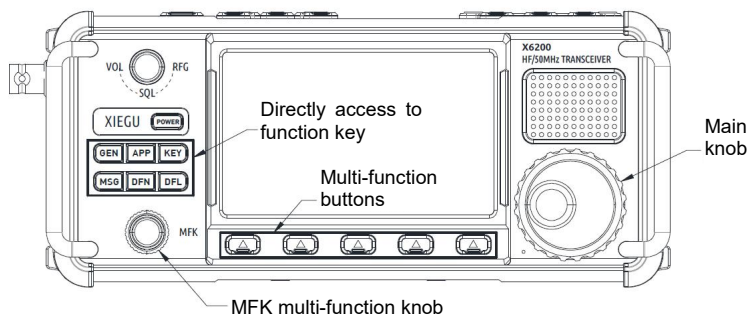

## Basic operating methods

1. Function buttons in the left area of the panel can directly access the main interface of the common function operation menu.
  2. After selecting of the function buttons, the corresponding multi-function menu will appear at the bottom of the screen. Short press the corresponding button at the bottom of the screen to enter the corresponding menu page.
  3. After entering the relevant menu page, rotate the MFK knob outer ring to select different submenu items, rotate the MFK knob inner ring to adjust the selected submenu parameters.
- The X6200 can display both English and Chinese interfaces. The following operation steps are illustrated in English interface, and explained with Chinese definitions. Users using Chinese can directly switch to the Chinese menu display state.

## GEN function operation

After short pressing the [GEN] key, the Default menu will appear at the bottom of the screen, as shown in the following figure:

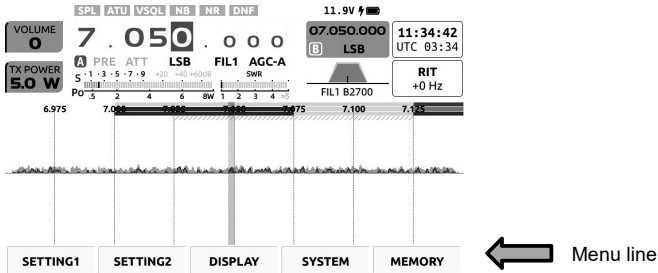





Short press the key corresponding to [SETTING1] to enter the “Radio Setting 1” submenu, as shown in the following figure:

Operation method:

1. Rotate the MFK outer knob and scroll to select the item to be adjusted. As shown in the right figure, select the “PRE” Options.
2. Rotate the MFK inner knob to adjust the value of the current item.

Operational icon 

SETTING1(1/2) GENERAL				
PRE OFF	ATT OFF	AGC AUTO	TX POWER 5.0 W	MIC SEL AUTO
BUILT-IN MIC GAIN 0	HANDLE MIC GAIN 0	LINE IN GAIN 10	LINE OUT GAIN 10	MONITOR LEVEL 0
COMP OFF	SSB STEP 1k	CW STEP 100	AM STEP 10k	WFM STEP 100k
DEFAULT	PREV	NEXT	SELECT	EXIT
				
Default	Previous menu	Next menu	Set as shortcut	Exit the menu

## Menu page-flipping operation

SETTING1 (1/2) GENERAL is displayed at the top of the page, indicating that there are two pages in the menu. The current page is page 1.

1. Short press [NEXT] to enter the second page menu.
2. Short press the [PREV] button to return to the previous menu.

## Radio settings 1 menu function description

“Radio Settings 1-1” menu functions and operation instruction:

Serial number	Menu item name	function	Operation instruction
1	PRE	Pre-amplification	When receiving weak signal, select ON to open the preamplifier. When the signal is strong, it is recommended to turn off the preamplifier.
2	ATT	Pre-attenuation	It is recommended that when the received signal strength is greater than S9+10dB, select ON and turn on the pre-attenuator to avoid receiver blocking.
3	AGC	Automatic gain	OFF, SLOW, FAST, and AUTO are available. Selecting AUTO, the device automatically sets the AGC rate according to the current mode.
4	TX POWER	Transmission power	With 0.5 W stepping transmission power adjustment.
5	MIC SEL	Microphone selection	AUTO (automatic selection), BUILT-IN (built-in microphone), and HANDLE (external hand microphone) are available. It is recommended to select AUTO mode. In this mode, inserting the external hand microphone means using the external hand microphone, and not inserting the external hand microphone means using the internal microphone.
6	BUILT-IN MIC GAIN	Microphone gain	If the power is low when using the built-in microphone to transmit voice, the value of this parameter can be appropriately increased. Note that large parameter values may cause over-modulation of the voice.
7	HANDLE MIC GAIN	Hand microphone gain	If the power is low when using the external microphone to



			transmit voice, the value of this parameter can be appropriately increased. Note that large parameter values may cause over-modulation of the voice.
8	LINE IN GAIN	Line input gain	When connecting to the computer for data communication, if the external input audio signal is too low, the value of this parameter can be appropriately increased.
9	LINE OUT GAIN	Line output gain	When connecting to the computer for data communication, if the radio output audio signal is too low, the value of this parameter can be appropriately increased.
10	MONITOR LEVEL	Monitoring level	When using recording call, This option can adjust the volume of the speaker output monitor voice. Note that the monitoring volume shall not be set too large, otherwise it may cause a sound echo.
11	COMP	Speech compression switch	Turn on this switch to start the speech compression function, which can make the transmission power of the voice mode more stable.
12	SSB STEP	SSB step	SSB mode step frequency selection.
13	CW STEP	CW step	CW mode step frequency selection.
14	AM STEP	AM step	AM mode step frequency selection.
15	WFM STEP	WFM step	WFM step frequency selection.

“Radio setting 1-2” menu

SETTING1(2/2) AUDIO EQUALIZER				
EQ RX 300Hz 0	EQ RX 700Hz 0	EQ RX 1200Hz 0	EQ RX 1800Hz 0	EQ RX 2300Hz 0
EQ WFM 50Hz 0	EQ WFM 300Hz 0	EQ WFM 1500Hz 0	EQ WFM 5000Hz 0	EQ WFM 12000Hz 0
EQ MIC 300Hz 0	EQ MIC 700Hz 0	EQ MIC 1200Hz 0	EQ MIC 1800Hz 0	EQ MIC 2300Hz 0
EQ-RX OFF	EQ-RX(WFM) OFF	EQ-MIC OFF		
DEFAULT	PREV	NEXT	SELECT	EXIT

This menu is the interface of the mixer, which can adjust the frequency response of short wave receiving audio, FM broadcast receiving audio, and Mic audio.

Before setting the EQ parameters, turn on the corresponding EQ switch: EQ-RX, EQ-RX (WFM), or EQ-MIC.

EQ RX 300Hz	EQ RX 700Hz	EQ RX 1200Hz	EQ RX 1800Hz	EQ RX 2300Hz
Short wave receiving frequency response adjustment				
EQ WFM 50Hz	EQ WFM 300Hz	EQ WFM 1500Hz	EQ WFM 5000Hz	EQ WFM 12000Hz
FM broadcast receiving frequency response adjustment				
EQ MIC 300Hz	EQ MIC 300Hz	EQ MIC 300Hz	EQ MIC 300Hz	EQ MIC 300Hz
Mic frequency response adjustment				
EQ-RX OFF	EQ-RX(WFM) OFF	EQ-MIC OFF	///	///
Short wave EQ switch	FM broadcast EQ switch	Mic EQ switch		

Shortly press the key corresponding to [SETTING 2] to enter the “Radio Setting 2” submenu, as shown in the following figure:

SETTING2(1/1) MISCS				
RIT 0	XIT 0	HANDLE F1 PRE	HANDLE F2 NR	HANDLE F3 FILTER
SPLF OFF	PTT MODE NORMAL	BANDSTACK HAM BAND	S/P MODE SPEAKER	CHARGER ON
DEFAULT	PREV	NEXT	SELECT	EXIT

## Radio settings 2 menu function description

“Radio Settings 2” menu functions and operation instruction:

Serial number	Menu item name	function	Operation instruction
1	RIT	Receiving offset	Receive frequency fine-tuning.
2	XIT	Emission offset	Transmit frequency fine-tuning.
3	HANDLE F1	Hand microphone F1 key setting	Function setting of F1 button on H-22 hand microphone. The default setting is PRE switch.
4	HANDLE F2	Hand microphone F2 key setting	Function setting of F2 button on H-22 hand microphone 4. The default is NR switch.
5	HANDLE F3	Hand microphone F3 key setting	Function setting of F3 button on H-22 hand microphone. The default setting is filter option.
6	SPLE	Split frequency transmission and reception	When set to ON, the VFOA frequency is used as the receive frequency and the VFOB frequency is used as the transmit frequency.
7	PTT MODE	PTT mode	NORMAL mode, press PTT to transmit, release PTT and return to receive mode. In TOGGLE (trigger) mode, press the PTT button once, and the radio will be in the transmitting state until PTT is pressed again. The default mode is NORMAL.
8	BANDSTACK	Bands register	HAM BAND (Amateur radio band only), ALL BAND (all bands) are available. If HAM BAND is selected and press the BAND button to switch bands, switch in amateur bands only. The default is HAM BAND.

9	S/P MODE	Speaker/headphone mode	<p>Select the output status of the S/P port on the right side of the device body. The options are EAR PHONE (ear phone mode) and SPEAKER (speaker mode).When connecting headphones outside the S/P port, select EAR PHONE. When connecting speakers outside the S/P port, select SPEAKER.Please note that when selecting a SPEAKER, do not connect the earphones and listen to it. Otherwise, it may damage the earphones and hearing.</p>
10	CHARGER	Charging switch	<p>If the battery needs to be charged, please select ON. When no charging is required, select OFF.</p>
11	BUILT-IN Wifi/bluetooth	Built-in wireless adapter switch	<p>When using an external wireless adapter, set this to OFF. Internal and external adapters cannot be used at the same time.</p>

## DISPLAY menu

Short press the key corresponding to [DISPLAY] to enter the “Display Setting” submenu, as shown in the following figure:

DISPLAY(1/2)				
RF FFT AVERAGE 0	RF FFT REF LEVEL 0 dBm	RF FFT SPAN 192k	RF FFT PEAK HOLD ON	CW ZOOM OFF
AUDIO FFT AVERAGE 0	AUDIO FFT REF LEVEL 0 dBFs	WF MOVE OFF	WATERFALL REF LEVEL 0 dBm	WATERFALL COLOR MAP Jet
AUDIO SCOPE OFF	SCOPE Y GRID STYLE SCOPE+WF	SCOPE/WF HEIGHT RATIO 45 %	SCOPE LINE WIDTH 2	CENTER LINE ON
PARAMETER TEXT COLOR GREEN	BACKLIGHT LEVEL 5	SCREEN SAVER OFF	SCREEN DIM TIME 1 min	SCREEN OFF TIME 1 min
DEFAULT	PREV	NEXT	SELECT	EXIT



“Display Settings 1/2” menu functions and operation instruction:

Serial number	Menu item name	function	Operation instruction
1	RF FFT AVERAGE	RF spectrum average	Adjusting this parameter can appropriately reduce the peak beat of the spectrum and make the spectrum display smoother.
2	RF FFT REF LEVEL	RF spectrum reference	By adjusting this parameter, the appropriate RF spectrum noise can be set according to the current noise level.
3	RF FFT SPAN	RF spectrum bandwidth	Spectrum bandwidth Setting.The frequency bandwidth displayed in the spectrum window on the main interface can be adjusted to 384k, 192k, 96k, and 48k.
4	RF FFT PEAK HOLD	Spectrum peak maintenance	Spectrum peak maintenance setting switch.When this option is set to ON, a temporary image of the signal peak is displayed on the spectrum. When OFF is selected, this function is disabled.
5	CW ZOOM	CW scaling	In CW mode, adjusting this option will focus on the current frequency and narrow the spectrum display window for a clearer view of CW signals. 2, 4, 8x zoom rate is available. When

			OFF is selected, this function is disabled.
6	AUDIO FFT AVERAGE	Audio spectrum average	Adjusting this parameter can appropriately reduce the peak beat of the audio spectrum window and make the audio spectrum display smoother.
7	AUDIO FFT REF LEVEL	Audio spectrum reference	By adjusting this parameter, the appropriate audio spectrum noise can be set according to the current noise level.
8	WF MOVE	Waterfall move	After this function is turned on, when the VFO frequency is adjusted, the waterfall diagram moves with the VFO frequency as a whole.
9	WATERFALL REF LEVEL	Waterfall reference	This option is used to adjust the visual effect of the waterfall diagram and improve the visual discernment of the signal. If the waterfall diagram display is too bright or too dark, this parameter can be adjusted. The adjustment range of this parameter is $\pm 20\text{dBm}$ .
10	WATERFALL COLOR MAP	Waterfall coloring	A variety of waterfall coloring schemes are built in for user customization.
11	AUDIO SCOPE	Audio waveform	Audio waveform and spectrum window switch. After opening, the audio spectrum and audio waveform window will be displayed on the right side of the spectrum/Waterfall display area on the main interface.
12	SCOPE Y GRID STYLE	Spectrum Y scale style	This option sets the display area of the frequency standard dotted line. Select SCOPE, only display the frequency standard dotted line on the spectrogram; Select SCOPE+WF, display dotted

			lines in both the spectrum diagram and the waterfall diagram.
13	SCOPE/WF HEIGHT RATIO	Spectrum/waterfall ratio	This option adjusts the display ratio of the spectrum window and waterfall window.
14	SCOPE LINE WIDTH	Spectrum line width	This option adjusts the width of the spectrum line.
15	CENTER LINE	Spectrum center line	Turn on or off the red marker in the center of the spectrum.
16	PARAMETER TEXT COLOR	Parameter character color	Adjust the color of each setting parameter in the multi-function menu.
17	BACKLIGHT LEVEL	Backlight brightness	Adjust the screen backlight brightness, 1 to 10 levels are available.
18	SCREEN SAVER	Screen saver	Screen saver switch. After it is turned on, the Settings for options 19 and 20 are valid.
19	SCREEN DIM TIME	Backlight dimming time	Automatic dimming time of screen backlight brightness.
20	SCREEN OFF TIME	Backlight off time	Screen backlight off time

“Display Settings 2/2” menu functions and operation instruction:

DISPLAY(2/2)				
	SCOPE LINE RED 0	SCOPE LINE GREEN 255	SCOPE LINE BLUE 0	SCOPE LINE ALPHA 255
	SCOPE FILL RED 0	SCOPE FILL GREEN 255	SCOPE FILL BLUE 0	SCOPE FILL ALPHA 100
	BW MARKER RED 255	BW MARKER GREEN 255	BW MARKER BLUE 0	BW MARKER ALPHA 64
DEFAULT	PREV	NEXT	SELECT	EXIT

This menu provides a personalized color adjustment function, which can be customized to configure the color of the spectrum line, spectrum filling and bandwidth marking according to your preferences. Adjusting the values three primary colors of red, green, and blue, with transparency adjustment, can display a variety of visual effects, and show the current color matching at actual time on the left palette.

Menu function are defined as follows:

RF spectral line color	SCPOE LINE RED	SCPOE LINE GREEN	SCPOE LINE BLUE	SCPOE LINE ALPHA
	red	green	blue	transparency
RF spectrum fill color	SCPOE FILL RED	SCPOE FILL GREEN	SCPOE FILL BLUE	SCPOE FILL ALPHA
	red	green	blue	transparency
Bandwidth marker color	BW MARKER RED	BW MARKER GREEN	BW MARKER BLUE	BW MARKER ALPHA
	red	green	blue	transparency



## SYSTEM menu

Short press the key corresponding to [SYSTEM] to enter the “System Setting” submenu, as shown in the following figure:

SYSTEM SETTING				
TIME SETTING	SYSTEM INFO	FIRMWARE UPGRADE	WLAN	BLUETOOTH
WFSEVER	Language Settings			
FACTORY RESET				
				EXIT

“System Settings” menu function definition and operation instructions:

Serial number	Menu item name	Function	Operation instruction
1	TIME SETTING	Time setting	Set the values of the year, month, day, hour, minute, and second, and the address of the time server.
2	SYSTEM INFO	System information	View firmware version information.
3	FIRMWARE UPGRADE	Firmware upgrade	Upgrade baseband firmware.
4	WLAN	Wireless network	Set the parameters of the wireless network. See the Wireless Settings section for details.
5	BLUETOOTH	Bluetooth	Set Bluetooth parameters. See the Bluetooth section for details.
6	WFSEVER	Remove control	Set the parameters of the WF service. See the WF Setup section for details.
7	Language setting	Select English and Chinese	Select Chinese or English as system language.
8	FACTORY RESET	Restore factory setting	Restore factory setting parameters

## MEMORY menu

Short press the key corresponding to [MEMORY] to enter the “Memory setting” submenu, as shown in the following figure:

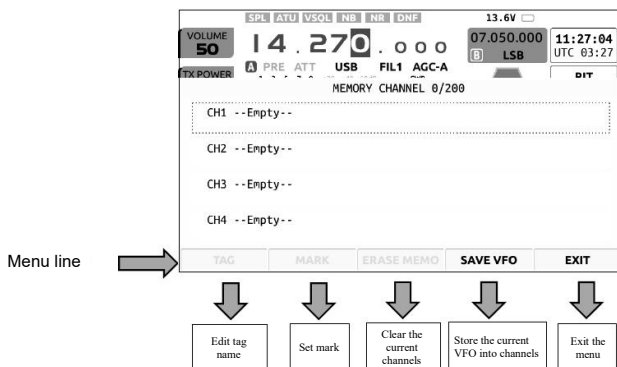

Example of Memory Channel Operation:

The current frequency is VFOA: 14.270000/USB, VFOB: 7.050000/LSB

1. Short press [SAVE VFO] to save the current frequency, mode, etc. into a blank channel. As shown in the figure below:



2. Short press [TAG] to name the current channel.
3. Short press [MARK] to mark the current channel, and the symbol of a small house will be displayed on the channel tag.

Example of Clearing Channel Operation:

1. Turn the main knob to select the channel tag you want to clear.
2. Short press [ERASE MEMO] to clear the channel information of the memory.

## APP function operation

Short press the [APP] button on the upper left side of the panel to enter the “Application” submenu, as shown in the following figure:

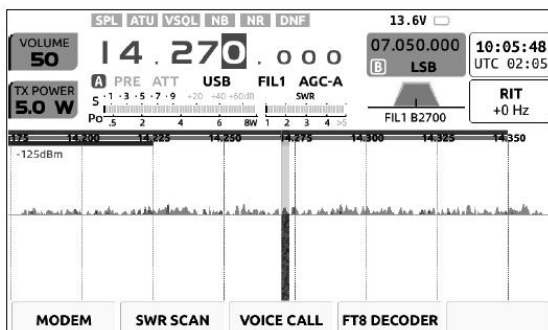

Menu functions are defined as follows:

MODEM	SWR SCAN	VOICE CALL	FT8 DECODER	---
Modem	Standing-wave scanning	Voice call	FT8 decoder	---

## MODEM menu

Short press the corresponding key of [MODEM] to enter the sub-menu of the “Modem”, as shown in the figure below:

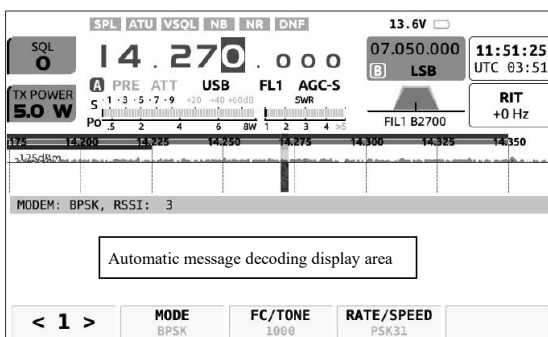

The submenu <1> is defined as follows:

<1>	MODE	FC/TONE	RATE/SPEED	---
	Select RTTY/CW/BPSK mode	Carrier/side tone frequency	Baud rate/code rate	

Short press the key corresponding to <1> below the screen again to enter the submenu <2>, defined as follows:

<2>	AFC	SQL	CLEAR	EXIT
	Carrier tracking	Modem muting	Clear text	Exit

## Automatic sending of preset information

In the MODEM interface, short press the [MSG] key on the left side of the panel to enter the automatic message sending interface, as shown in the figure below:

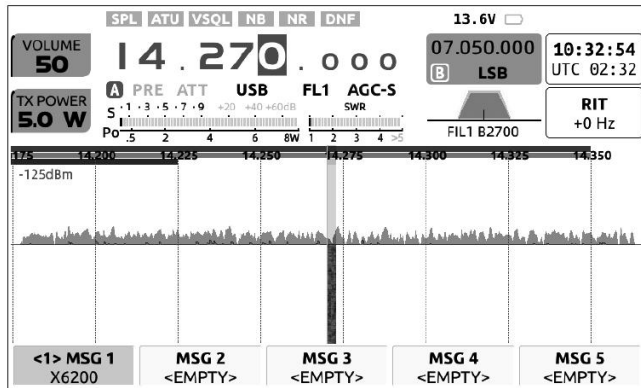

Operation method:

1. When a tag has pre-stored information, there is information preview under the tag. The above figure shows that: MSG1 tag already has pre-stored information; the tag has information preview, which is convenient for users to quickly find the required call tag.
2. Press the corresponding tag, X6200 will start sending the preset text information in the tag in the mode (CW, PSK, PTTY) selected by MODEM until the sending of information is completed.

- The editing method of preset information is detailed in the “MSG function Operation” section

## SWR SCAN standing wave scanner operation

The X6200 has the antenna standing-wave scanner, which can scan the standing-wave parameters of the current antenna to help users adjust the antenna.

Operation method: Short press the corresponding key of [SWR SCAN] to enter the sub-menu of the "Standing-wave Scanner", as shown in the figure below:

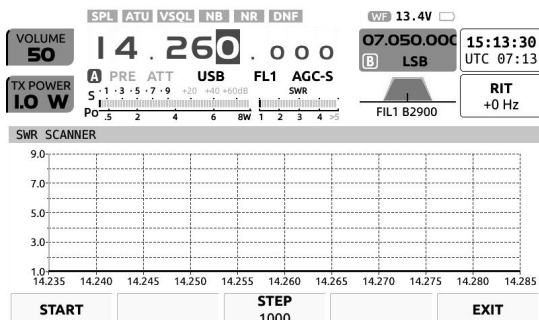

Menu functions are defined as follows:

START	---	STEP	---	EXIT
Start scanning	---	Scan step	---	Exit

**START:** Short press this button to start scanning. Short press again to stop scanning.

**STEP:** Short press this button to change the scanning step.

**EXIT:** exit the standing-wave scanner interface.

- The scanning results from the standing-wave scanner may have some errors, for reference only of temporary use. For accurate measurement of antenna standing waves and other data, please use the professional antenna analysis equipment for measurement.

## FT8 DECODE

The X6200 can directly decode and display information for FT8 communication.

Operation sequence:

[APP] - [FT8 DECODER], enter the FT8 decoding interface. The demodulated information will be displayed overlaid in the spectrum area, as shown in the following figure:

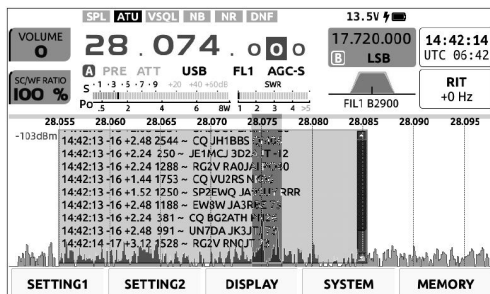

## Recording automatic call

X6200 has a built-in recording caller, which can record and store the call voice in the machine in advance, and the stored voice can be used for call transmission.

Operation sequence:

[APP] - [VOICE CALL], enter the recording call interface, as shown in the figure below:

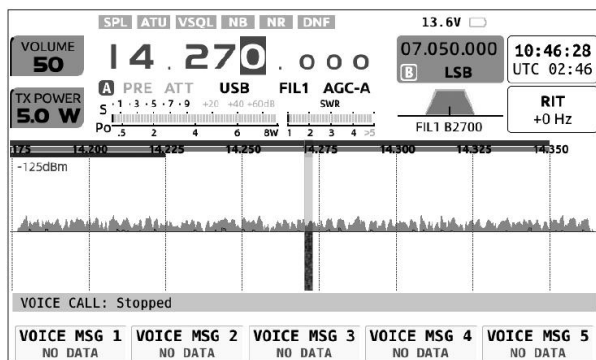

Operation method:

1. When a tag has pre-stored information, there is a prompt under the tag to facilitate users to quickly find the required call tag.
  2. Press the corresponding tag, X6200 will start sending the preset recording information in the tag until the sending of information is completed.
- The recording method of voice message is detailed in chapter "Voice Recording".

## KEY function operation

1. Short press [KEY] to enter the menu of KEY items, as shown in the figure below:

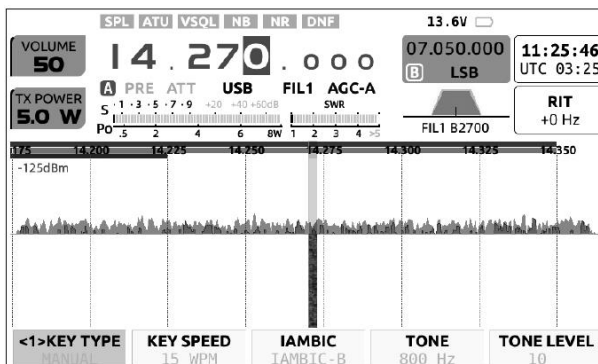

The function of menu <1> is defined as follows:

KEY TYPE	KEY SPEED	IAMBIC	TONE	TONE LEVEL
Key mode	Auto key speed	Alternate mode	Beat frequency	Beat frequency volume

2. Press the [KEY] key again to enter the menu on the second page of KEY items.

The function of menu <2> is defined as follows:

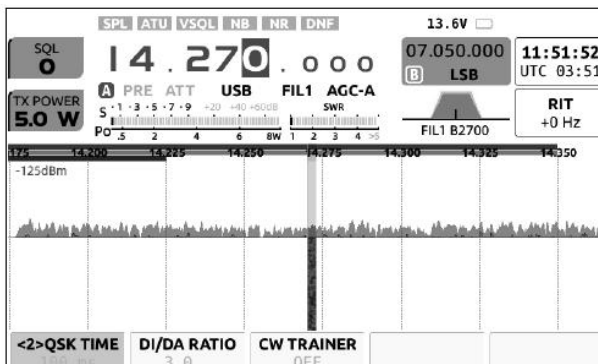

QSK TIME	DI/DA RATIO	CW TRAINER	---	---
CW transmit-receive switching time	Dot-and-dash ratio	CW trainer	---	---

## MSG function operation

Short press [MSG] to enter the text preset menu on the first page of MSG, as shown below:

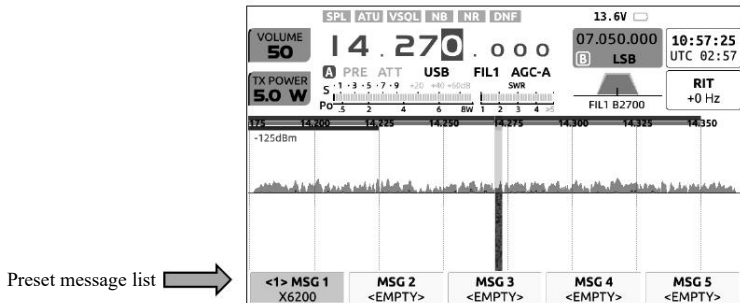

X6200 can pre-store 5 preset messages. These messages can be used for automatic transmission of CW, RTTY and BPSK. Click any MGS label to enter the editing interface, as shown below:

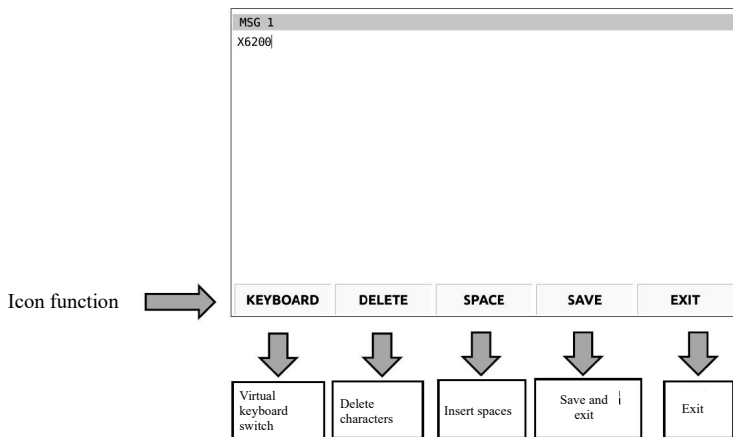

Open the virtual keyboard as shown in the figure on the right:

1. Rotate the MFK inner or outer knob to select the character to enter.
2. Press the MFK knob to determine to enter the current character.
3. Press the [KEYBOARD] button again to switch to the digit symbol and IPv4 digit input interface.
4. Press the button corresponding to [Close] to exit the virtual keyboard.

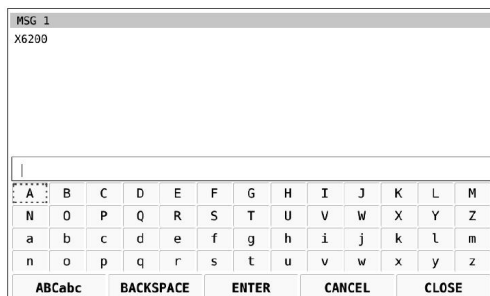



## Voice recording

Press [MSG] again to enter the voice recording menu page on the second page of MSG options:

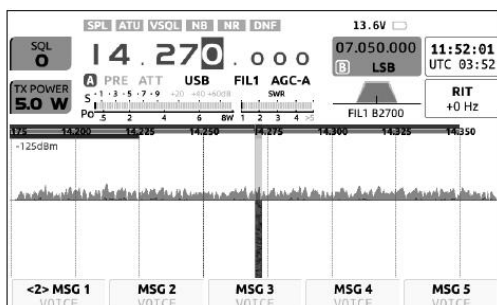

Preset recording list →

X6200 can pre-store 5 voice messages. These messages can be used for automatic transmission of voice mode. Click any MSG label to enter the editing interface, as shown below:

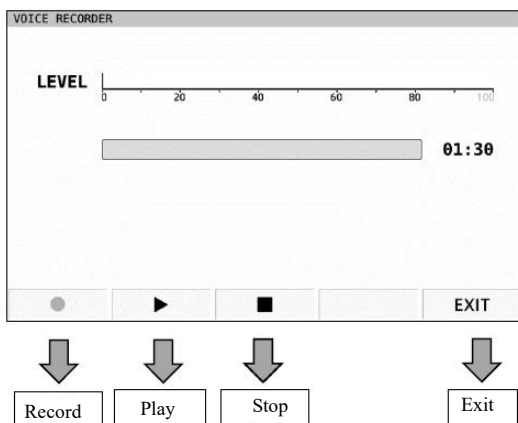

Icon function →

Recording operation method:

1. Pick up the hand microphone and keep it about 5~10cm away from the lips.
2. Press the "Record" key and start speaking at a normal volume until the speech is finished.
3. Press the "Stop" key to stop recording.
4. Press the "Play" key to listen to the voice just recorded.
5. Press the "EXIT" key to exit the current page.

### Attention!

- The maximum duration of each recording is 1 minute and 30 seconds.
- When recording, please turn off the monitoring function to avoid the echo. During daily use, the monitoring volume shall not be set too large, otherwise it may cause a sound echo.

## DFN function operation

1. Short press [DFN] to enter the menu on the first page of DFN options, as shown below:

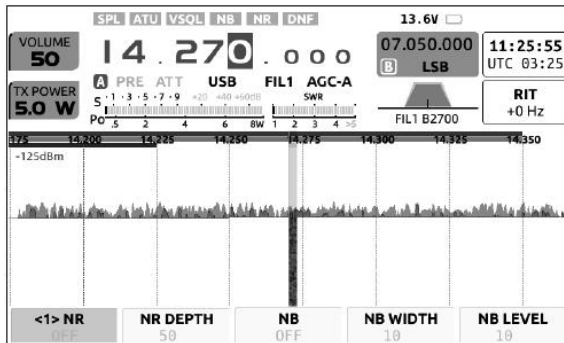

The function of menu <1> is defined as follows:

NR	NR DEPTH	NB	NB WIDTH	NB LEVEL
Noise reduction switch	Noise reduction depth	Pulse noise suppression	Pulse noise width	Pulse noise level

2. Press [DFN] again to enter the menu on the second page of DFN options.

The function of menu <2> is defined as follows:

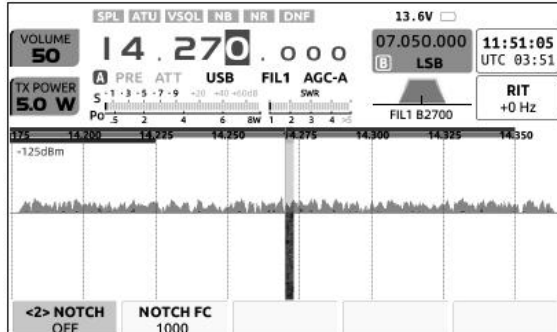

NOTCH	NOTCH FC	---	---	---
Notch filter	Notch frequency	---	---	---

## DFL function operation

Short press [DFL] to enter the DFL option menu, as shown below:

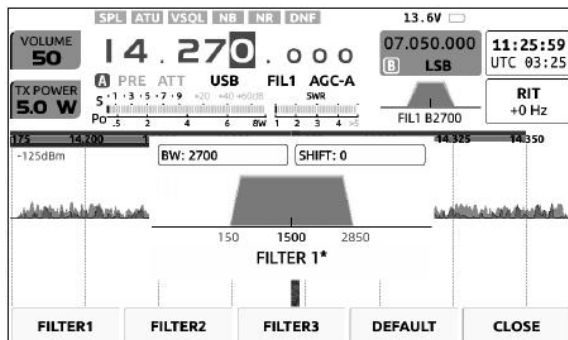

Operation method:

1. Select any filter from FILTER1~3 to enter.
2. Short press the MFK knob to switch and select different filter edges (red or blue trapezoidal box). The blue trapezoidal box is the high-cut filter (H-CUT), and the red trapezoidal box is the low-cut filter (L-CUT).
3. Rotate the MFK outer knob to adjust the parameters of the filter according to the actual use. After adjustment, the current filter parameters will be automatically stored in the corresponding filter label.
4. Short press [DEFAULT] to restore the filter parameters selected currently to the default parameters.
5. Short press [CLOSE] to exit the current interface.
6. The parameters of each filter bank differ with modes, and will be automatically switched in line with the current mode.
7. As shown in the figure above, the start frequency and cut-off frequency of the filter can be adjusted respectively to set the filter. The overlapping region of the two schematic trapezoidal filter graphs is the actual action range of the filter. The details are as follows:

### Filter composition diagram:

As shown in the figure on the right, the filter is acted by L-CUT and H-CUT together to form an effective filter bandwidth.

L-CUT controls the low boundary frequency and can effectively cut off the low frequency component;

H-CUT controls the high boundary frequency and can effectively cut off the high frequency component;

In daily use, it can be adjusted according to own habits to achieve the best listening effect.

#### Attention!

If the actual bandwidth of the filter is smaller than that of the useful signal, the useful signal will be completely cut off, resulting in no signal to be heard.

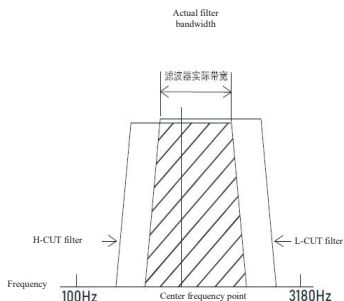

## Set time/view system information/update firmware/restore

### factory settings

SYSTEM SETTING				
TIME SETTING	SYSTEM INFO	FIRMWARE UPGRADE	WLAN	BLUETOOTH
WFSERVER	Language Settings			
FACTORY RESET				
				EXIT

#### Time setting method:

1. Entering [TIME SETTING] menu, rotate the MFK knob to select items of year, month, day, hour, minute, and time zone settings. Press the MFK knob to select the current option, rotate the large knob to adjust the number, and finally press MFK again to exit the current option.
2. After adjusting, rotate the MFK to select the "OK" button and press the MFK knob to confirm.

#### Attention!

- If it is set to local time, do not set the time zone.

#### View system information:

Rotate the MFK outer knob, select the [SYSTEM INFO] menu item, press the MFK knob to enter the project, and view the firmware version information.

#### Updating firmware:

When updating firmware, rotate the MFK knob, select the [FIRMWARE UPGRADE] menu item, press the MFK knob to enter, select the firmware that needs to be updated, press the button corresponding to [UPGRADE] to start updating.

#### Remote control:

Rotate the MFK outer knob, select the [WFSERVER] menu item, and press the MFK knob to enter the corresponding remote control settings.

*Please refer to Appendix 3 for specific settings.*

#### Restore factory settings:

**Attention!** Restoring factory settings will clear all your personalized settings.

1. Rotate the MFK knob, select [FACTORY RESET], press the MFK knob, and select.
2. Read the on-screen prompts and press the "OK" button twice to confirm reset.
3. After waiting for the reset to be completed, the X6200 will automatically shut down and turn on to complete the reset.

## Set wireless network parameters

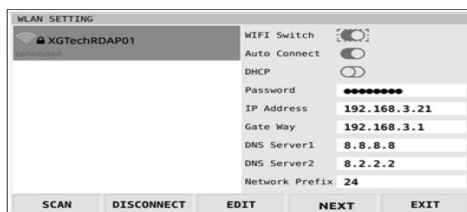

Key sequence: [GEN]---Via the multi-function key [SYSTEM] at the bottom of the screen, enter the system setting interface, and select the option WIFI.

Key description:

SCAN: Scan for nearby access points (Access Point)

CONNECT/DISCONNECT: Connect/ disconnect the access point selected in the list on the left

EDIT: Edit the element selected by the orange border on the right

NEXT: Select the next item with the orange border on the right side

EXIT: Exit

Operating instructions:

1. When entering the interface for the first time, press the [EDIT] button to turn on the WIFI switch.
2. Turn the MFK knob and select the wireless network to be connected in the left box.
3. Enter the necessary information in the information box on the right. The following three items must be entered correctly (key):
  - Password: Password
  - IP Address: Manually assign an IP address, with the same network segment as the wireless router.
  - Gate Way: Gateway address. The gateway address shall be the same as the network segment of the wireless router.
4. The DNS and Net Work Prefix options can be left blank by default.
5. After entering the correct configuration information, press the [CONNECT] button to connect to the network. After successfully connecting to the network, a green "connected" message will be displayed on the label of the currently connected wireless router on the left.
6. Press the [DISCONNECT] button to disconnect the current connection.
7. In the case of access to WIFI and Internet, the time server will automatically synchronize after a certain time. You can also manually synchronize it once.

### Note!

- Do not turn the MFK knob when entering the information, otherwise the information that has not yet been completely input will be lost.
- The configuration information will be automatically saved after connection. Configuration information for unsuccessful connections will not be saved.
- Some wireless routers that support advanced protocols and new frequency bands may be unable to connect and automatically allocate IP addresses. It is recommended that users manually assign the IP address of the device.

## Set Bluetooth function

The Bluetooth function can be connect peripheral devices such as Bluetooth keyboards, Bluetooth mice,for direct input of information , Operation of clicks, control, etc.

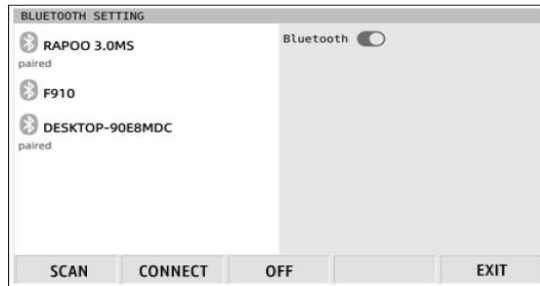

Operation sequence:

[GEN]---Via the multi-function key [SYSTEM] at the bottom of the screen, enter the system setting interface, and select the Bluetooth option.

Operating instructions:

OFF/ON: Turn on/off the Bluetooth adapter

SCAN: Scan surrounding Bluetooth devices

CONNECT/DISCONNECT: Connect/disconnect the Bluetooth device selected in the list on the left

EXIT: Exit

### Note!

1. When the Bluetooth adapter is on, it will continuously scan for surrounding Bluetooth devices.
2. When connecting the device, it will automatically pair without manually entering a PIN code.
3. If the device is turned off while connected via Bluetooth, Bluetooth will attempt to automatically connect again after the next power on.

## Forced shutdown

In case of abnormal startup/shutdown owing to startup failure, system crash or other factors, forced shutdown of the system can be performed as follows:

- Long press the switch button for more than 12s until the indicator light, screen, or sound are turned off.
- ❖ If the above forced shutdown method is still ineffective, you can unplug the external power supply and remove the battery board to directly power off the device.

## System downtime

In case of baseband or system downtime(screen,voice, etc.lag), and a red message flashes in the upper left corner of the spectrum, please directly unplug the external power supply, remove the panel, and force the device to power off. Then install the battery, plug in the external power supply, and start normally.

## Appendix 1

### Connection between X6200 and XPA125B (L4001 Cable)

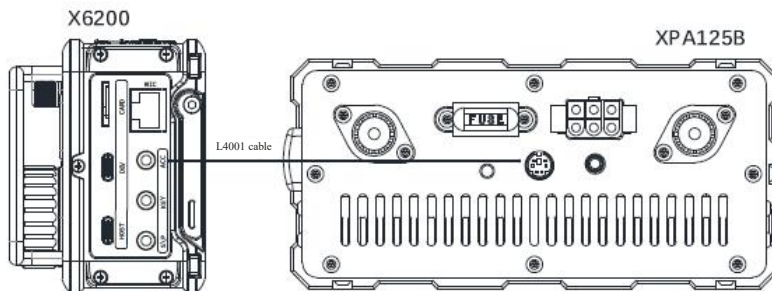

After the X6200 connects with XPA125B power amplifier and antenna tuner AIO through the L4001 cables, the output power can be expanded to 100W.

After connection, the X6200 can automatically control the wave band switching of XPA125B. Moreover, the ALC control will be built between two machines. When the X6200 output power exceeds the power limit of the XPA125B, the AACL control will automatically decrease the output power of the radio so that the output power of the XPA125B will be constant.

It is recommended that the output power of the X6200 be set to  $\leq 2W$ . Excessive input power will cause damage to the XPA125B.

#### ■ Attention!

IF XPA125B is not needed for power amplification, please unplug the ACC cable between the two machines, or keep XPA125B powered on and set PA and ATU to off. Otherwise, it will cause abnormal power output of the XPA125B.

- ◆ XPA125B power amplifier and L4001 cable need to be separately ordered.

## Appendix 2

### Connection between X6200 and Computer for Data Communication & Control

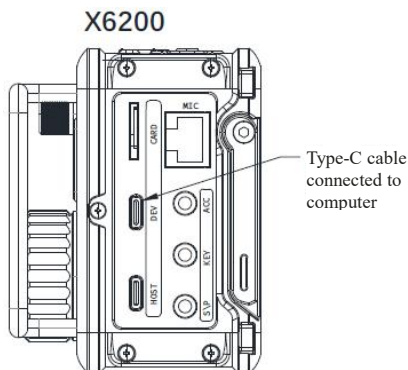

#### Connection method

1. As shown in the above figure, connect the Type-C cable to the DEV port on the right side of the X6200.
2. The CH342 port driver shall be installed, or the third party driver tool software can be used to install it online.
3. Select the model "XIEGU X6200" on the data communication software (or control software) to complete the connection.
4. Please choose the sound card virtualized by the host for sound input/output. It shall be noted that different sound devices are required for input and output.

#### Attention!

- If you choose other models compatible with CIV instructions, some instructions may not be responded to.

#### Connect to N1MM and automatically send CW

The connection method is the same as above, and the port is also connected to the DEV port on the right side of X6200. Once the settings for the N1MM end are configured, the X6200 can be controlled by a PC to send CW telegrams.

#### External mouse, keyboard, adapter device

External devices such as the mouse, keyboard and adapter can be used after being connected through the Host interface on the right side of the X6200.

- ◆ Note: The two USB ports of X6200 have limited power supply and cannot connect external USB-Hub devices.



## Appendix 3

### Setting method of radio end when using remote control software

#### WFSERVER

Operation method:

1. Rotate the MFK knob, select the [WFSERVER] menu item, press the MFK knob to enter the remote control setting interface, as shown in the following figure, and set according to the information in the figure:

WFSERVER SETTING (server stopped)				
RIG NAME	X6200			
USER NAME	user			
PASSWORD	123			
CTRL PORT	50001			
CIV PORT	50002			
AUDIO PORT	50003			
With wfview server from the wfview team: Elliott (W6EL), Phil (M0VSE), Roeland (PA3MET) and Jim (PABE). Source code available at wfview.org				
START	DEFAULT	CLEAR	SAVE	EXIT

2. After the configuration is completed, press the button corresponding to [START], wait a few seconds, and then complete the setting.
3. After the setting is completed, return to the main screen. A WF blue icon will be displayed in the upper right corner, indicating that the remote control function has been turned on, as shown in the following figure:

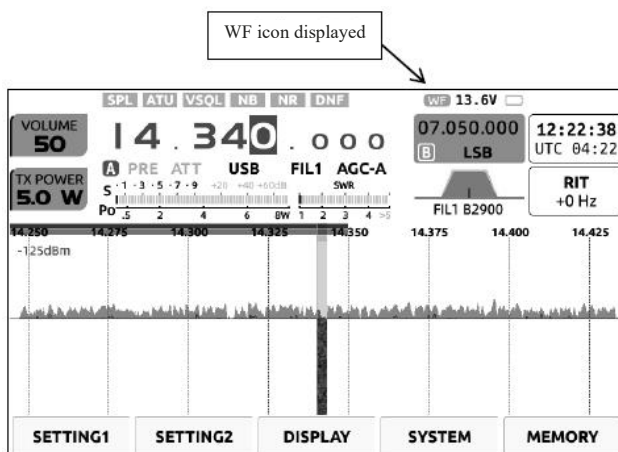

## Parameter

### Parameter Specifications

Frequency range: Receive:	0.5MHz~30MHz	50.00~54.00MHz
	88.0~108.0MHz	108.0~136.0MHz
Transmit:	1.8~2.0MHz	3.5~3.9MHz
	7.0~7.2MHz	10.1~10.15MHz
	14.0~14.35MHz	18.068~18.168MHz
	21.0~21.45MHz	24.89~24.99MHz
	28.0~29.7MHz	50.00~54.00MHz
Working mode:	CW, AM, SSB, FM,WFM (Receive only)	
Minimum step:	1Hz	
Antenna impedance:	50Ω	
Operating temperature range:	0℃~+50℃	
Frequency stability:	±1ppm in the 10min after startup @25℃: 1ppm/h	
Power voltage:	9.0~15.0VDC, negative electrode grounding	
Current consumed:	Receive: 650mA@ Max Transmit: 3A@ Max	
Body size:	About 200*89*51mm (L*W*H) (not including protrusions)	
Weight:	About 930g (only host)	

### Transmitter parameters

RF output power:	Max: 8W ±1dB @13.8VDC Max: 5W ±1dB (battery panel)
Spurious suppression:	≥50dB
Carrier suppression:	≥50dB
Microphone impedance:	200~10k (600Ω in general)

### Receiver parameters

Circuit type:	RF direct sampling
Sideband suppression:	≥50dB
MDS:	-138dBm
Sensitivity:	

Band \ Mode	SSB/CW	FM	AM	WFM/AM
0.5~1.799999MHz	/	/	10uV	/
1.8~1.999999MHz	0.20uV	/	10uV	/
2.0~27.999999MHz	0.20uV	/	2uV	/
28.0~30.000000MHz	0.20uV	0.20uV	2uV	/
50.0~54.000000MHz	0.20uV	0.20uV	2uV	/
<b>88~108MHz(WFM)</b>	/	/	/	Greater than 10uV
<b>108-136MHZ (AM)</b>	/	/	/	Greater than 10uV

(PRE=on, ATT=off, NB=off, NR=off, AGC=on)

Audio output: 0.5W (4Ω, ≤10% THD)

Audio output impedance: 4~16Ω

### Antenna tuner unit

Antenna tuner tuning impedance range: 20Ω~175Ω

Initial tuning time: ≤10s

Memory load tuning: ≤0.1s

- All specifications are typical and apply to amateur bands only. Due to technical improvements, the above specifications are subject to change without notice.
- The operating frequency range of transceivers sold in different countries or regions will be set according to local regulations. Ask local dealer for details.

### Packing List

Item name	Quantities
X6200 host	1 set
Type-C data line	1 pc.
H-22 hand microphone	1 pc.
Charging adapter	1 pc.
Power cord	1 pc.
Warranty card	1 copy
User Manual	1 copy
Certificate of conformity	1 copy (printed on the packaging box label)

# Elektro- und Elektronikgeräte

## Informationen für private Haushalte

Das Elektro- und Elektronikgerätegesetz (ElektroG) enthält eine Vielzahl von Anforderungen an den Umgang mit Elektro- und Elektronikgeräten. Die wichtigsten sind hier zusammengestellt.

### 1. Getrennte Erfassung von Altgeräten

Elektro- und Elektronikgeräte, die zu Abfall geworden sind, werden als Altgeräte bezeichnet. Besitzer von Altgeräten haben diese einer vom unsortierten Siedlungsabfall getrennten Erfassung zuzuführen. Altgeräte gehören insbesondere nicht in den Hausmüll, sondern in spezielle Sammel- und Rückgabesysteme.

### 2. Batterien und Akkus sowie Lampen

Besitzer von Altgeräten haben Altbatterien und Altakkumulatoren, die nicht vom Altgerät umschlossen sind, sowie Lampen, die zerstörungsfrei aus dem Altgerät entnommen werden können, im Regelfall vor der Abgabe an einer Erfassungsstelle vom Altgerät zu trennen. Dies gilt nicht, soweit Altgeräte einer Vorbereitung zur Wiederverwendung unter Beteiligung eines öffentlich-rechtlichen Entsorgungsträgers zugeführt werden.

### 3. Möglichkeiten der Rückgabe von Altgeräten

Besitzer von Altgeräten aus privaten Haushalten können diese bei den Sammelstellen der öffentlich-rechtlichen Entsorgungsträger oder bei den von Herstellern oder Vertreibern im Sinne des ElektroG eingerichteten Rücknahmestellen unentgeltlich abgeben.

Rücknahmepflichtig sind Geschäfte mit einer Verkaufsfläche von mindestens 400 m<sup>2</sup> für Elektro- und Elektronikgeräte sowie diejenigen Lebensmittelgeschäfte mit einer Gesamtverkaufsfläche von mindestens 800 m<sup>2</sup>, die mehrmals pro Jahr oder dauerhaft Elektro- und Elektronikgeräte anbieten und auf dem Markt bereitstellen. Dies gilt auch bei Vertrieb unter Verwendung von Fernkommunikationsmitteln, wenn die Lager- und Versandflächen für Elektro- und Elektronikgeräte mindestens 400 m<sup>2</sup> betragen oder die gesamten Lager- und Versandflächen mindestens 800 m<sup>2</sup> betragen. Vertreiber haben die Rücknahme grundsätzlich durch geeignete Rückgabemöglichkeiten in zumutbarer Entfernung zum jeweiligen Endnutzer zu gewährleisten.

Die Möglichkeit der unentgeltlichen Rückgabe eines Altgerätes besteht bei rücknahmepflichtigen Vertreibern unter anderem dann, wenn ein neues gleichartiges Gerät, das im Wesentlichen die gleichen Funktionen erfüllt, an einen Endnutzer abgegeben wird. Wenn ein neues Gerät an einen privaten Haushalt ausgeliefert wird, kann das gleichartige Altgerät auch dort zur unentgeltlichen

Abholung übergeben werden; dies gilt bei einem Vertrieb unter Verwendung von Fernkommunikationsmitteln für Geräte der Kategorien 1, 2 oder 4 gemäß § 2 Abs. 1 ElektroG, nämlich „Wärmeüberträger“, „Bildschirmgeräte“ oder „Großgeräte“ (letztere mit mindestens einer äußeren Abmessung über 50 Zentimeter). Zu einer entsprechenden Rückgabe-Absicht werden Endnutzer beim Abschluss eines Kaufvertrages befragt. Außerdem besteht die Möglichkeit der unentgeltlichen Rückgabe bei Sammelstellen der Vertreiber unabhängig vom Kauf eines neuen Gerätes für solche Altgeräte, die in keiner äußeren Abmessung größer als 25 Zentimeter sind, und zwar beschränkt auf drei Altgeräte pro Geräteart.

#### **4. Datenschutz-Hinweis**

Altgeräte enthalten häufig sensible personenbezogene Daten. Dies gilt insbesondere für Geräte der Informations- und Telekommunikationstechnik wie Computer und Smartphones. Bitte beachten Sie in Ihrem eigenen Interesse, dass für die Löschung der Daten auf den zu entsorgenden Altgeräten jeder Endnutzer selbst verantwortlich ist.

#### **5. Bedeutung des Symbols „durchgestrichene Mülltonne“**



Das auf Elektro- und Elektronikgeräten regelmäßig abgebildete Symbol einer durchgestrichenen Mülltonne weist darauf hin, dass das jeweilige Gerät am Ende seiner Lebensdauer getrennt vom unsortierten Siedlungsabfall zu erfassen ist.



# XIEGU

**Wireless Technology, Unlimited Creativity**



©Weisheng Communication

2018-2024

Edition Jul 2024

XDC-C01

[www.cqxiegu.com](http://www.cqxiegu.com)

The information in this manual may be updated with device firmware upgrades without prior notice.