



Palstar products are designed by Hams for Hams carrying on the Palstar tradition for high-quality products designed and manufactured in Ohio, USA.

LA-1K RF SENSING 1000W DUAL HF LDMOS AMPLIFIER

Specifications Summary

- 1000 watts PEP CW ICAS (160 m to 6m)
- RF Sensing Auto Band Switching
- Color TFT touch screen
- Variable speed fans
- 12.75" x 6.25" x 16.5"
- Weight: 27 lbs, 12.3 Kg

9676 N. Looney Rd,
Piqua, OH 45356 USA
(937) 773-6255
(800) 773-7931
(937) 773-8003 (Fax)
www.palstar.com



LA-1K RF SENSING 1000W DUAL HF LDMOS AMPLIFIER Technical Manual



Designed and Manufactured in the USA
Copyright 2018 Palstar, Inc.

LA-1K SPECIFICATIONS

- **SSB POWER:** Power levels up to 1000 Watts PEP
- **CW MODE:** 1000 Watts CW ICAS
- **FM/RTTY:** 500 watts
- **AM:** 275 watts
- **FREQUENCY RANGE:** 1.8 TO 54 MHz
- **DISPLAY:** Color TFT touch screen
- **INPUT DRIVE LEVEL:** 45W - 55W (All Bands) 40-55W (Typical)
- **OUTPUT:** 3 x RF SO-239 or Type N
- **ALC:** Exciter power control
- **GAIN:** 13dB + or -1dB (nominal)
- **RF SENSING:** Auto Band Switching without Band Data Cable from transceiver
- **RF OUTPUT:** Vacuum RELAY T/R Switching
- **POWER SUPPLY:** Internal Medical grade
- **AC POWER:** 100-125VAC 15A or 200-250VAC 10A
- **DC SUPPLY:** 50VDC @42A
- **POWER DEVICES:** 2 x 5600H 600W LDMOS
- **AUTO-PROTECT:** SWR/Short Circuit/Over Temp
- **COOLING:** Variable Speed Fans (3 speed)
- **INTERMOD:** Low IMD Distortion >-35dB
- **PURE SIGNAL:** Sample@+10dBm @1kW output (Rear Panel)
- **CHASSIS:** .090 ga. aluminium
- **TOP COVER:** .090 ga. aluminium, powder coated
- **DIMENSIONS:** 12.75" W x 6.25" H x 16.5" D
- **WEIGHT:** 27 LBS, 12.25 Kg
- **DESIGN CONCEPT:** Full compatibility with Palstar HF-AUTO autotuner
- **WARRANTY:** Two year

THEORY OF OPERATION

The LA-1K RF Sensing Dual HF LDMOS amplifier is a complete stand-alone amateur RF LINEAR amplifier.

It is completely independent of data from an external source to determine frequency for tracking from Band to Band. As a result of this feature, the LA-1K will function with any transmitting device without interconnecting data cable attachments.

The power output of the LA-1K is 1000 Watts PEP CW ICAS (Intermittent Commercial and Amateur Service). Under the ICAS classification, the use of the LA-1K is designed for transmissions that are of an intermittent nature.

Intermittent operation of the LA-1K implies that no operating or "ON" period of 1000W of Continuous Carrier Power will exceed approximately 1(ONE) minute. On Single Side Band (SSB) voice duty there is no limit on transmit time at full power of 1000W PEP.

Every "on" period must be followed by an "off" or standby period of at least the same or longer duration. The LA-1K provides a +10dBm@1kW RF tap feed at the rear panel to provide provisions for "PURE SIGNAL" operation provided by compatible transceivers. The level adjustment is calibrated at the factory. The LA-1K was designed to be fully compatible with the Palstar HF-AUTO automatic antenna tuner.

Included with the LA-1K:

- Two (2) line cords for 110VAC and 220VAC
- User Manual
- Amplifier unit
- Shipping box (please keep box for warranty repair, etc.)

As per FCC 15.21 changes or modifications not expressly approved by Palstar could void the user's authority to operate the equipment. No tune up procedure exists.

SCREEN DISPLAY ON POWER-UP

ON INITIAL POWER-UP

Display will indicate STBY mode (stand-by). To switch mode press the "MODE" button on the touchscreen display to switch into "OPR" mode (operational).

To change default POWER UP MODE push **MENU** then **NEXT** until **SELECT POWER UP MODE** displays at the top. Now select desired POWER UP MODE, **STANDBY**, or **LAST USED**, or **OPERATE**.

STAND-BY MODE

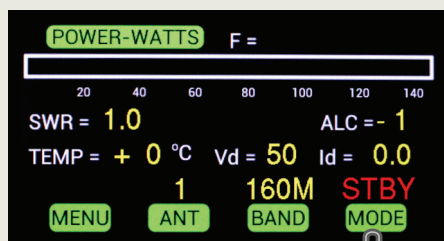

NOTE: Wattmeter only shows RED power bar graphical indicator when the LA-1K is producing power.

It is recommended that for power up mode "STBY" is selected to allow a **TUNE sequence** when using our HF-AUTO Antenna Tuner. After the HF-AUTO is tuned, push MODE to select "OPR" for operation mode.

OPERATIONAL MODE TRANSMITTING

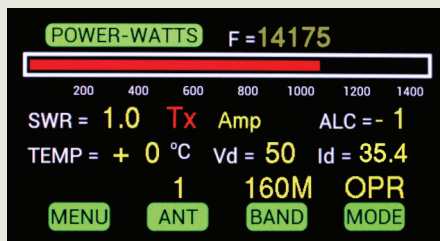

OPERATIONAL MODE

OPERATIONAL MODE

To switch into Operational mode "OPR" press the "MODE" button on the touchscreen display. The touchscreen menu will display "OPR" mode (operational). The red power bar graphical indicator will only be visible when transmitting.

OPERATIONAL MODE

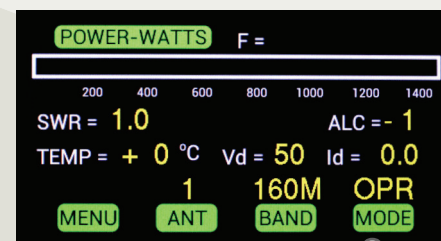

ADDITIONAL FEATURES

- Automatic band selection when user transmits
- Automatic antenna selection of last used antenna output when bands selected
- Over temperature protection by fan speed control, and bypass mode if temperature exceeds 100° C (fault temperature shows on display)
- Unit is locked in Bypass until temperature drops below 70° C
- **Frequency operation lock-out from 25.99MHz - 28.00MHz**
- Also see Page 5 and Rear Panel on Page 15.

OPERATIONAL MODE

BAND SELECT

To switch bands, 160M-80M-40-30M-20-15M-12-10M-6M, press the "BAND" button on the touchscreen display, then select desired band. The LA-1K selects the proper band automatically when transmit (PTT) is activated.

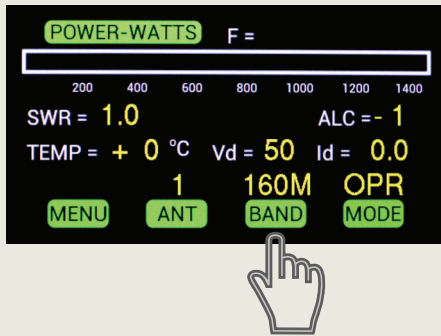

Select the BAND by pressing the corresponding numbers on the touchscreen display. A yellow arrow below the number of the BAND will indicate which BAND is selected. Press EXIT to return to main menu.

SELECT BAND



ANTENNA SELECT

To switch antennas between ANT 1 (Coax 1), ANT 2 (Coax 2), and ANT 3 (Coax 3), press the "ANT" button on the touchscreen display.



Then select desired antenna output. This setting will automatically select when changing bands to the last one used on any particular band. **The default value is ANT 1.**

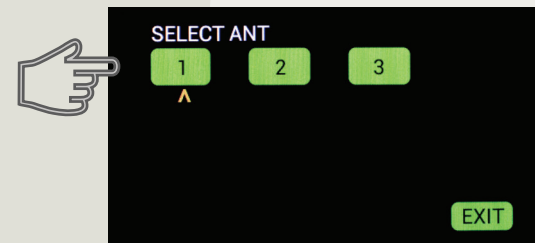

Select the antenna by pressing the corresponding number on the touchscreen display. A yellow arrow below the number of the antenna will indicate which antenna is selected. Press EXIT to return to main menu.

OTHER MENU OPTIONS

SELECT BACKLIGHT

To adjust the backlight on the touchscreen display press MENU.

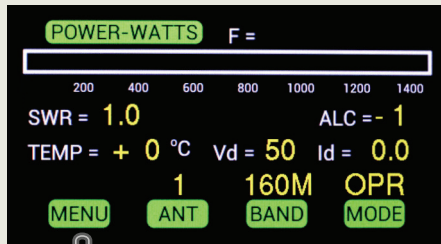

Press and hold the < or > arrows to adjust BACKLIGHT **LOW** (screen intensity when no buttons are pressed) and select NEXT and then < or > arrows to adjust BACKLIGHT **HIGH** (screen intensity when buttons are being pressed).

SELECT BACKLIGHT LOW/HIGH

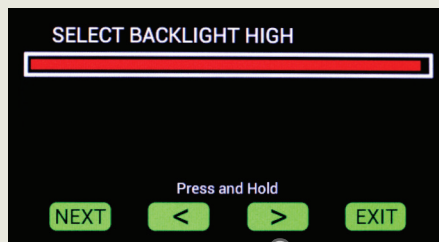
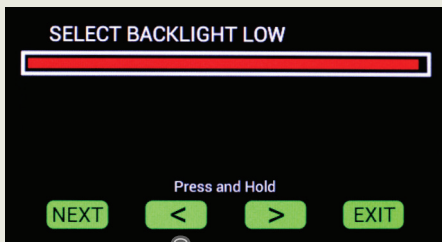

SELECT ALC BASE VALUE

To adjust ALC base value select menu on the touchscreen display.

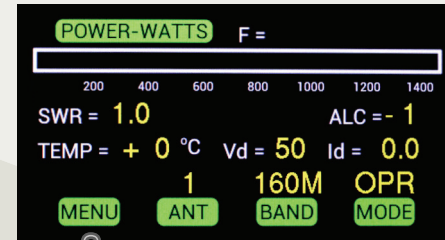

Press and hold the < or > arrows to increase or decrease ALC BASE VALUE. If using ALC this should be adjusted carefully to match your transceiver's requirements.

ALC BASE VALUE

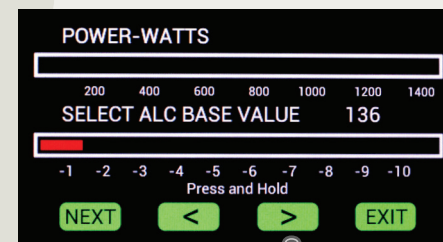

SSB POWER SET PROCEDURE



SSB

Power set procedure for **SSB** (see below for AM/FM)

- 1) Place transceiver in CW or RTTY (NOT AM or FM).
- 2) With LA1K in standby mode, key the transceiver and set for initial power level of about 30 watts, then unkey transmitter.
- 3) Switch the LA1K to Operate mode. Transmit and adjust transmitter output to achieve desired output power level. Do not exceed 1000 Watts output, or 60 Watts drive power (to avoid splatter). **UNKEY TRANSMITTER.**
- 4) Switch to desired operating mode. The peak power will be the same as it was on carrier mode, even though many wattmeters do not provide correct peak readings on SSB signals.

ALC ADJUSTMENT PROCEDURE

ALC

Suggested adjustment procedure for ALC

NOTE: Amplifier ALC is only used for SSB Voice transmission.

- 1) Connect ALC cable from transceiver to LA-1K amplifier.
- 2) Set ALC Base Value to Zero on amplifier.
- 3) Place transceiver in CW or RTTY (NOT AM OR FM).
- 4) With LA-1K in standby mode, set transceiver for initial power level of about 30 Watts, then unkey transmitter.
- 5) Switch the LA-1K to Operate Mode. Transmit and adjust transmitter output, to achieve desired output power level. Do not exceed 1000 Watts output, or 60 Watts drive power (to avoid splatter). **UNKEY TRANSMITTER.**
- 6) Switch transceiver to LSB or USB transmission. Transmit speaking in microphone and adjust the LA-1K ALC base value increasing the ALC voltage until the power output starts to drop. **The point where power drops slightly is the correct setting. Push EXIT on LA-1K.**

More precise adjustments may be made by connecting an oscilloscope to observe the output for clipping.

PREVENTING DAMAGE TO LA-1K

WARNING TO PREVENT DAMAGE

1. Never drive input power in **excess of 60 Watts**.
2. Never use a **tuning pulser** in CW full break-in mode. The LA-1K was **NOT** designed for full break in CW operation. Very high speed full break in keying which toggles the PTT line can lead to **amplifier damage**.
3. **Never block the air vents of the LA-1K**. Without proper airflow, excess heating of internal components may occur.

REQUIRED CONNECTIONS:

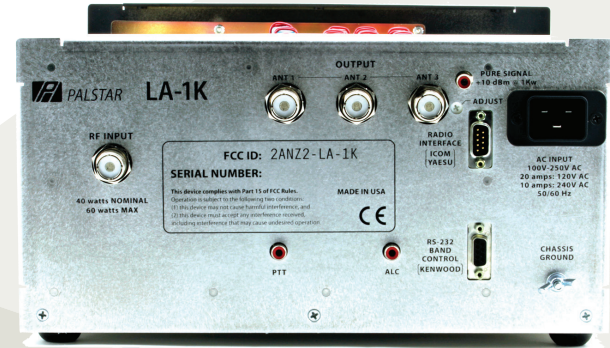

Rear Panel RF Deck Front Panel

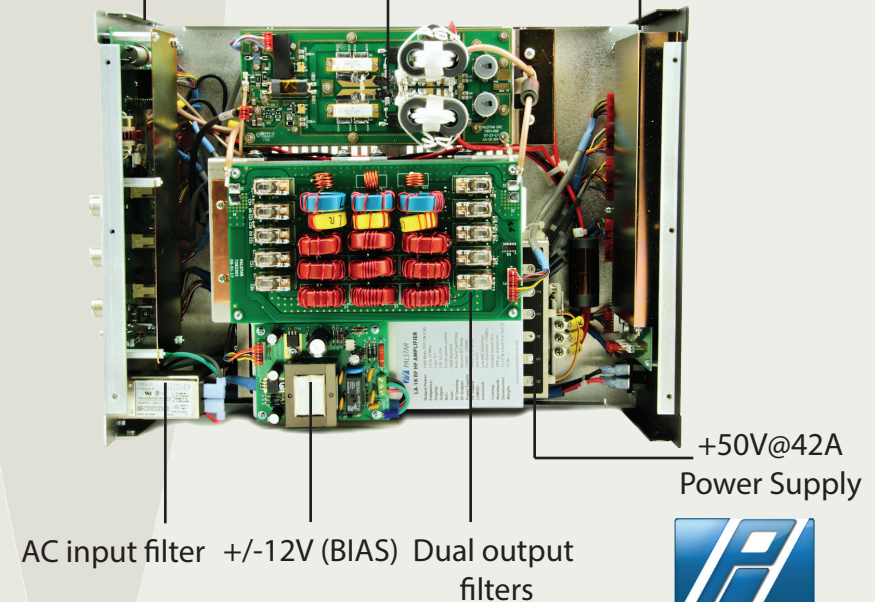

EXTERNAL DATA CONNECTORS

**Table of YAESU/ELECRAFT
Band selections and
4 bit BCD codes**

Band	DCBA	NC	12 volts
60m	0000	160m	7.0-8.0 volts
160m	0001	80m	6.0-7.0 volts
80m	0010	40m	5.0-6.0 volts
40m	0011	30m	0.0-1.0 volts
30m	0100	20m	4.0-5.0 volts
20m	0101	17/15m	3.0-4.0 volts
17m	0110	12/10m	2.0-3.0 volts
15m	0111	6m	1.0-2.0 volts
12m	1000		
10m	1001		
6m	1010		
NC	1111		

0 = low voltage (0 volts)
1 = high voltage (5 volts)

**Table of ICOM Band and
Voltage Level
Pin 5**

Band	12 volts
160m	7.0-8.0 volts
80m	6.0-7.0 volts
40m	5.0-6.0 volts
30m	0.0-1.0 volts
20m	4.0-5.0 volts
17/15m	3.0-4.0 volts
12/10m	2.0-3.0 volts
6m	1.0-2.0 volts

MARS Frequency Usage:

Range:	2.011 - 25.401 MHz
Power Level:	400 Watts
Emissions:	3K00J3E/J2D

The LA-1K automatically selects bands and it is normally **NOT** necessary to connect band data cables between your transceiver and the LA-1K amplifier.

RADIO INTERFACE CONNECTOR:

This connector is designed to be pin for pin compatible with other amplifiers. The required cables are widely available. They can be used to connect to ICOM and YAESU transceivers.

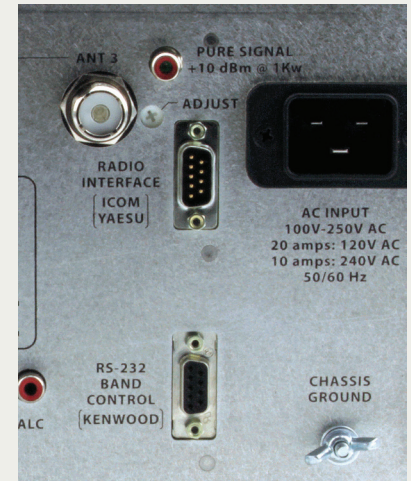

XCVR Interface [Radio Interface Pin Out]

Pin	Function
1	BCD B IN
2	BCD A IN
3	Kenwood RX (data in) [custom cable required]
4	Kenwood TX (data out) [custom cable required]
5	Icom Band Data
6	GND
7	Amp-Key IN
8	BCD D IN
9	BCD C IN

RS232 BAND CONTROL CONNECTOR:

This connector is designed to be used with Kenwood transceivers for band selection using a **null modem** adapter. It is also designed to control the amplifier from a computer.

HOW-TO UPDATE FIRMWARE

DOWNLOADING LA-1K FIRMWARE

- CREATE a folder on your computer's hard drive
- NAME the folder LA_1KFIRMWARE
- DOWNLOAD the Firmware file (Zip format) from the Palstar website, <http://www.palstar.com/en/la-1k/>. The download link is near the bottom of the page. The link to the file is named "LA-1K Firmware x.x"
- SAVE the file to the folder you created in Step 1
- OPEN the folder by right-clicking on the Zip file and select "Extract All" - follow the steps in the Extraction wizard
- CONNECT one end of the USB cable to a USB port on your computer.
- DOUBLE-CLICK "LOAD_LA-1K" within your LA_1KFIRMWARE folder that you created in Step 2.
- Follow the instructions on the opened computer window and use the "Browse" button to select the firmware version to be loaded.
- Depress and hold down the GREY button to the right of the USB port labeled "PROGRAM UPDATES" during the next two steps.
- CONNECT the other end of the USB cable to a USB cable to the LA-1K front panel. A "Found 1 device" message will appear on the right side of the opened computer window.
- TURN-ON the LA-1K.
- Release the GREY button on the LA-1K front panel.
- Click on the "Update Firmware" button that is on the opened computer window. Wait until the green bar in the middle of the computer window shows that the programming completes by filling from left to right. The firmware version number on the LA-1K is on the bottom line of the start up screen.

LA-1K FIRMWARE SUMMARY

SEE WEBSITE FOR FIRMWARE SUMMARY:

<http://www.palstar.com/en/la1k/>

POWER SUPPLY PERFORMANCE

If the LA-1K is used on **120VAC** the max current rating is 33A. The DRIVE LEVEL on some of the bands may need to be reduced.

If the current exceeds 33 Amps, the power supply will shut down and the Vd reading on the TFT display will read ZERO; "BYPASS + Vd" shows on display; (operation@120 VAC).

The power supply will immediately come back on in 1 to 2 seconds and the display will read 50V again. Reducing drive will prevent this from occurring.

The medical grade power supply will not be damaged as this feature has been designed into the power unit of the LA-1K.

For 230-250 VAC operation at full power of 1000W PEP is available on all bands. It is recommended that **240VAC** be used for all modes.

AM/FM Power Set Procedure

For AM or FM power levels must be adjusted in that mode. For AM mode set carrier no higher than 275 Watts. AM requires peak power of 4 times carrier level.

TROUBLESHOOTING

Transmit Fault Indications

Bypass SWR: [as seen on display]

Amp is in BYPASS to protect from high SWR. This indication shows up whenever SWR is, (or has been) over 2.5:1 during a transmission. Transient faults such as antenna arcing can show a low SWR after the fault event, while transmitter is still keyed up.

Solution:

- 1) Make sure correct LA-1K antenna connector is selected.
- 2) Verify that your HF-AUTO or other tuner has obtained a good match while amp is in standby. Attempting Auto tuning at high power can cause this "Bypass SWR" alert.

With some autotuners it may be necessary to select manual mode after obtaining a low SWR to prevent unwanted tuning in the middle of your transmission.

- 3) If antenna arcing or loose connection is suspected, try the amplifier on a dummy load. If it works normally, there is likely some type of intermittent SWR problem.

Bypass TEMP: [as seen on display]

Amp is in BYPASS to protect from high temperature. Temperature will show in red when temperature exceeds 71 degrees C. When the heatsink temperature exceeds 100 degrees C. "**Bypass Temp**" will show on the display. (Amplifier locked in Bypass)

Solution:

Allow time for the heatsink to cool down to below 70 degrees C.

Operate mode will automatically return. Verify that nothing is blocking proper airflow through the side vents.

Note: High SWR, or prolonged transmission in carrier modes, may cause elevated temperature.

Bypass+VD: [as seen on display]

Amp is in **BYPASS** to protect from loss of +50V, drain voltage supply. The indication should clear in a few seconds. This occurs **when operating on 120V**, if Drain Current (Id) exceeds **32 Amps**.

Solution:

Switch supply voltage to **240V**, or If operating on 120V, Reduce Drive Power.

TROUBLESHOOTING

TX Wait: [as seen on display]

This shows on display when the PTT Line is grounded but **NO RF** is present. RF must be applied with **PTT line** low to key the amplifier to the transmit state.

Other Issues:

Won't amplify or autoband switch when transmitting.

Solution:

Make sure that the PTT cable is connected to the transceiver. This is a **REQUIRED** connection. Note that **"TX"** will show on display whenever the **PTT** connector sees a ground. Some transceivers must have their PTT keying output enabled in the **transceiver's menu settings**.

Low SWR on transceiver, high SWR on LA-1K

This problem arises when you observe Low SWR on transceiver, but the LA-1K shows High SWR.

Solution:

Always **disable** (i.e. Bypass) **the autotuner in your transceiver** when driving any amplifier.

The transceiver's autotuner can not match loads connected to the amplifier's output.

NORMAL MODE LA-1K KEYING

Starting with Firmware V1.03H:

Added New Menu Option: "NORMAL or DIRECT KEYING"

In **"NORMAL MODE"** the amplifier RF Sensing switches bands automatically before relay keying occurs (as follows):

When the transceiver keys, the amplifier RF Sensing MUST see RF to detect frequency and switch bands before keying. It does NOT key up in "direct response" to the PTT line but requires RF to be applied as well.

Each time the PTT line goes low, the amplifier repeats the same sequence again. Total time required is around 20 milli-seconds. During this time, the two relays transition from receive, to transmit.

If operating on SSB mode, the rise time of the RF drive is fairly slow, therefore this relay switching results in very little reflected RF power.

In some digital modes, (or full break-in CW), the RF reaches full power just about instantly, so the relay transition is seen as a 2.5 milli-second SWR spike (as the 2 relays transition from receive to transmit).

This is NOT harmful to modern transceivers, at only 40 Watts output. Direct Keying mode (Below) may be selected to prevent this transient from occurring.

TYPICAL KEYING EXAMPLES

NORMAL MODE LA-1K KEYING

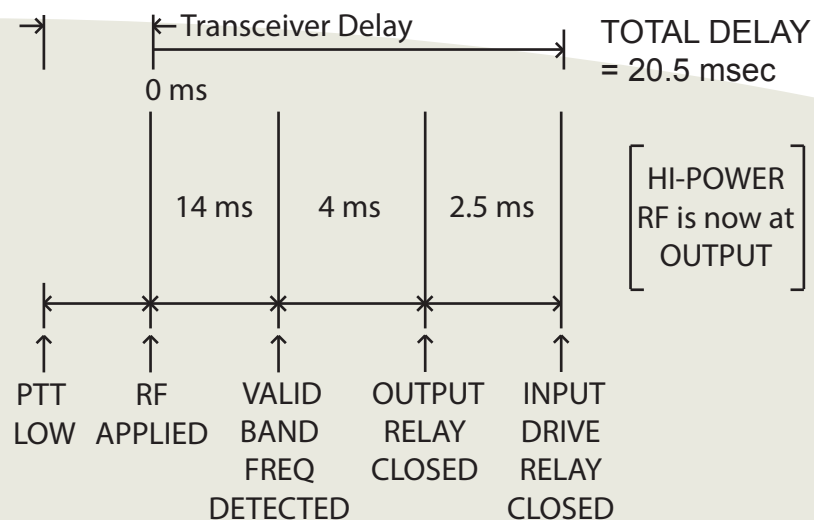

HOW KEYING WORKS:

- 1) The amplifier won't close its transmitting output relay until it gets a solid frequency reading and switches bands. This requires 14 milliseconds of RF being applied.
- 2) The output relay then closes requiring 4 milliseconds to close. We are now at 18 milliseconds.
- 3) The input relay now closes, (it was energized 2 milliseconds after the transmit relay) This adds 2.5 milliseconds delay. (Hi Power RF now appears at output). Total delay is around 20.5 milliseconds.

DIRECT MODE LA-1K KEYING

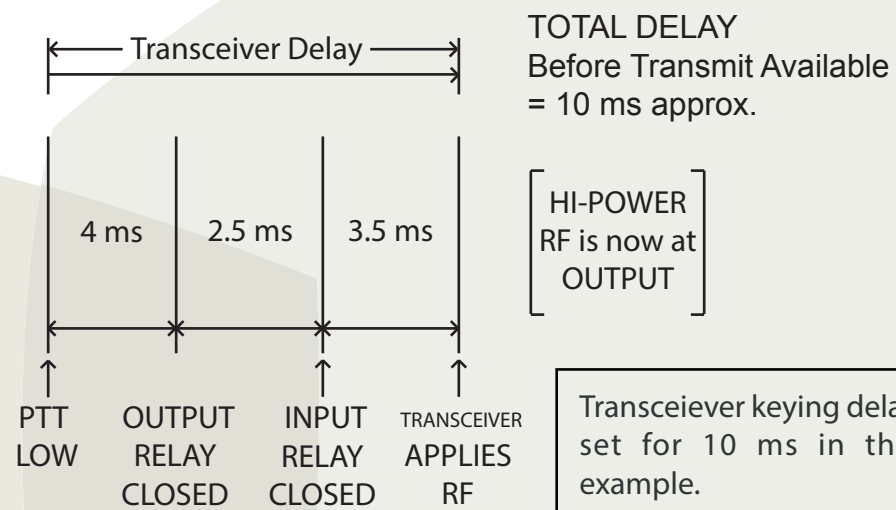

Selection of "DIRECT KEYING" mode closes the LA-1K transmit relays in direct response to the PTT line. This way, the transceiver's built in transmit RF delay ensures enough time for the relays in LA-1K to be in transmit position before RF is applied. Around 6 milli-seconds is required for relay closing, so if adjustable, transceiver keying delay should be set higher than 6 msec.

Please note: A band data cable is required in this mode. The LA-1K reverts to normal keying without the band data cable connected.