



**Palstar Incorporated**  
9676 N. Looney Rd.,  
Piqua, OH 45356 USA

**Customer Service and Sales Telephone:**

1-800-773-7931

**Fax:**

1-937-773-8003

**Email:**

info@palstar.com



## ***BT1500A 1500 Watt Balanced Antenna Tuner***

# ***Owner's Manual***



© Copyright 2006-2010 Palstar, Inc.  
Printed in the U.S.A.

**WARNING: TO PREVENT FIRE OR ELECTRICAL SHOCK DO NOT EXPOSE TO RAIN OR MOISTURE**



An appliance and cart combination should be moved with care. Quick stops, excessive force and uneven surfaces may cause the appliance and cart combination to overturn.

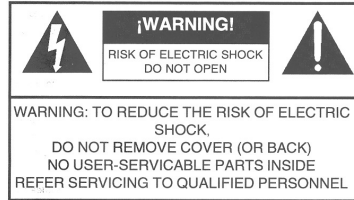

The lightning flash with arrow head symbol, within an equilateral triangle, is intended to alert the user to the presence of uninsulated "dangerous voltage" within the product's enclosure that may be of sufficient magnitude to constitute a risk of electric shock to persons.



The exclamation point within an equilateral triangle is intended to alert the user to the presence of important operating and maintenance (servicing) instructions in the literature accompanying the appliance.

**WARNING: TO REDUCE THE RISK OF FIRE OR ELECTRIC SHOCK, DO NOT EXPOSE THIS APPLIANCE TO RAIN OR MOISTURE. DO NOT OPEN THE CABINET WHILE OPERATING. REFER SERVICING TO QUALIFIED PERSONNEL ONLY.**

**CAUTION: TO PREVENT ELECTRIC SHOCK, DO NOT USE THE THREE WIRE CORD WITH AN EXTENSION CORD RECEPTACLE OR OTHER OUTLET UNLESS THE BLADES CAN BE FULLY INSERTED TO PREVENT BLADE EXPOSURE.**

**1. Read Instructions**—All the safety and operating instructions should be read before the appliance is operated.

**2. Retain Instructions**—The safety and operating instructions should be retained for future reference.

**3. Heed Warnings**—All warnings on the appliance should be adhered to.

**4. Follow Instructions**—All operating and use instructions should be followed.

**5. Cleaning**—Unplug this appliance from the wall outlet before cleaning. Do not use liquid cleaners or aerosol cleaners. Use a damp cloth for cleaning.

**6. Do Not Use Attachments**—not recommended by the manufacturer or they may cause hazards.

**7. Water and Moisture**—Do not use this product near water—for example, near a bathtub, wash bowl, kitchen sink, laundry tub, in a wet basement, or near a swimming pool—and the like.

**8. Accessories**—Do not place this product on an unstable cart, stand, tripod, bracket, or table. The product may fall, causing serious injury to a child or adult, and serious damage to the appliance.

**9. Ventilation**—This product should never be placed near or over a radiator or heat register. This product should not be placed in a built-in installation such as a bookcase or rack unless

proper ventilation is provided or the manufacturer's instructions have been adhered to. Any slots or openings in the cabinet are provided for ventilation. To ensure reliable operation of the video product and to protect it from overheating, these openings must not be blocked or covered. The openings should never be blocked by placing the product on a bed, sofa, rug, or other similar surface.

**10. Grounding or Polarization**—this product is equipped with a 3-wire line cord receptacle. It is intended for use with a 3-wire properly grounded power socket. Do not defeat the safety purpose of the supplied line cord and plug.

**11. Power Sources**—This product should be operated only from the type of power source indicated on the marketing label. If you are not sure of the type of power supplied to your home, consult your appliance dealer or local power company.

**12. Power-cord Protection**—Power-supply cords should be routed so they are not likely to be walked on or pinched by items placed upon or against them. Pay particular attention to cords at plugs, convenience receptacles, and the point where they exit.

**13. Lightning**—For added protection for this product during a lightning storm, or when it is left unattended and unused for long periods of time, unplug it from the wall outlet.

### Limited Warranty

Palstar Inc. warrants products manufactured by it to be free from defects in material and workmanship under normal use and service **for a period of one (1) year from the date of delivery to the first buyer** (the "Warranty Period"). Palstar Inc's obligation under this warranty is limited to repair or replacement of the product; at its option at the Palstar factory in Piqua, OH.

Effective only when the product is returned to the factory with all transportation charges prepaid and examination of the product discloses in Palstar's judgment, to have been defective during the Warranty Period.

The Warranty Period shall not extend beyond its original term with respect to interim in-warranty repairs by Palstar. This Warranty Period shall not apply to any product which has been repaired or altered by anyone other than Palstar without prior written authorization. Warranty does not extend to any products which have been subject to damage from improper installation, application or maintenance in accordance with the operating specification. Palstar neither assumes nor authorizes any person to assume for it any obligation or liability other than herein stated.

### Repair Policy

When sending in a product for service, please "double" box it carefully and ship it insured for your protection. Please include a note clearly describing the problem, how you wish the item returned and how you wish to pay for the service. Package your unit properly. Palstar, Inc. is not responsible for merchandise damaged in shipment. Our service rate is \$30 per hour (1/2 hr. minimum).

### Return Policy

All returns must receive prior authorization from Palstar. Returned items must be received in original—AS SHIPPED—condition including the original box, manuals, accessories, and copy of sales receipt. Returns must be within 14 days of purchase. Returned items are subject to a 25% restocking fee. Shipping is not refundable.

## Front Panel Indicators and Controls

<b>Metering</b>	Dual movement cross needle power and SWR meter
<b>Controls</b>	
Capacitor	Dual Section Capacitor: 960pF & 65PF @ 4.5kV
Inductance	Dual 22 $\mu$ H roller inductors: 12 ga. wire wound on steatite ceramic core, silver plated shaft and wheel
Wattmeter Range Switch	2 position 300 W /3000 W
Other controls:	Low Pass (Hi - Z) / High Pass (Lo - Z) switch Hi - C / Lo - C switch Peak/Average Metering Peak Hold Metering

## Rear Panel Connectors

RF INPUT	SO239 chassis connector
Balanced Line Output	Dual High Voltage Nylon66™ terminal posts
9-12 VDC Input @ 200ma	2.1 mm connector (center positive). AC Power Adaptor supplied (U.S. only)

## Other

Frequency Coverage	1.8 — 29.5 MHz
Power Maximum	1500 W PEP SSB, 1000 W single tone continuous
Impedance Range (assuming Resistive load)	2500 +/- j2500 160 m to 20 m 1000 +/- j1000 17m to 10m
Input balun	1:1 current type balun
Dimensions	6" H x 13" W x 16" D (incl. terminals)
Weight	17 lbs.
Materials	Chassis and top cover is 11 ga. (.090) aluminum that has been chem-film treated in gold color. Front panel and cover powder coated.

**14. Power Lines**—An outside antenna system should not be located in the vicinity of overhead power lines, other electric light or power circuits, where it can fall into such power lines or circuits. When installing an outside antenna system, extreme care should be taken to keep from touching such power lines or circuits as contact with them may be fatal.

**15. Overloading**—Do not overload wall outlets and extension cords as this can result in a risk of fire or electric shock.

**16. Object and Liquid Entry**—Never push objects of any kind into this product through openings as they may touch dangerous voltage points or short-out parts that could result in a fire or electric shock. Never spill liquid of any kind on the product.

**17. Servicing**—Do not attempt to service this product yourself as opening or removing covers may expose you to dangerous voltage or other hazards. Refer all servicing to qualified service personnel.

**18. Damage Requiring Service**—Unplug this product from the wall outlet and refer servicing to qualified service personnel under the following conditions:

- When the power-supply cord or plug is damaged.
- If liquid has been spilled, or objects have fallen into the product.
- If the product has been exposed to rain or water.
- If the product does not operate normally by following the operating instructions. Adjust only those controls that are covered by the operating instructions. An improper adjustment may result in damage and will often require extensive work by a qualified

technician to restore the product to its normal operation.

- If the product has been dropped or the cabinet has been damaged.
- When the product exhibits a distinct change in performance—this indicates a need for service.

**19. Replacement Parts**—when replacement parts are required, be sure the service technician has used replacement parts specified by the manufacturer or have the same characteristics as the original parts. Unauthorized substitutes may result in fire, electric shock or other hazards.

**20. Safety Checks**—Upon completion of any service or repairs to this product, ask the service technician to perform safety checks to determine that the product is in proper operating condition.

**21. Outdoor Antenna Grounding**—Before attempting to install this product, be sure the antenna or cable system is grounded so as to provide some protection against voltage surges and built-up static charges.

- Use No.10 AWG copper, No.8AWG aluminum, No.17AWB copper-clad steel or bronze wire or larger, as ground wire.
- Secure antenna lead-in and ground wires to house with stand-off insulators spaced from 4 feet to 6 feet apart.
- Mount antenna discharge unit as close as possible to where lead-in enters house.
- A driven rod may be used as the grounding electrode where other types of electrode systems do not exist. Refer to the National Electric Code, ANSI/NFPA 70-1990 for information.
- Use jumper wire not smaller than No.6 AWG copper or equivalent, when a separate antenna grounding electrode is used.

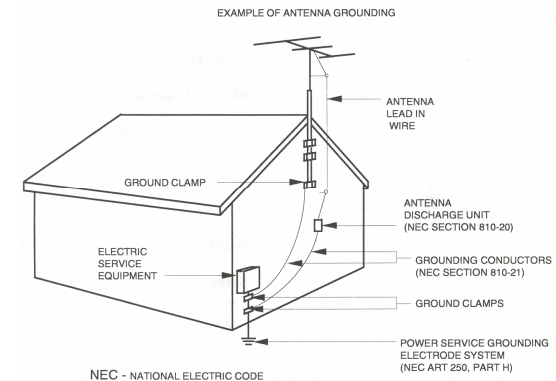

## 4 Table of Contents

Thank you for purchasing a Palstar BT1500A Antenna Tuner. This antenna tuner has been designed and manufactured to high quality standards, and will provide reliable operation for many years.

Please carefully read the Owner's Manual in order to take advantage of the many interesting features that will provide years of enjoyable amateur radio operation.

<b>Important safeguards</b>	<b>2</b>
<b>General Description</b>	<b>5</b>
<b>Installation</b>	<b>6</b>
Unpacking	6
Location	6
Installation Procedures	6
Rear Panel Connections	7
<b>Front Panel Description</b>	<b>8-9</b>
<b>Schematic Diagram</b>	<b>10-11</b>
<b>Operating Your BT1500A</b>	<b>12</b>
Before Operating	12
Tuning	12
Notes	13
<b>Understanding Your Tuner</b>	<b>14</b>
<b>Specifications</b>	<b>18</b>
<b>Service and Warranty</b>	<b>19</b>

## Understanding Your Tuner 17

system of switches. Knife switches work very well for parallel transmission line,

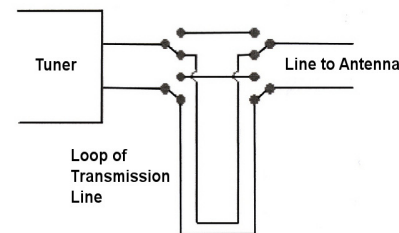

since they will handle the high voltages that may be present on parallel transmission lines. As with any run of parallel transmission line, you must keep the line free and clear of metallic objects. As well, do not coil the line itself. Instead, make a single large loop.

The size of the loop depends on the frequency of operation and how much further along the line you must go to obtain an impedance value that falls within the tuner limits.

It is possible to calculate favorable line lengths for each band for any combination of antenna and feedline. The very large variety of antennas and the many types of feedlines used by amateur operators place such calculations outside the scope of these notes. Most operators find it quicker to experiment with various line lengths until they uncover the right combinations for each band.

The balanced L-network, the transmission line, and the antenna form a total system that is very flexible. The initial inability to find a 1:1 SWR match for the system is not a fault of any of the three major components. Instead, the situation is a normal function of the dynamics of the antenna feedpoint impedance and its transformation along the transmission line. You may alter any of the three components of the system to arrive at an impedance at the antenna terminals that the tuner can match. In most cases, but not all, modifying the transmission line length is the easiest technique. Alternatively, you may alter the antenna length as well.

There are many resources available for learning more about your antenna and feedline system. The *ARRL Antenna Book* is a good place to start. In addition, there are numerous aids to making calculations of what is occurring in the system.

The more that you know about your antenna and feedline system, the more effectively you will be able to use your Palstar BT1500A tuner.

higher if the impedance has a reactive component.

**Your Antenna and Feedline:** The balanced L-network can be used with any antenna fed with parallel feedline. Parallel feedlines may range from 300 Ohm TV twin lead, to “windowed” lines in the 400—450 Ohm range, to 600 Ohm (and higher) ladder lines. The applicable types of antennas include flat-top and Vee’d all-band doublets, horizontally or vertically oriented loops, end-fed wires, and arrays such as the lazy-H and the 8JK. There are also a number of designs for wire Yagis and quad beams that employ parallel transmission lines.

At any given operating frequency, the antenna has a certain feedpoint impedance. For most multi-band antennas, the feedpoint impedance will change with the operating frequency. On most bands, the impedance will be complex, that is, a combination of resistance and reactance. However, unless your feedline happens to be an exact multiple of a half wavelength (accounting for the line’s velocity factor) or unless the feedpoint impedance is identical to the characteristic impedance of the feedline, your antenna tuner will not encounter the antenna feedpoint impedance.

For any condition where the feedpoint impedance does not exactly match the characteristic impedance of the feedline, the impedance will vary continuously along the feedline, returning to the feedpoint value at every half wavelength along the line. The precise values that you will encounter at some specific point along the line depend upon the characteristic impedance of the line, its velocity factor, and the feedline impedance itself. The range of variation in both resistance and reactance is a function of the degree of difference between the feedpoint impedance and the characteristic impedance of the feedline.

Many users of multi-band antennas are surprised to learn that even very high feedpoint impedances can result in very low impedances at certain regions along the feedline. An end-fed wire at any frequency, or a center-fed wire that is close to a multiple of a wavelength long will present a very high impedance. If your feedline is the right length, you may find that the impedance at the antenna terminals is very low. Alternatively, at other lengths, you may discover that the reactance at the antenna terminals is outside the range for which the output capacitor can compensate. Without careful computation, you may not know which condition applies. You may only know that the tuner seems unable to provide 1:1 SWR for the line to the transmitter.

**A Simple Work-Around:** There are many ways to correct the problem of being unable to effect a good match on one or more bands of operation when using a balanced feedline. One of the simplest and cheapest techniques is to insert extra feedline into the length from the tuner to the antenna. Since the losses on the parallel line are very low, a few extra feet of transmission line will not be detectable by the station you are working.

The sketch shows the general idea. You can insert the loop manually or with a



The Palstar BT1500A Antenna Tuner is an American made impedance matching network.

The BT1500A optimizes the performance of your antenna and transmitter by providing adjustable impedance matching using balanced dual tandem roller inductors with a shunt capacitor that can be switched to the input (transmitter) side or the output (antenna) side.

The BT1500A also measures the power and Voltage Standing Wave Ratio (VSWR or SWR) which allows you to tune the SWR to the lowest ratio possible for the selected transmission frequency.

A switch allows the user to choose Average or Peak metering. Also, a Peak Hold function holds the peak reading for approximately 2 seconds for easier reading.

Front panel controls allow for

selection between two ranges of variable capacitance, and allow the shunt capacitor to be switched between the input (transmitter) side (low Z, high pass) and the output (antenna) side (high Z, low pass).

Tuning is achieved with the front panel controls. The Vernier capacitor dial allows for fine tuning with precision and accuracy, while the Inductor crank handle provides coarse adjustments.

The range of the power meter (300W/3000W) is selected by a push button switch located on the front panel.

### Unpacking

Carefully remove the BT1500A from the shipping carton and inspect it for signs of damage. If any damage is apparent, notify the transportation carrier or dealer immediately. **We recommend keeping the packing carton for moving, storing or reshipping the tuner to us for repair if required.**

### Location

Select a location for the BT1500A that allows the connectors to be free from any possible contact with people, pets or objects during operation, and with unrestricted air flow for cooling.

### Installation Procedures

Connect a coax cable from your transmitter to the RF INPUT connector on the rear panel. Keep the cable as short as possible. If you use a linear amplifier, connect your transmitter to the linear amplifier input and the linear amplifier output to the BT1500A.

Connect your balanced antenna feedline to the upper white Nylon66™ BALANCED OUTPUT posts on the back panel.



**WARNING: Balanced antennas will produce high RF voltages at the output post connectors. RF burns may result if touched during transmission.**

two equal series portions, one in each leg of the network. The shunt capacitor has the same value in both versions of the L-network.

Unlike the single-ended L-network, the legs of the balanced L-network are both above ground potential. Hence, both the input and antenna sides of the network are balanced. In order to accommodate the single-ended transmission line from the transmitter, the tuner places a 1:1 choke (current) balun between the input side of the network and the transmitter coax connector. The balun converts the unbalanced input from the transmitter to a balanced condition for the network. As well, it suppresses currents that might otherwise appear on the braid of the transmitter cable.

**Limitations:** Every antenna tuner, no matter what the type, has limits to the range of impedances that it will match to the 50 Ohm input. The balanced L-network is no exception. Understanding those limitations will help you to effect a match on every band.

The impedance presented to the tuner antenna terminals is usually expressed as a series combination of resistance and reactance, that is,  $R \pm jX$  Ohms. The L-network that places its shunt capacitor on the antenna side is normally an up-converter. The limiting lower end impedance is in the vicinity of 60 to 100 Ohms resistive for a 50 Ohm input. The upper limit of impedance that the network will match is a complex function of frequency, the component values, and the amount of reactance that is part of the impedance at the tuner terminals. For most of the HF Amateur bands, the upper impedance limit of the balanced L-network in the Palstar BT1500A tuner is about  $2500 \pm j2500$  Ohms. This upper limit descends slowly with rising frequency so that at 30 MHz the upper limit is about  $400 \pm j400$  Ohms. The decrease in range results from the unavoidable minimum capacitance of the output variable capacitor.

The impedance presented to the antenna terminals may be any value of R and any value of X. For a given R component, the tuner will require a certain setting of the coil and also the capacitor. If there is reactance at the antenna terminals, then the network requires a lower value of C if the reactance is capacitive, and a higher value of C if the reactance is inductive. The network compensates for the reactance by increasing or reducing the capacitive reactance required for a purely resistive load with only small changes in the required inductance. The amount of compensation available is a function of the maximum and minimum values of shunt capacitance and the resulting reactance of this component. With finite components, the range of reactance for which the network can compensate is always limited.

As well, every matching network incurs losses within the network, mostly as a function of the Q of the inductor and the ratio of the antenna terminal impedance to the input impedance. For the balanced L-network with a shunt output capacitor, the higher the impedance to be matched, the higher the losses. The losses will be lower if the reactance at the antenna terminals is purely resistive and

## 14 Understanding Your Tuner

### Understanding Your PALSTAR BT1500A Tuner and Your Antenna

The PALSTAR BT1500A antenna tuner is a highly flexible matching device intended for use with antennas that use balanced or parallel transmission lines. To obtain the best performance from the tuner, you should understand how the tuner works and how it relates to your antenna and feedline.

**Basic Operation:** Examine the schematic diagram of your tuner to see all of the electronic features. In this discussion, we shall focus only upon the matching network itself. The basic circuit under discussion is a balanced L-network with the shunt capacitor on the output side.

#### Single-Ended L\_Network

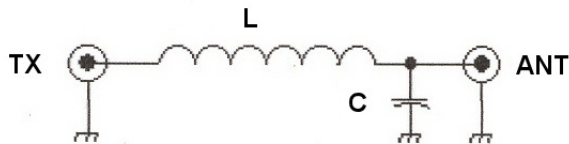

#### Balanced L-Network

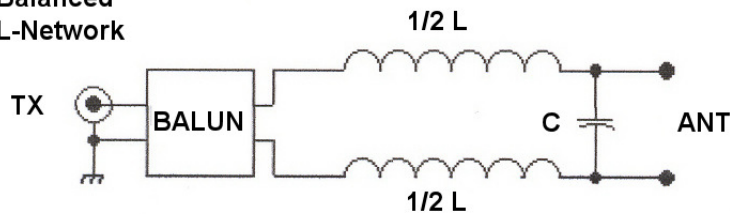

A single-ended L-network — the most common variety — uses a certain value of inductance ( $L$ ) and a certain value of capacitance ( $C$ ) to effect a match at a particular frequency for a particular antenna feedline impedance and length. For coaxial cable systems, the single-ended L-network provides the lowest loss of any network matching system. However, one limitation is that with the capacitor on the antenna side of the coil, the system is limited to antenna terminal impedances greater than about 50 Ohms. If we wish to use the single-ended network with a balanced feedline, we have to add a balun on the output side of the network. Baluns work best with very low values of reactance on their output terminals, a condition that is difficult to obtain with most antennas that use parallel feedlines.

The balanced version of the L-network overcomes this limitation by providing a true balanced output directly from the network. For a particular antenna, operating frequency, and transmission line impedance and length, the matching circuit requires the same total circuit inductance and the same output capacitance as the single-ended network. However, the balanced circuit divides the inductance into

1-800-773-7931 WWW.PALSTAR.COM

## Rear Panel Description

7

#### BALANCED OUTPUT

Two Nylon high voltage connectors for output to RF balanced transmission lines. Balanced line of any impedance (300 $\Omega$ , 450 $\Omega$ , 600 $\Omega$ ) can be used to feed the antenna.

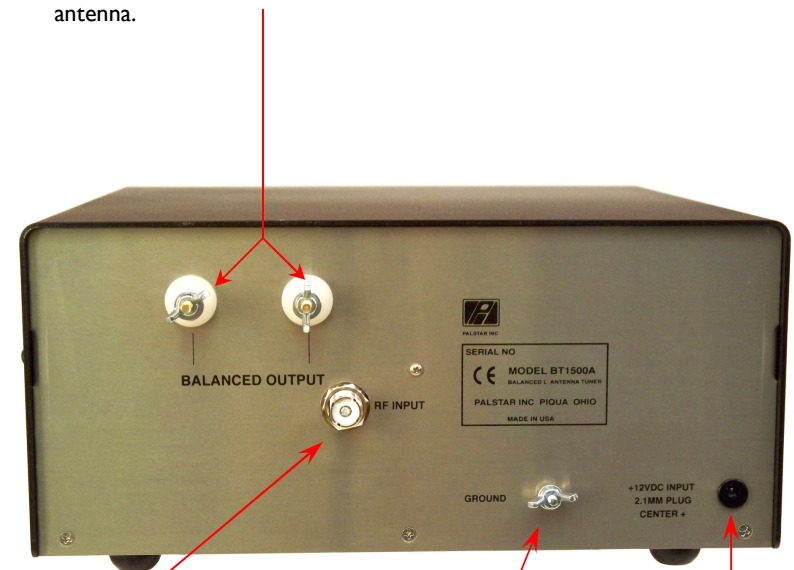

RF INPUT Coaxial connector for input from transmitter or amplifier.

GROUND Post/wing nut ground connector.

+12VDC INPUT (2.1 mm plug) for 12VDC.

FIGURE 1 REAR PANEL CONNECTORS

1-800-773-7931 WWW.PALSTAR.COM

## 8 Front Panel Description

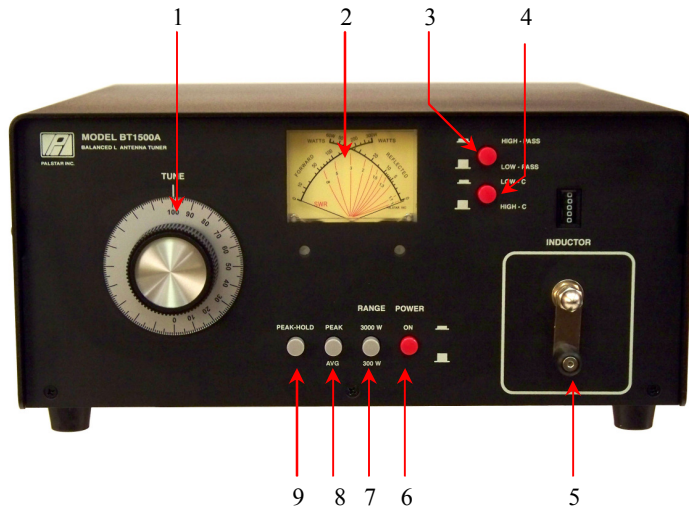

**1. TUNE.** Dual section variable capacitor (960 & 65pf). Can be switched from output to input side of network using switch # 4.

**2. POWER/SWR METER.** Dual needle meter displays FORWARD and REFLECTED power in watts. SWR is measured where the two needles intersect on the red scale. **Metering works only if the unit is provided with 12VDC at the rear power jack.**

**3. Hi-Lo PASS.** Two position switch selects Low Pass (High Z, capacitor on output side), and High Pass (Low Z, capacitor on input side). The switching is performed with a 40 amp contact relay. **This function only works if the unit is provided with 12VDC at the rear power jack.**

**4. Hi-Lo CAPACITOR.** Two position switch selects the low value variable capacitor section of 65pf, or parallels the two sections for a total of 1025pf. The switching is performed with a 40 amp contact relay. **This**

1-800-773-7931 WWW.PALSTAR.COM

## Operating Your BT1500A 13

reading of 50-100 watts on the FORWARD scale. Adjust the TUNE and INDUCTOR controls for a minimum REFLECTED reading while maintaining a FORWARD reading of 50-100 watts using your transmitter power control.

*The TUNE control varies the capacitor and provide fine adjustments. The INDUCTOR crank control provides coarse adjustment.*

7. Read the SWR on the red scale at the point where the two needles intersect. Repeat STEP 6 until the lowest SWR reading is obtained. The SWR should be 2:1 or lower.

8. When you have tuned your antenna to the best SWR, record the settings of the TUNE and INDUCTANCE controls on the chart above for future reference. When you retune, use these settings as your starting point.

**CAUTION: When approaching the end stops of the roller inductors, SLOW DOWN. Running the rollers too hard into the mechanical end stops on either end of the inductors can damage them.**

### Notes:

1. An SWR of 1:1 is best, but an SWR as high as 2:1 may be acceptable. Check your transmitter/amplifier manual for details.
2. If you cannot get an acceptable SWR, lengthen or shorten your antenna and/or feedlines and retune.
3. Any time a new or different antenna is connected, it is necessary to repeat the tuning procedure for each antenna.
4. Once every 4-6 months clean the roller coil with 70% isopropyl alcohol and a clean cotton cloth. Do not transfer any of the conducting grease on the rod that guides the roller wheel as this will contaminate the windings on the roller coil body. All points of rotation are factory lubricated and this is not required by the user. All moving parts are factory lubricated with Lithium grease only.

1-800-773-7931 WWW.PALSTAR.COM



## 12 Operating Your BT1500A

### Before Operating

1. To avoid possible damage to the BT1500A, set TUNE, INDUCTOR, and POWER RANGE switches as outlined in the chart below before applying transmitter power. (NOTE: the BT1500A must be supplied with 12VDC for the switch functions and the Peak/Peak Hold metering to work.)

2. Begin tuning with your transmitter/amp that is feeding the tuner set at a low output power setting (100 Watts).



**WARNING: DO NOT OPERATE THE BT1500A WITH THE COVER OFF.**

### Tuning

1. Select the band and frequency of desired operation.

2. Set TUNE and INDUCTOR controls to the suggested setting before applying transmitter power (see chart - documented with 270Ω non-reactive). Actual settings will vary from antenna to antenna.

3. Set your transmitter/amplifier to a low power output. If your transmitter has a TUNE position, select that position.

4. If you use a linear amplifier, set it to Standby. Do not use the linear amplifier until the BT1500A is tuned. **Do not exceed 1000 watts continuous (single tone) during operation.**

5. Set RANGE switch to 300W (button out).

6. Key your transmitter and adjust the power level for a

BAND	TUNING		SWITCH SETTING		INDUCTOR	
	SUGGESTED	ACTUAL	HI-C LO-C	HI-Z LO-Z	SUGGESTED	ACTUAL
160 M	66		HI-C	HI-Z	156	
80 M	35		HI-C	HI-Z	184	
40 M	20		HI-C	HI-Z	215	
20 M	11		HI-C	HI-Z	231	
17 M						
15 M	35		HI-C	HI-Z	237	
12 M	18		HI-C	HI-Z	238	
10 M	15		HI-C	HI-Z	240	

1-800-773-7931 WWW.PALSTAR.COM

## Front Panel Description 9

function only works if the unit is provided with 12VDC at the rear power jack.

5. **INDUCTOR.** Two 22uH roller inductors mounted in tandem, with turns counter.

6. **POWER.** A two position button. When in the IN position, turns on meter illumination and powers the Hi-Lo Pass and Hi-Lo Capacitor switch functions and the metering functions. The unit must be provided with 12VDC at the rear power jack.

7. **RANGE.** Two-position switch selects the range of FORWARD and REFLECTED power displayed on the power meter.

When the RANGE button is OUT, the FORWARD meter scale reads 300 watts full scale and the REFLECTED meter scale reads 60 watts full scale.

When the RANGE button is IN, the FORWARD meter scale reads 3000 watts full scale and the REFLECTED meter reads 600 watts full scale.

8. **PEAK/AVERAGE.** Selects between Average power reading and Peak power reading. Active circuitry provides a peak reading for SSB. For the Peak reading function to work, the POWER switch (#6) must be on.

9. **PEAK HOLD.** When the Peak reading function is selected (#8), the Peak Hold provides an approximate 2 second hold at the peak level for easy viewing. NOTE: The Peak Hold will function only if the PEAK button (#8) and the Power button (#6) are depressed as well.

1-800-773-7931 WWW.PALSTAR.COM

Schematic Diagram

**MODEL BT1500A**

1500 watt Dual Roller  
Balanced Tuner

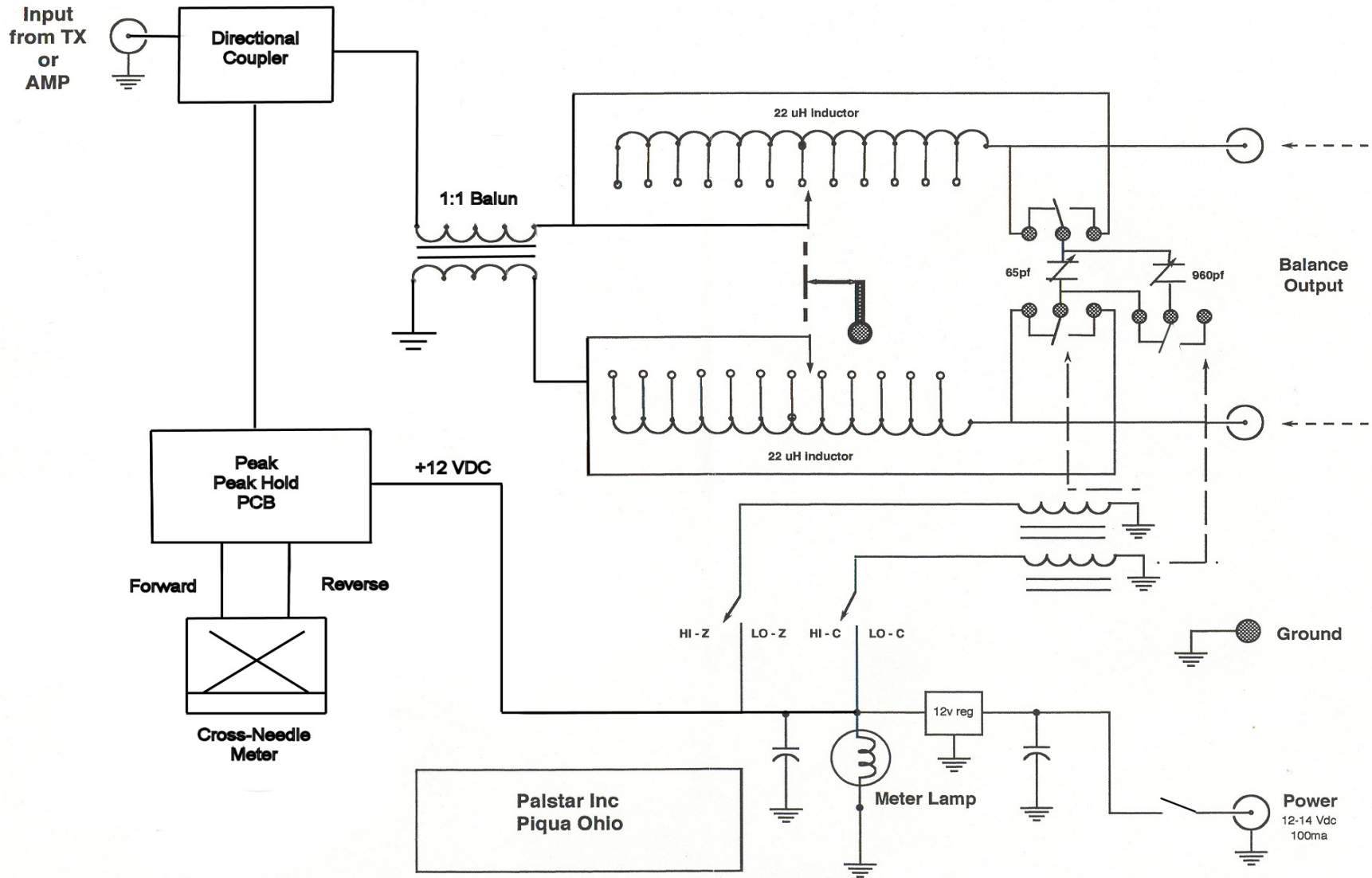

Palstar Inc  
Piqua Ohio