

MOTOR DRIVE MOUNT

K9000

TM Trunk Lid/Hatchback Mount
LRM Luggage Rack Mount

OPERATING INSTRUCTIONS

The OPERATING INSTRUCTIONS give you information on handling mount bracket and accessories. Before use, please read carefully.
SAVE THESE INSTRUCTIONS.

The K9000 mount is designed for lightweight VHF/UHF mobile antennas that do not require direct RF grounding. Flexible antennas (NR770H series) are desirable as they reduce vibration and shock transferred to the K9000. Excessive torque should be minimized to ensure satisfactory performance of the K9000.

Recommended Antennas

For best performance, we recommend DIAMOND NR & SG series antennas under 45" (such as NR73BNMO, NR770HA, NR770HB, NR770RA, NR770HNMO, NR770HBNMO, SG7500NMO, and SG7500A and SG-M510). Use the DIAMOND SO-239 UHF style base connector and cable assemblies (DIAMOND C101, C211, C213). For NMO style antennas, use the DIAMOND C101NMO.



Important Safety Instructions

- Vibration during driving may cause loosening of bolts and screws. Check periodically and fasten if necessary. "Loctite" compound can be used to secure threads.
- Should the antenna and mount bracket receive a sharp impact, they could be broken and fall off which could cause personal injury or damage. Drive carefully and avoid hazardous branches of trees, etc.
- Strong vibration (i.e. vehicles with diesel engines) may cause excessive stress on the K9000 mount. Install the antenna far away from the source of vibration.



Caution

To prevent any damage of the mount bracket, pay attention to the following instructions.

- This mount bracket is designed for 12 volt negative ground vehicles. Do not use it in a vehicle with incorrect voltage.
 - Do not operate the mount bracket if external temperature is near freezing or below.
 - Avoid hitting obstacles during driving. To prevent such a situation, the mount bracket has a back torque limiter which has a spring to absorb impact. This back torque limiter will work in one direction only.
- * The mount bracket is designed for use in negative ground cars. When the mount bracket is used in positive grounded cars, the lamp will not light. Reverse connection of the power cord.

Explanation of Operation

The antenna may be raised or lowered by depressing Control Switch. The mount motor contains a limit switch which shall stop the antenna automatically at its end of travel. When the switch is ON, the green lamp is lit when raising the antenna and the red lamp is lit when lowering the antenna.

Features

- The mount bracket has a spring-type back torque limiter which can prevent the antenna from rattling and protect the car and mount bracket.
- A protective rubber sheet is attached to K9000TM bracket which reduces possible discolorations or scratching of painted surfaces.
- The mount bracket is fully adjustable from angles 45–90 degrees. You can choose from 7 levels of adjustment with the control knob (on side of motor drive).
- For simple wiring of motor drive, a cigar plug is included. Mounting bracket and base fitment assemblies are separate for easy angle adjustment.

Confirm the parts

Confirm all parts in the package. If any part of the mount bracket is broken or missing, contact RF Parts with the part number.

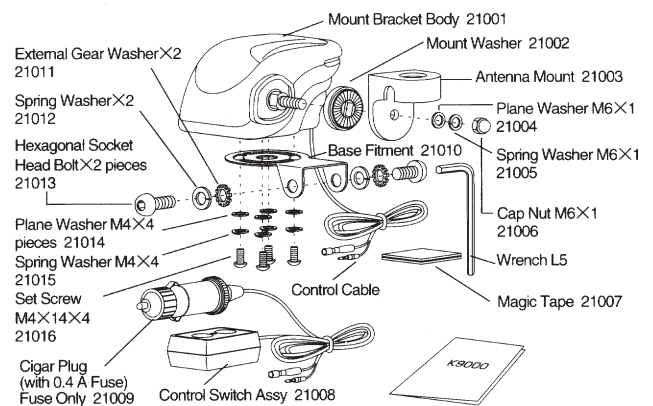

Options

To install the mount bracket, optional mount hardware and coaxial cables are needed. Choose the optional parts to match the installation location.

a. K9000TM for Trunk/Hatchback Installation Example

● Trunk Installation Example

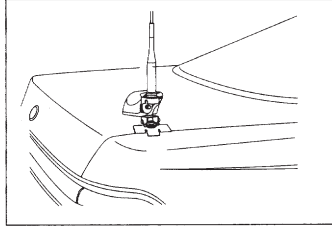
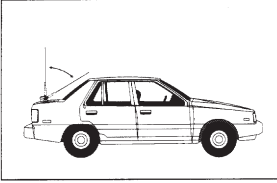

● Trunk Installation Example

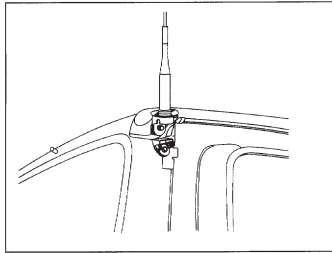
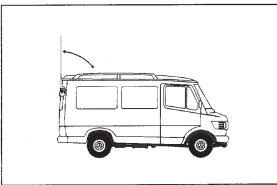

b. K9000LRM for Roof Rail/Carrier Pipe Installation Example

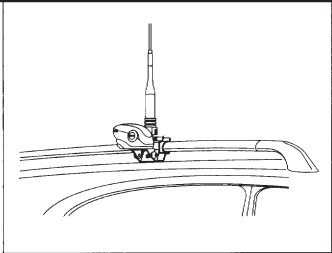
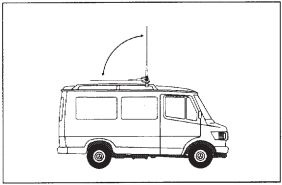

Mount Bracket Parts and Bracket Installation

Mount Bracket Parts for Trunk/Hatchback

● K9000TM Hardware kit

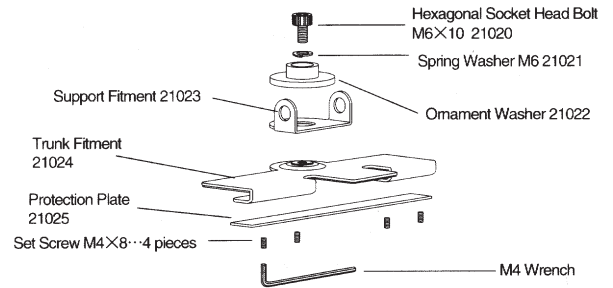

● Installing Motor Drive to Bracket

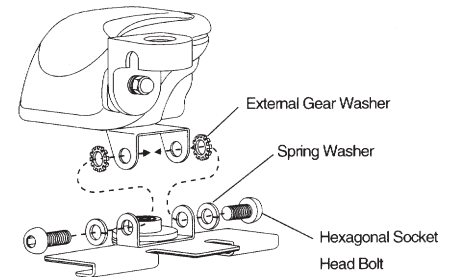

Mount Bracket Parts for Roof Rail/Carrier Pipe

● K9000LRM Hardware kit

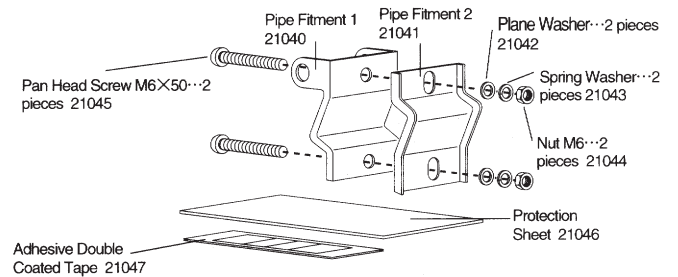

● Installing Motor Drive to Bracket

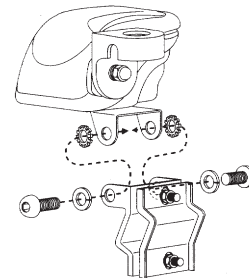

Explanation of Operation

Warning

* The back torque limiter contained on this mount bracket can work only when the limit switch is ON in response to raising an antenna. For this reason, backlash shall be avoided. The position of installation should not be reversed. Change the direction of the mount bracket body if you want to lower the antenna to the reverse direction.

1. Trunk/Hatchback (K9000TM Mount Bracket)

- Installing K9000TM Mount Bracket on Car
- Choose desired mounting location to ensure strength of mount, best performance of antenna, and proper opening and closing of trunk/hatchback.
- Slide mounting bracket over lip edge of trunk/hatchback. Fasten mounting set screws using enclosed metal protection plate between screws and vehicle. Install antenna. (See recommended antennas for proper antenna selection.)

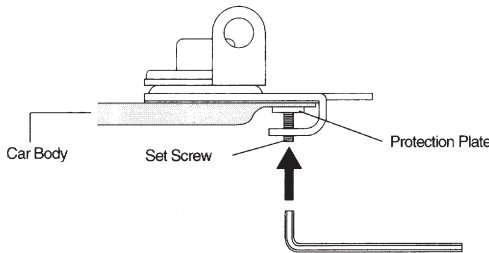

- Proper angle adjustment on trunk/hatchback installations:

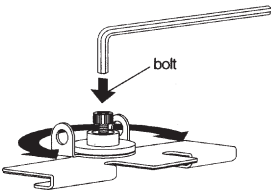

① Loosen mount bolt and turn mount laterally.

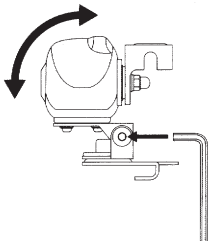

② Raise and adjust the mount bracket body horizontally.

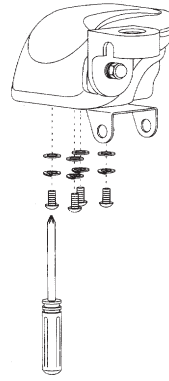

③ Loosen the set screws on bottom of mount bracket body. Turn the mount bracket laterally to adjust direction of antenna's "down" position. If you want to turn more than 50 degrees, detach the mount bracket and parts, and then adjust.

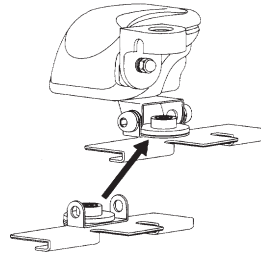

* If proper angle adjustment is not possible due to contact between the mount bracket and the car body, move installation to different location while maintaining proper raise/lower direction.

2. Roof Rail/Carrier Pipe (K9000LRM Mount Bracket)

- Installing K9000LRM Mount Bracket on Car

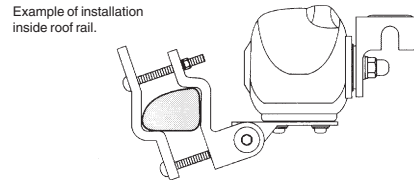
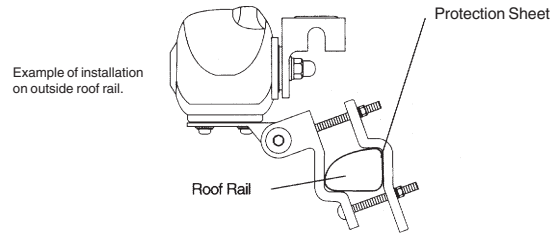

- K9000LRM mount bracket can be installed on round and square pipes or rails.

- Dimensions of pipes and roof rails

K9000LRM mount bracket can be installed on various pipes and roof rails by adjusting fits as shown. Install antenna. (See recommended antennas for proper antenna selection.)

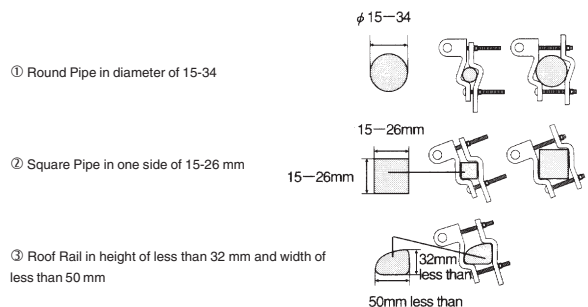

Power Cord Wiring

- Attach wires from control box and motor drive mount. A positive voltage is applied on both power cords. If power cords are forced unreasonably or pinched, the fuse may blow due to the short.
- Wire the connector of the control box to the connector of the mount bracket. Insert cigar plug.

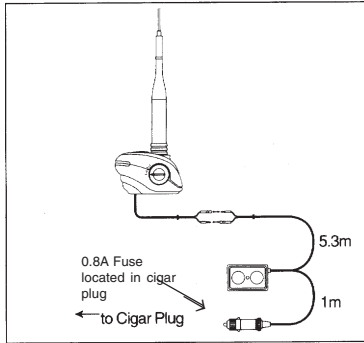

* Using fuse greater than 0.5 Amp may cause damage to mount.

Operating Angle Adjustment

- Mount the antenna before making angle adjustment. Turning of the adjust knob during antenna's down position may cause damage to the limit switch.
- * Operating angle at shipment is set at 45 degrees.

① Set antenna to be raised to 90 degrees by operating the control switch.

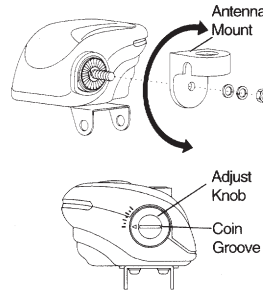

② Loosen the nut (side of antenna mount) and set antenna for vertical position.

③ Adjust knob by using coin in coin groove.

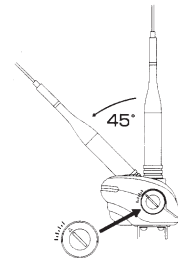
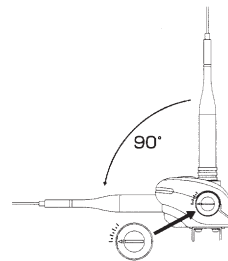

- Fasten screws after adjusted.

▲ This product was manufactured under strict quality control, if damage occurred during shipping, contact your dealer.

▲ Design and specifications of this product are subject to change without notice.

Specifications

Antenna Length to be Installed	45" maximum
Antenna Weight to be Installed	1 lb. maximum
Operating Voltage	13.8 V (10-16 V)
Operating Current	less than 0.4 A
Operating Time	about 4 seconds (0-90°)
Operating Angles	45-90 degrees
Fuse Capacity	0.8A