

ALINCO

VHF/UHF TWIN BAND FM RADIO

DR-735T/E

Instruction Manual

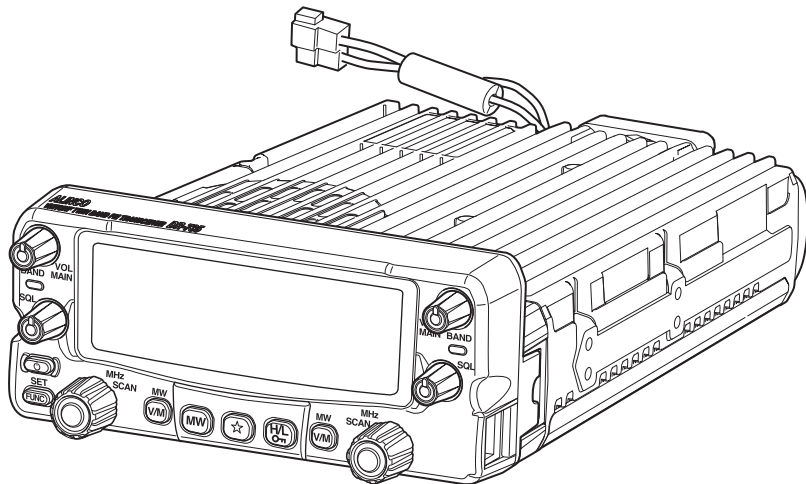

Thank you for purchasing your new Alinco radio.

This Instruction manual contains important safety and operating instructions. Please read this manual carefully before using the product and keep it for future reference.

**ALINCO**
INCORPORATED

NOTICE / Compliance Information Statement

This equipment has been tested and found to comply with the limits for a Class B digital device, pursuant to part 15 of the FCC Rules.

These limits are designed to provide reasonable protection against harmful interference in a residential installation. This equipment generates, uses, and can radiate radio frequency energy and, if not installed and used in accordance with the instruction manual, may cause harmful interference to radio communications. However, there is no guarantee that interference will not occur in a particular installation. If this equipment does cause harmful interference to radio or television reception, which can be determined by turning the equipment off and on, the user is encouraged to try to correct the interference by one or more of the following measures:

- *Reorient or relocate the receiving antenna.*
- *Increase the separation between the equipment and receiver.*
- *Connect the equipment into an outlet on a circuit different from that to which the receiver is connected.*
- *Consult the dealer or an experienced radio/TV technician for help.*



Tested to Comply
With FCC Standards
FOR HOME OR OFFICE USE

Information in this document is subject to change without notice or obligation. All brand names and trademarks are the property of their respective owners. Alinco cannot be liable for pictorial or typographical inaccuracies. Some parts, options and/or accessories are unavailable in certain areas. Changes or modifications not expressly approved by the party responsible for compliance could void the user's authority to operate the equipment.

VHF/UHF FM Radio DR-735T

This device complies with Part 15 of the FCC Rules. Operation is subject to the two conditions: (1) This device may not cause harmful interference, and (2) this device must accept any interference received, including interference that may cause undesired operation.

Manufacturer: ALINCO, INC

Yodoyabashi-Dai building 13th Floor 4Chome 4-9, Koraibashi, Chuo-ku, Osaka 541-0043, JAPAN

An amateur radio license is required to operate this device.



Conformity Information

In case the unit you have purchased is marked with a CE symbol, a copy of relative conformity certificate or document can be reviewed at <http://www.alinco.com/usa.html>.

Information and specifications are subject to change without notice.

We will replace the manual if manufacturing/printing may be defective, but can't be responsible of eventual typographical errors and misinterpretations.

Alinco and ALINCO logo are registered trademarks of Alinco Incorporated in Japan, the United States, EU States, Russia, China and many other countries.



Windows is a registered trademark of Microsoft Corporation in the United States and other countries.



All other trademarks are the properties of their respective holders.

Copyright © 2016 All right reserved. No part of this document may be reproduced, copied, translated or transcribed in any form or by any means without the prior written permission of Alinco, Inc., Osaka, Japan. English Edition
Printed in Philippines.

WARNING











To prevent any hazard during operation of Alinco's radio product, in this manual and on the product you may find symbols shown below. Please read and understand the meanings of these symbols before starting to use the product.

| | |
|--|---|
|  Danger | This symbol is intended to alert the user to an immediate danger that may cause loss of life and property if the user disregards the warning. |
|  Alert | This symbol is intended to alert the user to a possible hazard that may cause loss of life and property if the user disregards the warning. |
|  Caution | This symbol is intended to alert the user a possible hazard that may cause loss of property or injure the user if the warning is disregarded. |

| | |
|---|--|
|  | Alert symbol. An explanation is given. |
|  | Warning symbol. An explanation is given. |
|  | Instruction symbol. An explanation is given. |

ALERT

■ Environment and condition of use:

-  Do not drive while handling the radio for your safety. It is recommended that you check local traffic regulations regarding the use of radio equipment while driving. Some countries prohibit the operation of radio while driving.
-  Do not use this product in close proximity to other electronics devices, especially medical ones. It may cause interference to those devices.
-  Keep the radio out of the reach of children.
-  In case a liquid leaks from the product, do not touch it. It may damage your skin. Rinse with plenty of cold water if the liquid contacted your skin.
-  Never operate this product in facilities where radio products are prohibited for use such as aboard aircraft, in airports, in ports, within or near the operating area of business wireless stations or their relay stations.
-  Use of this product may be prohibited or illegal outside of your country. Be informed in advance when you travel.
-  The manufacturer declines any responsibilities against loss of life and/or property due to a failure of this product when used to perform important tasks like life-guarding, surveillance, and rescue.
-  Do not use multiple radios in very close proximity. It may cause interference and/or damage to the product(s).
-  Never install this product in a place that may obstacle proper functions of car safety devices such as seat belts and air bags.
-  The manufacturer declines any responsibilities against loss of life and property due to a failure of this product when used with or as a part of a device made by third parties.
-  Use of third party accessory may result in damage to this product. It will void our warranty for repair.

■ **Handling this product:**

- ⚠ Be sure to reduce the audio output level to minimum before using an earphone or a headset. Excessive audio may damage hearing.
- ⊘ Do not open the unit without permission or instruction from the manufacturer.
- ⊘ Unauthorized modification or repair may result in electric shock, fire and/or malfunction.
- ⊘ Do not operate this product in a wet place such as shower room. It may result in electric shock, fire and/or malfunction.
- ⊘ Do not place conductive materials, such as water or metal in close proximity to the product. A short-circuit to the product may result in electric shock, fire and/or malfunction.
- ⊘ Do not touch the heatsink (on/around the unit mostly found on mobile-base units) as it may become very hot during/after the operation that may risk burn your skin.

■ **About power-supply:**

- ⚠ Use only appropriate, reliable and certified power supply of correct voltage and capacity.
- ⊘ Do not connect cables in reverse polarity. It may result in electric shock, fire and/or malfunction.
- ⊘ Do not plug multiple devices including the power-supply into a single wall outlet. It may result in overheating and/or fire.
- ⊘ Do not handle a power-supply with a wet hand. It may result in electric shock.
- ⚠ Securely plug the power-supply to the wall outlet. Insecure installation may result in short-circuit, electronic shock and/or fire.
- ⊘ Do not plug the power-supply into the wall outlet if the contacts are dirty and/or dusty. Shortcircuiting and/or overheating may result in fire, electric shock and/or damage to the product.
- ⊘ Do not modify or remove fuse-assembly from the DC-cable. It may result in fire, electric shock and/or damage to the product.

■ **In case of emergency:**

In case of the following situation(s), please turn off the product, switch off the source of power, then remove or unplug the power-cord. Please contact your local dealer of this product for service and assistance. Do not use the product until the trouble is resolved. Do not try to troubleshoot the problem by yourself.

- When a strange sound, smoke and or strange odor comes out of the product.
- When the product is dropped or the case is broken or cracked.
- When a liquid penetrated inside.
- When a power-cord (including DC-cables, AC-cables and adapters) is damaged.





- ⚠ For your safety, turn off then remove all related AC-lines to the product and its accessories including the antenna if a thunderstorm is likely.
- ⚠ Turn off the unit, remove the mobile antenna from its base and keep it in the vehicle if a thunderstorm is likely.
Please read cautions regarding the lightning-protection on page 4 also.

■ Maintenance





-  Do not open the unit and its accessories. Please consult with your local dealer of this product for service and assistance.

CAUTION





■ Environment and condition of use:

-  Do not use the product in proximity to a audio products such as TV, radio and stereo. It may cause interference or receive interference.
-  Do not install in a humid, dusty or insufficiently ventilated place. It may result in electric shock, fire and/or malfunction.
-  Do not install in an unstable or vibrating position. It may result in electric shock, fire and/or malfunction when/if the product falls to the ground.
-  Do not install the product in proximity to a source of heat and humidity such as a heater or a stove. Avoid placing the unit in direct sunlight.
-  Do not modify, dismantle, incinerate, or immerse the batteries that may be used in accessories you use with this product.
Please check your local regulations for details on recycling option or disposal of the batteries in your area.

■ About radio

-  Do not connect devices other than specified ones to the jacks and ports on the product. It may result in damage to the devices.
-  Turn off and remove the power-source (AC cable, DC cable, battery, cigar-cable, charger adapter etc) from the product when the product is not in use for extended period of time or in case of maintenance.
-  Never pull the cord alone when you unplug AC cable from the wall outlet.
-  Use a clean, dry cloth to wipe off dirt and condensation from the surface of the product. Never use thinner or benzene for cleaning. Use cleaners recommended to audio-video devices in case very dirty.

■ About power-supply

-  Use only reliable power supply of specific DC output range and be mindful of the polarity of the cables and DC jack.
-  Always turn off the power supply when connecting or disconnecting the cables.
-  When using an external antenna, make sure that the antenna ground is not common with the ground of the power supply.
-  European users: When a radio is powered from an external DC power source (adapter, power supply, cigar-plug etc), make sure that this power supply has approval to the level of IEC/EN 60950-1.
-  Do not put magnetic cards like credit card, magnetic key etc. on/around the radio. It may risk deleting data from the cards.

Before Operating the Radio

Attention

- Do not remove the case or touch the interior components. Tampering can cause equipment trouble.
- Do not use or keep the radio where it is exposed to direct sunlight, dusty places, or near sources of heat.
- When transmitting for long periods of time at high power, the radio might overheat. This product is NOT a 100%-duty transmitter.
- Turn the power off immediately if the radio emits smoke or strange odors. Ensure the radio is safe, then bring it to the nearest Alinco service center.
- An operator's license is required for this device.

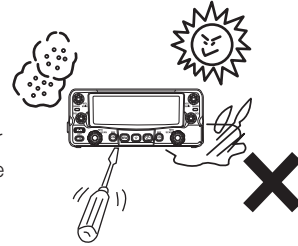

About hazardous materials used in this product.

The product that comes with this manual is free from dangerous material such as lead and cadmium as per RoHS order of EU.

The radio has no protection against lightning.

The user is responsible for providing adequate protection if he/she uses the device at home and installs the antenna outdoor. Be aware that any outdoor antenna creates a direct path for lightning current (more than 10kA) to the radio. This path exists whether the device is turned ON or OFF.

Any vehicle does not present a safe environment during lightning. This environment becomes much more dangerous if an outdoor antenna is installed on the car. Move the antenna and its cable into the car at the first sight of forthcoming thunderstorm and lightning.

Contents

WARNING

| | |
|--|-----------|
| Before Operating the Radio | 4 |
| Introduction | 8 |
| ★key | 8 |
| New and Innovative Features | 8 |
| Standard Accessories | 9 |
| Initial Installation | 10 |
| Microphone connection | 10 |
| Antenna Connection | 10 |
| For a base station set up..... | 10 |
| For mobile station set up..... | 11 |
| Location | 11 |
| Front Panel | 12 |
| Installing a Mobile Antenna | 13 |
| Using the mounting bracket | 13 |
| Controls, Connectors, and Display | 14 |
| Control Keys Operation | 14 |
| Front Panel | 14 |
| Rear Panel..... | 16 |
| Antenna Connection | 16 |
| External Speaker Connection | 16 |
| Display | 17 |
| Microphone EMS-78 (Please refer to P.73 for EMS-79) | 18 |
| Basic Operations | 19 |
| Turning the unit on and off | 19 |
| Switching the MAIN band | 19 |
| Switching operation band | 19 |
| Audio level setting | 19 |
| Squelch level setting | 20 |
| VFO mode | 20 |
| Changing frequency by channel step | 20 |
| Tuning step selection | 21 |
| Shift Direction and Offset frequency setting | 22 |
| Memory Mode | 23 |
| Programming memory channel (s) | 23 |
| Easy memory programming mode | 24 |
| Programmable data in the memory channel | 24 |
| Recalling a memory channel | 24 |
| Overwriting memory channels | 25 |
| Erasing Memory channels..... | 25 |
| Copying memory data to VFO (Except dual-memory channels) ... | 26 |
| Dual Memory Function | 26 |
| Programming dual memory channel | 26 |
| Recalling dual memory channel | 27 |

| | |
|--|-----------|
| Overwriting dual memory channel | 27 |
| Erasing dual memory channel | 27 |
| Channel name (Alphanumeric) registration function | 28 |
| Memory Bank Function | 29 |
| CALL Channel | 30 |
| Recalling CALL Channel | 30 |
| Editing CALL channel data | 30 |
| To receive signals..... | 31 |
| Monitor Function..... | 31 |
| Reverse Function | 32 |
| To Transmit | 32 |
| Selecting Output Power..... | 33 |
| Set mode | 34 |
| A list of setting mode Menus and parameters..... | 34 |
| To operate the Set mode..... | 35 |
| Set mode menu | 36 |
| Menu 01. Channel Step setting | 36 |
| Menu 02. Modulation mode | 36 |
| Menu 03. Microphone gain adjustment | 36 |
| Menu 04. Scan type selection | 37 |
| Menu 05. Memory scan mode selection..... | 37 |
| Menu 06. Beep sound level selection | 38 |
| Menu 07. VFO beep ON/OFF | 39 |
| Menu 08. Pager ON/OFF (BELL feature) | 39 |
| Menu 09. Color mode selection | 40 |
| Menu 10. Display color selection for Stand-by | 41 |
| Menu 11. Display color selection for Receiving..... | 41 |
| Menu 12. Display color selection for transmitting | 42 |
| Menu 13. Dimmer Level setting | 42 |
| Menu 14. Display illumination timer..... | 43 |
| Menu 15. Contrast setting..... | 43 |
| Menu 16. Attenuator setting | 44 |
| Menu 17. Memory protection | 44 |
| Menu 18. Sub PTT assignment (Only EMS-78) | 45 |
| Menu 19. Key-holding time setting | 46 |
| Menu 20. Auto repeater shift..... | 46 |
| Menu 21. Restore function | 47 |
| Advanced set mode | 48 |
| A list of the advanced set mode menus and parameters | 48 |
| To use the advanced set mode | 48 |
| Menu 22. Auto Power OFF (APO) | 49 |
| Menu 23. Time out timer (TOT) | 49 |
| Menu 24. TOT Penalty | 50 |
| Menu 25. Tone burst tones | 50 |
| Menu 26. Busy channel lock out (BCLO) | 51 |
| Menu 27. Sub band mute during transmission | 52 |
| Menu 28. Scan illumination | 52 |
| Menu 29. Cooling fan setting | 53 |

| | |
|--|-----------|
| Menu 30. Mid output power | 54 |
| Menu 31. Image signal rejection | 54 |
| Menu 32. TNC mode | 55 |
| Menu 33. Memory channel mode selection | 56 |
| Menu 34. SUB band mute..... | 56 |
| Useful functions | 57 |
| Single-band mode | 57 |
| VFO Auto-program function | 57 |
| Scan Function | 58 |
| VFO Scan | 58 |
| Memory Scan | 59 |
| Dual Memory Scan..... | 59 |
| Skip and favorite channels setting | 59 |
| Programmed Scan | 60 |
| Priority Scan | 61 |
| Tone Scan | 61 |
| DCS Scan | 62 |
| Key-Lock | 62 |
| Short-Cut key | 63 |
| RGB color setting..... | 63 |
| Selective Communication | 65 |
| CTCSS encoding, Tone-squelch and DCS operations..... | 65 |
| Auto-dialer | 67 |
| To Program the Auto-dialer: | 67 |
| Transmitting the stored Auto-dialer codes | 67 |
| Digital voice communication | 68 |
| Cable clone function | 69 |
| XBR (Crossband Repeater) Mode / T-models only | 71 |
| XBR Mode operation | 71 |
| Packet Communication | 72 |
| Remote Control Operation (EMS-79 Only) | 73 |
| Mic. Connector Diagram | |
| (While looking in the front view of the connector) | 74 |
| Maintenance / Reference | 75 |
| Reset | 75 |
| Basic Reset | 75 |
| VFO Reset | 75 |
| Memory Reset..... | 75 |
| RGB Reset | 75 |
| All Reset | 75 |
| Troubleshooting | 76 |
| Optional accessories | 77 |
| EDS-30 (Optional) Installation | 77 |
| Specification | 78 |
| Details of frequency / steps in AUTO mode | 79 |

Introduction

Thank you very much for purchasing this excellent Alinco radio. Our products are ranked among the finest in the world. This radio has been manufactured with state of the art technology and it has been tested carefully at our factory. It is designed to operate to your satisfaction for many years under normal use.

PLEASE READ THIS MANUAL COMPLETELY TO LEARN ALL THE FUNCTIONS THE PRODUCT OFFERS. WE MADE EVERY ATTEMPT TO WRITE THIS MANUAL TO BE AS COMPREHENSIVE AND EASY TO UNDERSTAND AS POSSIBLE. IT IS IMPORTANT TO NOTE THAT SOME OF THE OPERATIONS MAY BE EXPLAINED IN RELATION TO INFORMATION IN PREVIOUS CHAPTERS. BY READING JUST ONE PART OF THE MANUAL, YOU RISK NOT UNDERSTANDING THE COMPLETE EXPLANATION OF THE FUNCTION.

★key

This is an programmable key. Desired functions or operation can be assigned to ★ key (P.63). There is not a factory default allocation for this key, therefore only beep will be heard by pressing this key unless this key is programmed.

New and Innovative Features

Your new radio features some of the most advanced functions and reliable engineering available anywhere. The ALINCO design philosophy is focused on developing innovative, versatile features, including the following:

- The DR-735T/E is a true dual band transceiver. Full-duplex system provides VHF/UHF simultaneous operation, as well as VHF/VHF, UHF/UHF semi-duplex operations including VHF Air-Band reception in AM mode.
- A newly designed provides a powerful 50W both in the 144 and the 430MHz bands, making this rig capable of long distance communication. Large heat dissipation chassis with efficient cooling structure provides long time of operation.
- 2-band full independence of the dial, squelch and audio level on the left and right band with easy to press key layout.
- A large and clear color-selectable display panel with front control unit separation capability.
- Eight the RGB LED possible to set the favorite colors, including white to be registered in the LCD backlight. Assignment of a different color for TX, RX and stand-by, as well as the MAIN and SUB bands separately are possible.
- Two PTT switches on the EMS-78 microphone with capability of programming Sub-PTT switch for desired function such as low power TX, monitor, etc.
- Two microphone connectors, one on the MAIN unit and another on the control panel for convenient connection.
- Function to support cable-clone for restoring setting or data and computer programming capability.
- Squelch attenuator function.
- Shortcut key for easy access to set mode menu.
- Two external speaker jacks to separate audio output on the left and right bands.

Standard Accessories

Carefully unpack to make sure the following items are found in the package in addition to this manual.

■ Radio

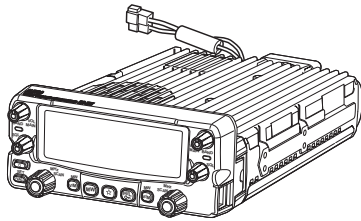

■ Microphone EMS-78 (with dual PTT) or EMS79 (with DTMF keypad)

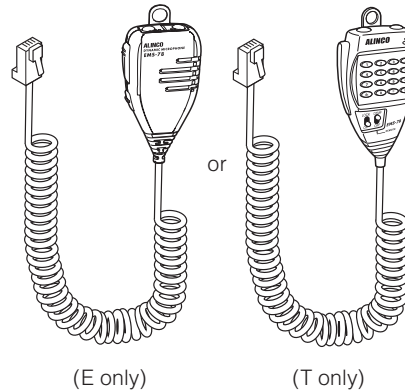

■ DC power cable including 15A fuse and holder

UA0038Y



■ Mobile Mounting bracket

FM0078Z

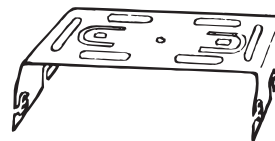

■ Hardware kit for bracket

Bracket screws
AE0012
(M4 x 8mm) x 4



Tapping screws
(M5 x 20mm) x 4



Screws
(M5 x 20mm) x 4



Hexagonal nut
(M5) x 5



The standard accessories may vary slightly depending on the version you have purchased.

Please contact your local authorized Alinco dealer should you have any questions.

Standard accessories may change without notice.

■ Warranty Policy

Please refer to any enclosed warranty information or contact your authorized Alinco dealer/distributor for the warranty policy before purchase.

Initial Installation

Microphone connection

Connect the microphone plug into microphone terminal on the right side of control panel or into other microphone terminal in front of MAIN unit. Insert the plug until hearing a click.

IMPORTANT When connecting, be mindful to the modular plug direction.

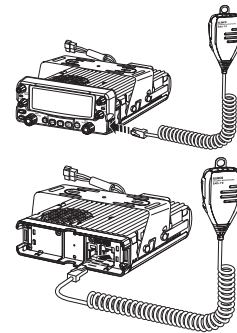

Antenna Connection

Connect 50Ω antenna that covers 2m/70cm bands, using good quality 50Ω coaxial cable.

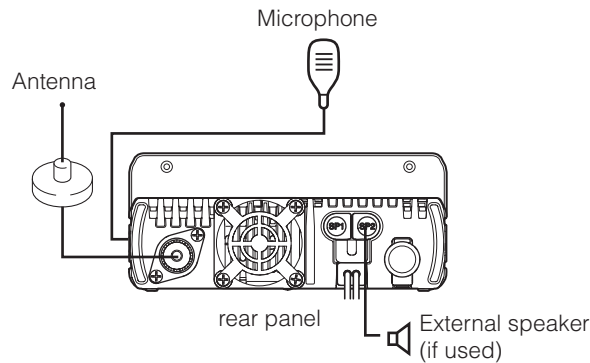

IMPORTANT Coupling the antenna to the radio via feed-lines having impedance other than 50Ω reduces the efficiency of the antenna system and can cause interference to nearby televisions, radio receivers and other electronic equipment.

For a base station set up

IMPORTANT

- Before connecting, be sure to turn off the radio and DC power supply.
- Be certain to use DC cable provided with unit.

The radio requires 13.8V DC negative grounded power supply. Use a regulated power supply capable of providing continuous current of 12A or more. Power supplies that do not meet specifications may cause malfunction and/or damage to the radio and will void the warranty. Alinco offers excellent communication-grade power supplies as optional accessories. Please contact your local authorized Alinco dealer.

IMPORTANT DC voltage range for operating this radio is DC 11.7V to 15.8V. Radio will not operate out of this range. Inspect cable and connection regularly to be sure there is not any damage or burning.

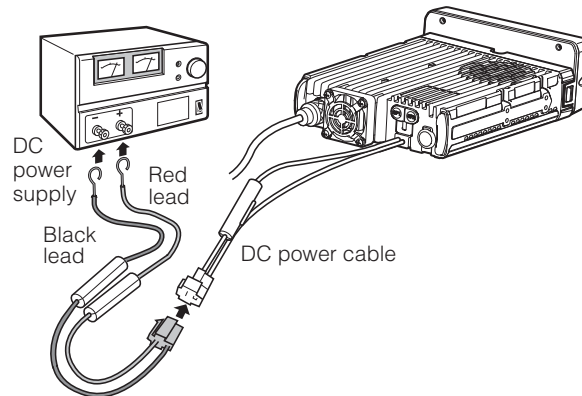

For mobile station set up

Location

The radio may be installed in any position in your vehicle, where the controls and microphones are easily accessible and it does not interfere with the safe operation of the vehicle or the performance of the radio. If your vehicle is equipped with air bags, be certain your radio will not interfere with their deployment. If you are uncertain about where to mount the unit, contact your vehicle's manufacture.

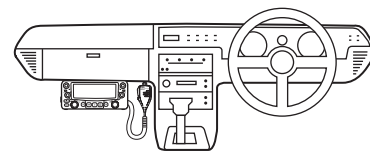

RF Hazard Warning

IMPORTANT The electro-magnetic (radio Frequency) exposure level of this device may exceed the European standards of the hazard level when transmitting at the high-power setting while connected to a unity gain antenna at a distance of 63cm or less from the operator. Furthermore, the hazardous RF exposure level depends on the conditions of the combination of the antenna gain, distance from the operator, output setting and installation environment, therefore the operator may be exposed to stronger RF even at a distance of more than 63cm. For safety purpose, it is recommended that the antenna be installed outside of, and as far as possible from, the operator's area. Avoid using an excessively high-gained antenna in case the distance between the operator and the antenna is very limited. Always use the minimum necessary output power for communications.

Front Panel

The main unit can be set with either side facing up. This can facilitate your ability to hear the speaker's audio clearly. Position the front panel as you prefer.

- ① Slide the front panel toward right while pulling the tab toward you.

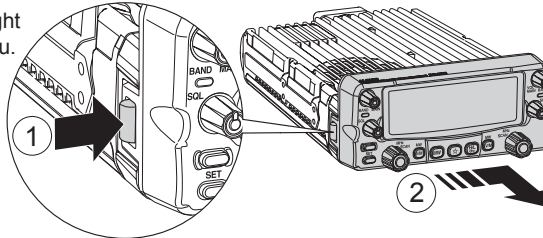

- ② Turn the front panel, being careful to keep the cable free from kinks.

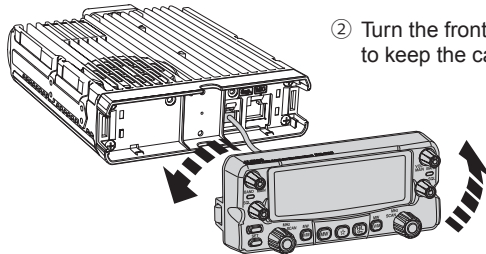

- ③ Match the catch in the main unit with the slot in the front panel and fit the front panel into the main unit.

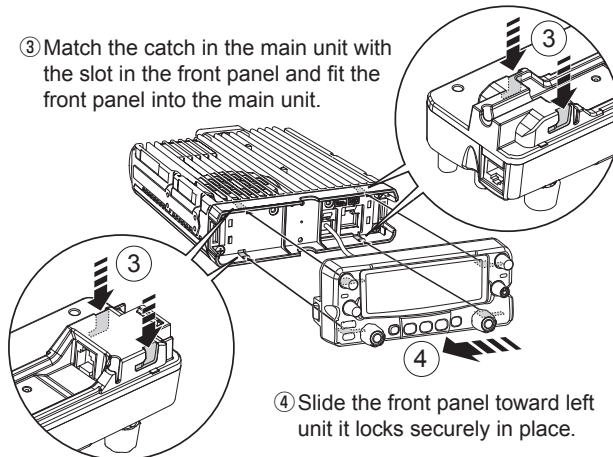

- ④ Slide the front panel toward left until it locks securely in place.



By using the optional separation kit EDS-30, you can install the front panel and the main unit in separate positions. The length of separation cable is 5m. See page 77 for details.

Installing a Mobile Antenna

Use a 50Ω coaxial cable to connect the antenna. Mobile antennas require an appropriate mounting base for proper installation and operation. For more information, see the instruction of your antenna.

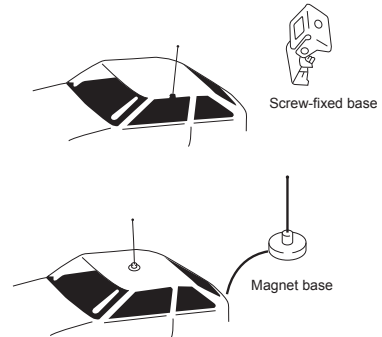

IMPORTANT After installing your antenna, ensure that you have the best possible SWR reading. High RF environments can cause severe damage to your unit. Ensure that you are not in a high RF environment when operating the radio.

Using the mounting bracket

1. **Drill 4 holes where the mounting bracket is to be installed.**

Approx. 5.5-6mm (1/4") when using nuts; approx. 2-3 mm (1/8") when using self-tapping screws.

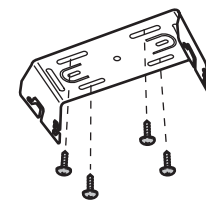

<For making 4+/-0.2mm hole in globe box bottom>

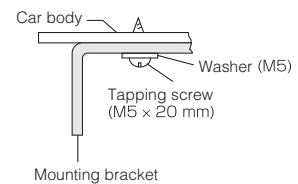

2. **Insert the supplied screws, nuts and washers through the mounting bracket and tighten.**
3. **Adjust the angle to suit your favorite position.**

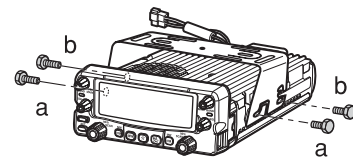

NOTE

Alinco's warranty does not include installation fee.

Controls, Connectors, and Display

Control Keys Operation

There are 3 types of key operations; simply press, press after pressing [FUNC] key while FUNC appears on the display, or press and hold.

- [Press] refers to press the key once and release the finger immediately.
- [FUNC + this Key] refers to press the FUNC key once, then press another key while FUNC icon appears on the display.
- [Press and hold] refers to press the key and hold it. The holding time is adjustable in set mode; factory default is 2 seconds.

Quickest way to save the change and return to operation is to press PTT key in most cases.

Front Panel

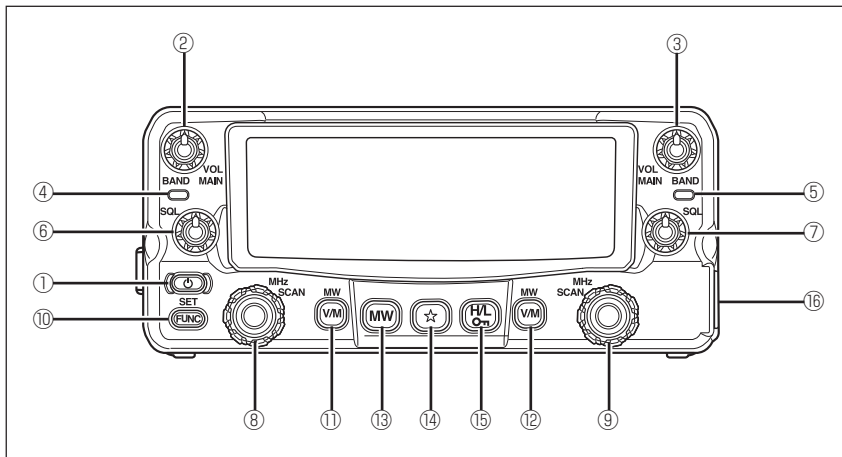

■ Primary Functions

| No. | Key | Function |
|-----|----------------------------|--|
| ① | Power Key | Turns the power on/off. (P.19) |
| ② | Left band [VOL] knob | Rotate to adjust audio sound level on the left band. (P.19) |
| ③ | Right band [VOL] knob | Rotate to adjust audio sound level on the right band. (P.19) |
| ④ | Left band TX/RX indicator | Indicates transmission (Red) or reception (Green) on the left band. |
| ⑤ | Right band TX/RX indicator | Indicates transmission (Red) or reception (Green) on the right band. |
| ⑥ | Left band [SQL] knob | Rotate to adjust squelch level on the left band. (P.20) |
| ⑦ | Right band [SQL] knob | Rotate to adjust squelch level on the right band. (P.20) |
| ⑧ | Left band dial | Rotate to select frequency, memory channel and various settings on the left band. |
| ⑨ | Right band dial | Rotate to select frequency, memory channel and various settings on the right band. |
| ⑩ | [FUNC] key | Sets functions. |
| ⑪ | Left band [V/M] key | Switches between VFO mode and memory mode on the left band. |
| ⑫ | Right band [V/M] key | Switches between VFO mode and memory mode on the right band. |
| ⑬ | [MW] key | Press to select dual Memory mode. |
| ⑭ | ★ key | Programmable function key.(P.63) |
| ⑮ | [H/L] key | Press to select Hi/Mid and Low output power. (P.33) |
| ⑯ | Microphone connector | For connecting microphone. |

■ Functions that requires press and holding to be activated

| No. | Key | Function |
|-----|-----------------------|--|
| ② | Left band [VOL] knob | Switches between VHF/Air-Band and UHF on the left band (P.19) |
| ③ | Right band [VOL] Knob | Switches between UHF/VHF and Air-Band on the right band (P.19) |
| ⑧ | Left band dial | Switches between VFO and memory scan on the left band. (P.58) |
| ⑨ | Right band dial | Switches between VFO and memory scan on the right band. (P.58) |
| ⑩ | [FUNC] key | Sets mode. (P.34) |
| ⑪ | Left-Band [V/M] key | Switches to Call channel on the Left-Band. (P.30) |
| ⑫ | Right-Band [V/M] key | Switches to Call channel on the Right-Band. (P.30) |
| ⑬ | [MW] key | Simple Memory writing. (P.24) |
| ⑮ | [H/L] key | Key lock. (P.62) |

* Hold timing is adjustable in set mode

■ Functions which can be activated while [FUNC] appears, after pressing [FUNC] key

| No. | Key | Function |
|-----|-----------------------|---|
| ② | Left band [VOL] knob | Switches to the single band mode on the left band. (P.57) |
| ③ | Right band [VOL] knob | Switches to the single band mode on the right band. (P.57) |
| ⑧ | Left band dial | Program scan on the left band. (P.59) |
| ⑨ | Right band dial | Program scan on the right band. (P.59) |
| ⑪ | Left band [V/M] key | Write frequency to selected memory on the left band. (P.23) |
| ⑫ | Right-Band [V/M] key | Write frequency to selected memory on the right band. (P.23) |
| ⑬ | [MW] key | Sets monitor function. (Reverse function when shift activated). (P.31) |
| ⑭ | ★ key | Selects Tone-squelch (CTCSS) or DCS. (P.65) |
| ⑮ | [H/L] key | Accesses the digital voice communication mode (required optional unit) (P.68) |

■ Functions which can be activated while pressing the [FUNC] key

| No. | Key | Function |
|-----|-----------------------|--|
| ① | ⏻ Power key | Normal Reset when turns the power on. (P.75) |
| ② | Left band [VOL] knob | Selects shift or offset frequency on the left band. (P.22) |
| ③ | Right band [VOL] knob | Selects shift or offset frequency on the right band. (P.22) |
| ⑧ | Left band dial | Sets priority scan on the left band. (P.61) |
| ⑨ | Right band dial | Sets priority scan on the right band. (P.61) |
| ⑪ | Left band [V/M] key | Erase the memory while memory mode is selected on the left band. (P.25) |
| ⑫ | Right band [V/M] key | Erase the memory while memory mode is selected on the right band. (P.25) |
| ⑬ | [MW] key | Sets auto-dialer memory. (P.67) |
| ⑭ | ★ key | Sets RGB backlight color. (P.63) |
| ⑮ | [H/L] key | Sets the channel name while Memory mode selected. (P.28) |

Rear Panel

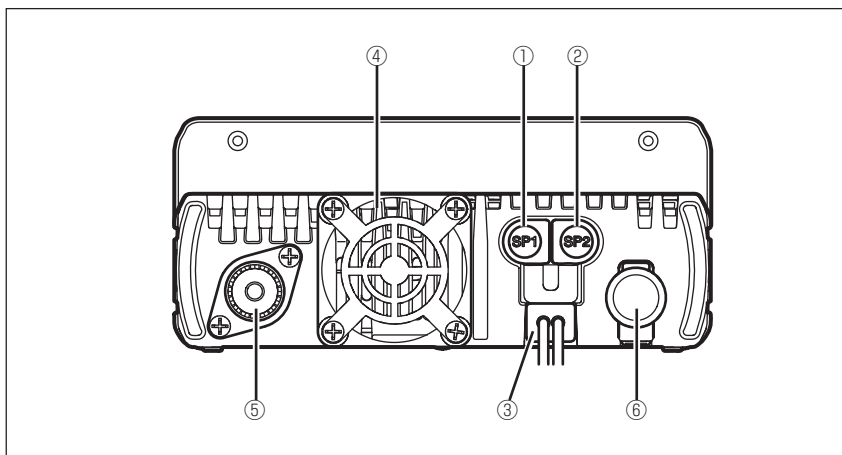

| No. | Key | Function |
|-----|-------------------------------|---|
| ① | External Speaker Jack 1 [SP1] | Connects an external 8Ω speaker. Outputs audio of the right band. When another speaker is not connected to [SP2], left band audio is heard through internal speaker. Also [SP1] used for connecting clone or PC cables. |
| ② | External Speaker Jack 2 [SP2] | Connects an external 8Ω speaker. Outputs audio of the left band. When another speaker is not connected to [SP1], right band audio is heard through internal speaker. |
| ③ | DC Power cable | Connects to the 13.8V DC power supply. |
| ④ | Air-cooling fan | Cools the unit during transmission or when the radio is hot. |
| ⑤ | Antenna connector | Connects to antenna with 50Ω impedance matched with operation frequency. |
| ⑥ | DIN connector (6 PIN) | Connects to external TNC unit for Packet communications. |

Antenna Connection

Before operating, install an efficient, well-tuned antenna. The success of your installation will depend on the type of antenna and its correct installation. Use a 50Ω impedance antenna and low-loss coaxial feed-line that has a characteristic impedance of 50Ω.



- Transmitting without first connecting an antenna or other matched load may damage the radio. Always connect the antenna to the radio before transmitting.
All fixed stations should be equipped with a lightning protection to reduce the risk of fire, electric shock, and damage to the radio.
- The antenna connector used is combined PL259/M. You may feel it too loose comparing to the specific ones, but it is not a defect. Please be sure to tighten the outer ring until it stops.

External Speaker Connection

- If you plan to use an external speaker, choose a speaker with an impedance of 8Ω. Each external speaker jacks accept a 3.5mm (1/8") mono (2-conductor) plug.
- External speaker adopt double port BTL, please care about the connection. Do not use the speaker that requires grounding.
- Carefully insert plug into jack. Do not twist the plug and do not apply stress on speaker jacks.
- When jacks are not in use, keep the [SP] cap (speaker jack cover) closed to keep contacts clean and avoid entering dust and other objects into the radio.
- Insert plugs into jacks completely until locks to prevent damaging the jack or plug.

Display

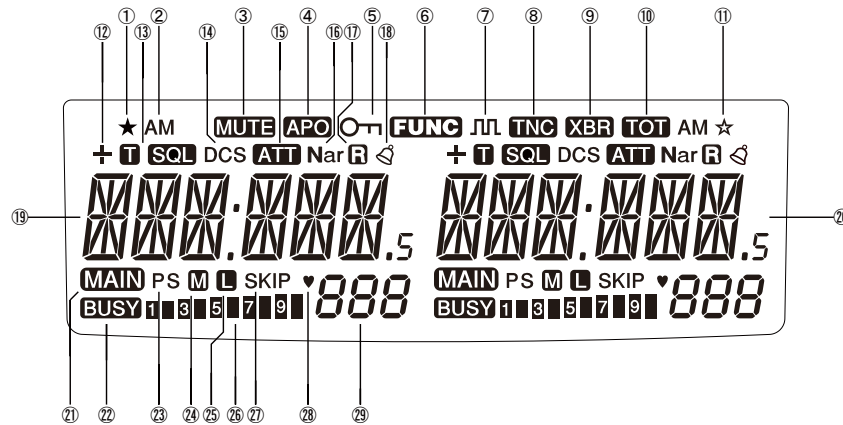

| No. | Key | Function |
|-----|-----------|---|
| ① | ★ | Appears when advanced set mode is available. (P.48) |
| ② | AM | Appears during AM reception. (P.36) |
| ③ | MUTE | Appears during transmission when other band is set for mute. (P.52) |
| ④ | APO | Appears when APO function is activated. (P.49) |
| ⑤ | 🔒 | Appears when setting the key lock. (P.62) |
| ⑥ | FUNC | Appears when [FUNC] key is pressed. (P.15) |
| ⑦ | 📻 | Appears when in the digital voice communication mode. (P.68) |
| ⑧ | TNC | Appears when in packet mode. (P.55) |
| ⑨ | XBR | Appears when cross-band repeater mode is available. (P.71) |
| ⑩ | TOT | Appears during time out timer setting. (P.49) |
| ⑪ | ★ | Appears during short cut setting. (P.63) |
| ⑫ | ⊕ - | Appears when setting the shift. (P.22) |
| ⑬ | T SQL | Appears when setting the tone squelch. (P.65) |
| ⑭ | DCS | Appears when setting the DCS. (P.66) |
| ⑮ | ATT | Appears when attenuator function is activated. (P.44) |
| ⑯ | Nar | Appears when in narrow band reception mode. (P.36) |
| ⑰ | R | Appears when reverse mode is activated. (P.32) |
| ⑱ | 🔔 | Appears when Bell function is activated. (P.39) |
| ⑲ | 📡.📡.📡.📡.5 | Indicates the VHF/UHF frequency or memory name on the left band side. (P.20, 28) |
| ⑳ | 📡.📡.📡.📡.5 | Indicates the VHF/UHF frequency or memory name on the right band side. (P.20, 28) |
| ㉑ | MAIN | Appears on the band with transmitting ability. (P.19) |
| ㉒ | BUSY | Appears when a signal is being received. (P.31) |
| ㉓ | PS | [S] Flashes during scan and [PS] flashes during program scan. (P.58) |
| ㉔ | M | Appears when transmission power is set to MID. (P.33) |
| ㉕ | L | Appears when transmission power is set to LOW. (P.33) |
| ㉖ | S meter | Indicates received or transmitted signal level. (P.31, 32) |
| ㉗ | SKIP | Appears during scan for skip channels. (P.59) |
| ㉘ | ♥ | Appears when a favorite channel is selected. (P.59) |
| ㉙ | 888 | Indicates memory numbers in the memory mode. (P.23) |

Microphone EMS-78 (Please refer to P.73 for EMS-79)

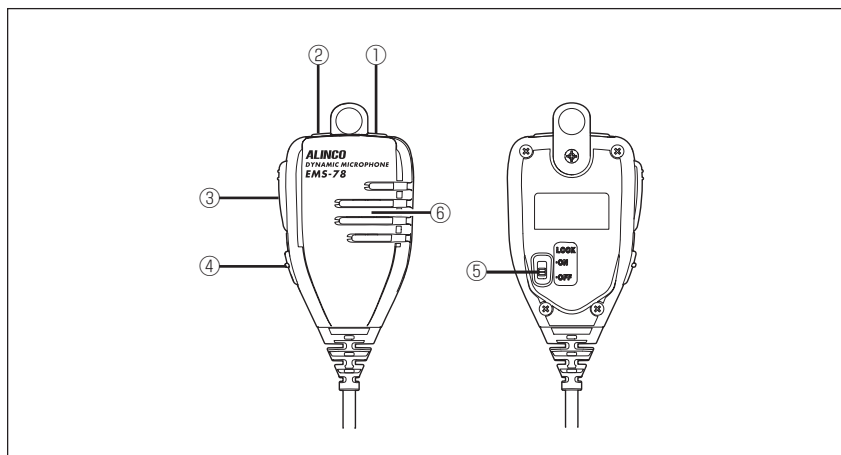

| No. | Key | Function |
|-----|-------------|--|
| ① | UP | Increase the frequency, memory channel number, or setting value. |
| ② | DOWN | Decrease the frequency, memory channel number, or setting value. |
| ③ | MAIN PTT | Press the PTT (Push-To-Talk) key to transmit. Also press this key to set the changes made by key operations. |
| ④ | SUB PTT | Press the PTT (Push-To-Talk) key to transmit on sub band. Also used for other functions assigned in set mode. (P.45) |
| ⑤ | LOCK SWITCH | Locks out the UP and DOWN keys. |
| ⑥ | MIC | Speak to here during transmission. |

Unless otherwise specified, PTT key refers to the MAIN PTT in this manual.

■ Microphone Connector pin Assignment (Front view)

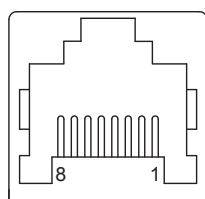

- 1.DC5V
- 2.DOWN
- 3.REMOTE
- 4.PTT
- 5.MIC GND
- 6.MIC
- 7.GND
- 8.UP

IMPORTANT

- Connect the microphone modular plug provided with the unit into microphone jack.
- Insert the plug until hearing a click. When connecting, be mindful to the modular plug direction.
- When removing microphone, press the lock on connector then pull the plug out. Do not pull the microphone's cable to remove the microphone from radio.
- When using optional EDS-8 (8 pin to modular converter), fix EDS-8 cable on the bracket to avoid stress on modular socket.
- Be careful not to confuse the separation cable port with the microphone port. Wrong connection may cause damage to the radio.

Basic Operations

Turning the unit on and off

Press and hold the PWR key until turns on.

Repeat it until turns off. To avoid accidentally turn on/off, PWR key operation is designed to press and hold the key for 2 seconds.

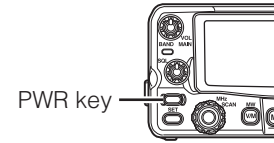

Switching the MAIN band

In this manual the MAIN band refers to the band which selected for transmitting with MAIN icon on the display. To select MAIN band press left or right volume knob. Press PTT key on microphone to transmit on the MAIN band.

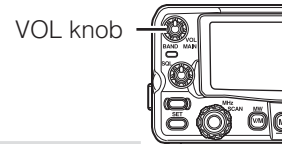

NOTE

To transmit on sub band without switching MAIN, set SUB-PTT switch on EMS-78 microphone for TX in set mode. (P.45)
During memory scan (P.59), receiving band becomes MAIN band automatically.

Switching operation band

Press and hold VOL knob to change the band (frequency). By pressing and holding VOL knob, VHF->Air-Band (Aviation-band) VHF->UHF appears on the display.

Also selecting same band for both left and right is possible. (V-V or U-U reception)

[AM] appears on the display when Air-band is selected as factory default setting.

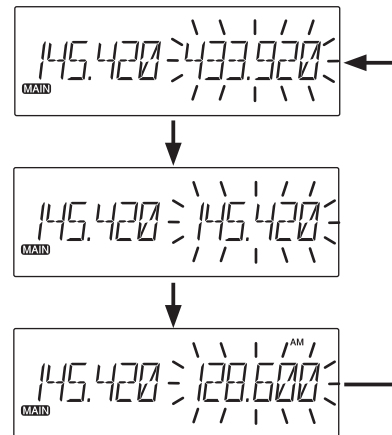

IMPORTANT

When V-V/U-U/V-Air-band is selected, during transmission on main band, reception on sub band becomes mute.

Audio level setting

The volume of the left band is adjusted by the left VOL knob and the volume of the right band by the right VOL knob.

Rotate the VOL knob clockwise to increase the audio level, counterclockwise to decrease.

Low Volume High Volume Low Volume High Volume

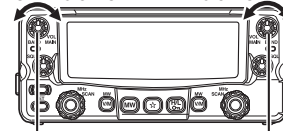

VOL knob for left band

VOL knob for right band

Squelch level setting

Adjust threshold level of the squelch. A squelch eliminates the background noise when a signal is not received.

Turn the SQL knob clockwise until white-noise (the background noise when a signal is not received) and [BUSY] icon on the display disappears.

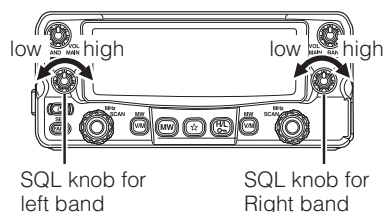

The SQL should be turned fully counterclockwise when receiving weak or unstable signals. The [BUSY] icon appears on the display while the squelch is opened (unmuted).

When you set it to a higher level, weak signals would be interrupted while monitoring or would not be monitored at all.

Generally, you should set the squelch to the lowest level where noise would be eliminated. Depending on the monitored frequencies and the conditions of the circumstances around you, the squelch level may need to be adjusted.



Attenuator function is assignable to the SQL knob. (P.44)

VFO mode

VFO tuning is set as the default mode at the factory. VFO (variable frequency oscillator) allows you to change the frequency in accordance with the selected channel step as you rotate the dial or by using the UP/DOWN keys on the microphone.

VFO mode is also used to program the data to be stored in the memory channels or to change the parameter settings of the radio.

Changing frequency by channel step

1. Select VFO mode by pressing V/M key

Press V/M key to switch between VFO mode and memory mode.

VFO mode : Frequency appears on the display.

Memory mode : Memory (channel) number or channel name appears on the display.

If memories have not been programmed, the unit cannot be switched to the memory mode.

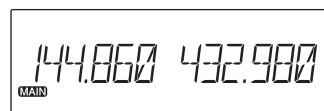

VFO mode

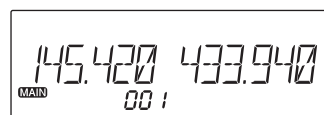

Memory mode

2. Changing frequency

Rotate the dial clockwise or UP key on the microphone to increase the frequency, and counterclockwise or DOWN key on the microphone to decrease the frequency.

In accordance with the selected tuning step in Set mode, frequency will be increased or decreased.

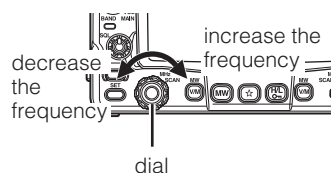



NOTE

- Dial and VOL are potentiometers with push-switch built in, therefore compared to SQL, you may feel rattling on knobs but it's not a defect.
- When using UP/DOWN keys to change the frequency, a different tone of beep sounds to inform which direction the frequency is moving. When it passes the 500kHz order, another beeps sounds. When the frequency starts moving, release UP/DOWN keys to start scanning. Press PTT key to stop. Pressing and holding them for more than 2 seconds will continue to change the frequency as long as the UP/DOWN keys are pressed.

■ Changing frequency by 1 MHz step

This will enable a quick change of frequency in 1 MHz step:

1. **Press Dial knob. The digits after 100 kHz will disappear from the display.**
2. **Rotate the dial clockwise or UP key on the microphone to increase the frequency, counterclockwise or DOWN key on the microphone to decrease. To return press any key or PTT key on the microphone.**

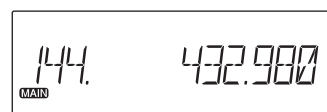

Tuning step selection

Tuning steps are the minimum frequency change increments when you rotate dial or push UP/DOWN keys on the microphone.

Factory default setting is [Auto] for left and right bands. Individual tuning steps setting is available to all 3 bands on the left and right sides. Details of steps and frequencies in AUTO mode are shown in Specifications at the end of this manual.

1. **Press V/M key to select the VFO mode. Tuning step selection is not available when the radio is in the memory mode.**
2. **Press and hold a VOL knob to select the band.**
3. **Press and hold FUNC key until menu number 01 appears on display.**
4. **Rotate dial knob to select tuning step.**
5. **Pressing any key except PWR key or dial knob on the unit will complete the setting and the display will return to VFO mode.**

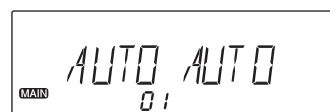

Channel step setting display (default)

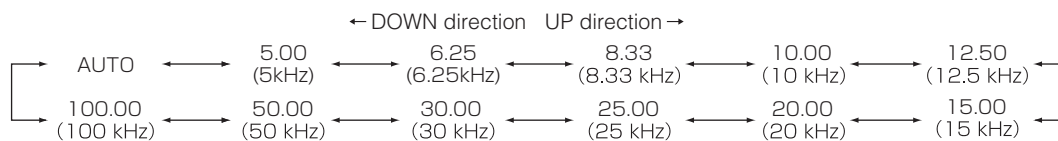

Example: Change VHF tuning step on the both left and right bands from 20 KHz to 10 KHz.

1. **Press and hold VOL knob to set left and right bands to VHF. Press and hold FUNC key, menu number 01 appears on the display (or press dial to select menu 1).**
2. **Rotate both left and right dial to adjust to 10 KHz.**
3. **Press PTT key on the microphone to save and return to VFO mode.**

 Individual setting is available for all 3 bands on the left and right bands. For example Air-band scanning is possible with 50 KHz tuning step on the left band and 100 KHz tuning step on the right band.

Shift Direction and Offset frequency setting

Conventional repeaters are operated in the DUPLEX mode, which receives an incoming signal on one frequency and re-transmit on another. The difference between these two frequencies is called offset frequency. The offset is variable between 0 to 99.995MHz on this unit.

1. **While pressing and holding FUNC key, press press VOL key of the side you wish to operate. The display will show the current status of the offset frequency and the shift direction. By repeatedly pressing the VOL knob, shift direction will be changed as shown.**
2. **Rotate the dial or press UP/DOWN key to select the offset frequency in accordance with a channel step of the VFO mode.**

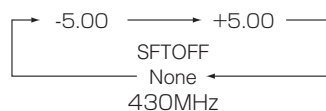
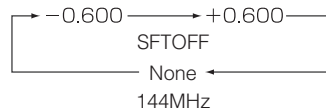
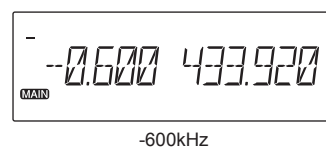

3. **After pressing the dial knob, rotating the dial will change the frequency by 1Mhz depending on which direction the dial is rotated (or if the UP/DOWN keys on microphone is pressed).**
4. **Pressing the PTT key or any key except VOL and dial knob will complete the setting and the display will return to the original status.**



The shift setting and operation is temporary possible in the memory mode. However, shift setting will be deleted when you change the channel, turn off etc.

Memory Mode

This mode allows recalling and operating the preprogrammed frequency or setting. This unit provides up to 1000 common memory channels on the left and right bands. (000 to 999CH) , 100 dual memory channels (d00 to d99 CH), 5 pair of program-scan memory (P1A/P1b to P5A/P5b), 1 pair of VFO auto-program memory scan, 1 CALL channel each for V and U (CALL), and 100 individual memory channels for V and U in advanced mode (L00 to L99 / r00 to r99).



Two type of memory channels are used in this radio.

- Common memory channels can be program and recall on both left and right bands.
- Individual memory channels are dedicated to left or right band only.

Individual memory channels provides as if operating two monoband radios' memory channels.

Programming memory channel (s)

1. **Select a frequency to be programmed in the VFO mode and set the parameters as appropriate. Refer to the next page for programmable parameters.**
2. **By Pressing FUNC key, [FUNC] and [Memory number] icons will appear on the display.**
3. **Rotate the dial (or press UP/DOWN keys on microphone) to select desired memory channel number.**

An empty channel is shown with a flashing [Memory number] icon.

- By pressing V/M key while [FUNC] icon is on the display, programming will be completed and you will hear a beep sound.

IMPORTANT

Be certain memory protect function in set mode is off to edit the memory channels.

Easy memory programming mode

One-touch programming is possible if you don't care selecting specific memory channel Number.

Select a frequency to be programmed in the VFO mode and set the parameters as appropriate. Refer to the below for programmable parameters.

Press and hold MW key until a beep sounds, the current setting will be stored in an empty memory channel of the lowest number and the number flashes 2 times.

Programmable data in the memory channel

Each memory channel including 000 to 999, d00 to d99, L00 to L99, CALL channel, APL/APH and POA/POb channels can store following:

- Frequency
- Output power
- Color setting
- Shift frequency
- Shift direction (+ / -)
- Tone encoder frequency
- Tone decoder frequency
- Tone encoder / decoder setting
- DCS code
- DCS setting
- Narrow mode setting
- AM mode setting
- Bell setting

Recalling a memory channel

- Select the memory mode by pressing V/M key.

Repeat to switch between memory and VFO mode.

- Select a memory channel.

Rotating dial (or pressing UP/DOWN keys on microphone) will increase or decrease a memory channel number by 1 channel step.

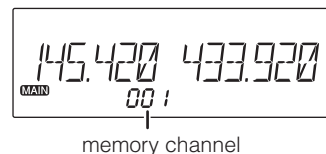

memory channel

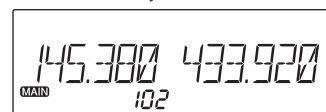



NOTE

- If memory channels have not been programmed, the unit will not be switched to the memory mode by pressing V/M key.
- Common memory channels will recall by pressing V/M key on the left or right side, for Individual memory channels left V/M key will recall left individual memory channels and right V/M key will recall right individual memory channel.
- In memory mode only programmed channels will appear on the display.

Overwriting memory channels

Overwriting memory channel data is possible in memory mode.

1. **Select desired channel and change the data such as output power, Tone, DCS, Shift, etc.**
2. **Press FUNC key and while [FUNC] is displayed, press the dial knob of the desired side.**

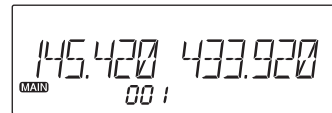

NOTE

When memory protect function is on (set mode menu 17), this operation becomes prohibited.

Erasing Memory channels

1. **Select the memory mode by pressing the V/M key.**
2. **Select the desired memory channel to be deleted by rotating the dial.**
3. **By pressing FUNC key together with the V/M key, a beep will sound and the memory will be deleted. At the same time, [Memory number] icon will start flashing.**

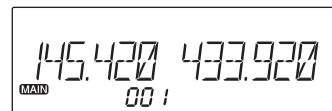

Memory mode

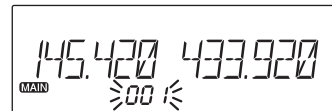

NOTE

Press FUNC key together with V/M key while memory channel is flashing to cancel memory channel deleting.

Copying memory data to VFO (Except dual-memory channels)

1. Select memory mode and desired memory channel to copy to the VFO.
2. Press VOL knob until hearing the beep sound.
3. Press V/M key to switch to VFO mode.

Dual Memory Function

Programming dual memory channel

1. Select a frequency to be programmed in the VFO mode and set the parameters as appropriate.
2. Press and hold FUNC key and MW key together until a beep is heard and d00 appears.
d** appears on the display.
3. Rotate the dial (or press UP/DOWN keys on microphone) to select desired memory channel number.
4. An empty channel is shown with a flashing [Memory number] icon.
5. By pressing MW key while [Memory number] icon is flashing on the display, programming will be completed and you will hear a beep sound.

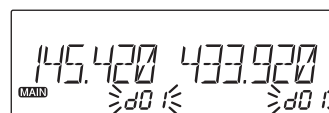

Recalling dual memory channel

You need to program at least one dual memory channel to perform this operation.

1. **Select the dual memory mode by pressing MW key.**

Press MW key to switch between VFO mode and dual memory mode (or memory mode and dual memory mode).

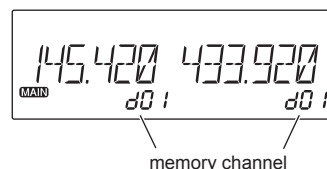

2. **Select dual memory channel.**

Rotating dial (or pressing UP/DOWN keys on microphone) will increase or decrease dual memory channel number.

Overwriting dual memory channel

Overwriting dual memory channel data is possible in dual memory mode.

1. **Select desired dual memory channel and edit data such as output power, Tone, DCS, Shift, etc.**
2. **Press and hold MW key to overwrite the data into dual memory channel.**

Erasing dual memory channel

1. **Select the dual memory mode by pressing the MW key.**
2. **Select the desired dual memory channel number by rotating the dial.**
3. **By pressing and holding FUNC key together with the MW key and holding, a beep will sound and the memory will be deleted. At the same time, [Memory number] icon will start flashing.**

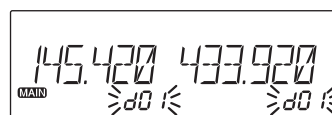

NOTE

Press FUNC key together with MW key while memory channel is flashing to cancel memory channel deleting.

Channel name (Alphanumeric) registration function

The memory channel stored in the common memory, individual memory, dual memory and program scan memory can be displayed with an alphanumeric tag instead of the default frequency display. There are 67 characters available including A-Z, 0-9.

1. **Select memory mode on the MAIN band and then select a channel to be programmed.**
2. **Press H/L key while pressing and holding the FUNC key.**
3. **The display shows [A] flashing.**
4. **Rotate the dial on the MAIN side to select a character to be programmed.**

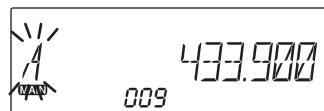

5. **By pressing the dial knob, the character stops flashing and is entered.**

An identical character to the one just entered flashes on the immediate right, ready to be edited.

6. **Enter the next character by repeating above 4 and 5 up to 6 digits.**
7. **Press and holding the dial knob during programming will delete all characters to be programmed.**
8. **Pressing any key other than the dial knob will complete the setting and the display will return to the original status.**

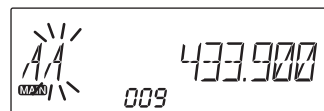

NOTE

Press FUNC key to display frequency. Memory channel number remains displayed. Press PTT to return to show the channel name.

Any key operation will also stop displaying the frequency and works as assigned.

Some examples of available characters. More symbols and characters are available.

| | | | | | | | | | | | |
|---|---|---|---|---|---|---|---|---|---|---|---|
| A | A | H | H | O | O | V | V | 0 | 0 | 7 | 7 |
| B | B | I | I | P | P | W | W | 1 | 1 | 8 | 8 |
| C | C | J | J | Q | Q | X | X | 2 | 2 | 9 | 9 |
| D | D | K | K | R | R | Y | Y | 3 | 3 | | |
| E | E | L | L | S | S | Z | Z | 4 | 4 | | |
| F | F | M | M | T | T | | | 5 | 5 | | |
| G | G | N | N | U | U | | | 6 | 6 | | |

Memory Bank Function

The DR-735 has a total of 10 banks (01 to AL). 1000 memory channels other than dual memory channels are assigned into the desired banks for easy memory management.

1. **After programming common memory channels, press V/M key of desired side to select memory mode.**
2. **Press and hold V/M key of the same side. A memory channel appears on the operating side, BNK** appears on the other side.**
3. **Select the memory channel and the bank number by rotating the respective dials. Programmed channels and banks are shown firm, while programming channels and banks are flashing.**
4. **Pressing and holding the memory channel side of the dial to program. A beep is heard. Repeat the same to cancel.**

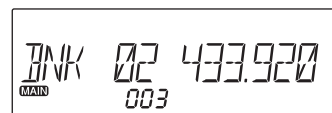
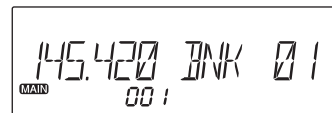

- Select the bank you wish to operate and press any key to return to the memory mode in BANK setting. Only programmed memory channels are available.
- To operate the bank memory mode, in the memory mode, press the dial and rotate it to select desired bank number. Press the same dial to operate. To use all memory channels, repeat above and select BNK AL.



[BNK AL] used for recalling all memory channels can not to be edited.

CALL Channel

This is a memory mode that allows the radio to quickly recall the assigned memory channel by simply pressing a key, in VFO mode.

The default setting is 145.00MHz/435.00MHz as E-model, 145.000MHz/445.000MHz as T-model, and one CALL channel is available on each band.

Recalling CALL Channel

1. **Press and hold the V/M key in VFO mode. The [CAL] icon appears on the display and recalls the CALL channel.**

In this mode, the main dial or UP/DOWN keys on the microphone cannot change the frequency or memory channels.

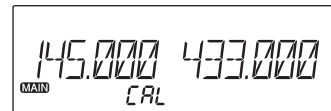

2. **Press V/M key to exit CALL mode and return to VFO mode.**



No scan functions are available in the CALL mode.

Editing CALL channel data

To store a desired setting in the CALL channel, follow the memory mode programming instructions and assign your selected settings to memory channel CAL. The call channel data can be modified but cannot be eliminated or hidden.

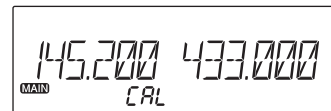

To receive signals

1. **Be sure to have the unit connected to an appropriate antenna, powered on, set the audio volume and squelch level properly on both the MAIN and SUB bands.**
2. **Select the desired band and browse frequencies or select desired frequency to listen to ongoing communications. The S-meter shows relative signal strength when the radio detects an incoming signal, and the RX indicator lamp (green) turns on.**
3. **If the S-meter indicates an incoming signal but nothing is heard from the speaker, check the audio level, squelch level, and CTCSS/DCS decoding status.**

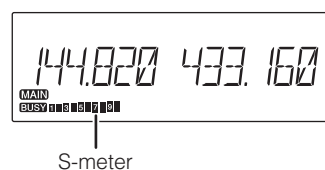

Monitor Function

This function is used to listen to weak signals. The monitor function operates irrespective of Tone squelch / DCS functions setting.

1. **Select desired band as MAIN. Press FUNC key then press MW key while [FUNC] appears on the display.**

Regardless of squelch level, Tone squelch and DCS setting, squelch on the MAIN side will open.

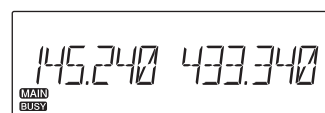

2. **Press any key on the front panel to exit.**

IMPORTANT The Monitor function only operates on the MAIN band.

Reverse Function

This function is to monitor the transmitting frequency instead of receiving frequency in repeater operation. This technique is commonly used to check if it is possible to communicate without using repeater by monitoring the accessing station's signal strength.

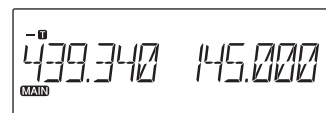

Auto repeater setting

1. **Set SHIFT first. Press FUNC key then press MW key while [FUNC] appears on display.**

[] icon appears on the display to indicate that the reverse function is activated and the squelch opens.

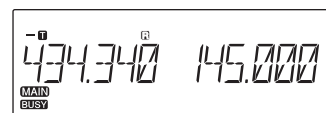

2. **Pressing any key on the front panel will cancel the operation.**

IMPORTANT

The Reverse function only operates on the MAIN band.

Without SHIFT setting Monitor function will operate instead of Reverse function.



NOTE

Rotate squelch knob counterclockwise to monitor repeater's down link.

In case tone squelch or DCS decoding is used, it is necessary to turn off these functions to monitor.

To Transmit

1. **Set the transmitting band to the MAIN side.**

2. **Check the system and monitor the frequency to make sure that you are not going to disturb any ongoing communications.**

3. **Press the PTT key on the microphone.**

The TX lamp (red) illuminates to show the unit is transmitting.

4. **Speak into the microphone in a normal voice while keeping the PTT key pressed.**

Hold the microphone approximately 5cm away from your mouth. Speaking too close or too loud may result in poor audio. Adjust microphone gain in set mode (Menu 03) when necessary.

TX lamp

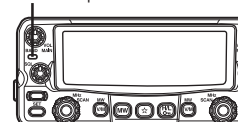

5. **Releasing the PTT key will complete the transmission and the unit will return to the receive mode.**



Pressing the DOWN key together with the PTT key will transmit the Tone Burst signal.
Pressing the UP key with PTT key to transmit the Auto-dialer tones.

IMPORTANT If you press the PTT key while out of the transmission frequency range, the [OFF] icon will appear on the display and no transmission will occur.

Selecting Output Power

1. **Press H/L key. The Output power switches among High, Middle and low.**

At middle power, the [M], and at low power, the [L] illuminates. Nothing appears on the display at high power. The default is high power.

The RF meter shows 1 1 3 when transmitting at low power, and 1 1 3 5 at middle power, and 1 1 3 5 7 9 at high power.

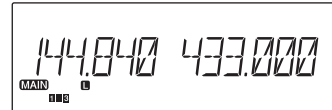

at low power

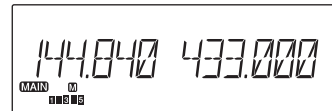

at middle power

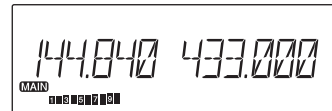

at high power

| Transmission Power | VHF | UHF |
|--------------------|-----|-----|
| HI | 50W | 50W |
| MID | 20W | 20W |
| LOW | 5W | 5W |

IMPORTANT

- The output power level cannot be changed during transmission.
- The output power level cannot be changed during scanning.



The Middle output setting is adjustable in set mode (P.54); however, RF-meter level indication will remain unchanged.

Set mode

The set mode is used to customize the features available in this radio.
The selectable features are called menu, its values and settings are called parameters.

Please read the following pages thoroughly prior to changing any parameters.

A list of setting mode Menus and parameters

Copy the list below and carry with the radio for your convenience.

| Menu | Default Display | Function | Default Value |
|------|-------------------|--|---------------|
| 01 | AUTO AUTO | Channel Step setting | AUTO AUTO |
| 02 | AUTO AUTO | Modulation mode | AUTO AUTO |
| 03 | MCGAIN 0dB | Microphone gain adjustment | 0dB |
| 04 | BUSY BUSY | Scan type selection | BUSY BUSY |
| 05 | SKIP SKIP | Memory scan mode selection | SKIP SKIP |
| 06 | BEEP 2 | Beep sound level selection | 2 |
| 07 | VFO - BP ON | VFO beep ON/OFF | ON |
| 08 | BEL - OF BEL - OF | Pager ON/OFF | OFF OFF |
| 09 | CLMODE ALL | Color mode selection | ALL |
| 10 | SB CL0 SB CL0 | Display color selection for Stand-by | CL0 CL0 |
| 11 | RX CL0 RX CL0 | Display color selection for Receiving | CL0 CL0 |
| 12 | TX CL0 TX CL0 | Display color selection for transmitting | CL0 CL0 |
| 13 | DIMMER 10 | Dimmer level setting | 10 |
| 14 | LAMP OFF | Display illumination timer | OFF |
| 15 | CN TRST 3 | Contrast setting | 3 |
| 16 | ATT - OF ATT - OF | Attenuator setting | OFF OFF |
| 17 | MPRTCT OFF | Memory protection | OFF |
| 18 | SUBPTT OFF | Sub PTT assignment | OFF |
| 19 | KEY 2 | Key-holding time setting | 2 |
| 20 | AUTRPT ON | Auto repeater shift | ON |
| 21 | RESTOR OFF | Restore function | OFF |

To operate the Set mode

IMPORTANT

Some parameters are assigned to only left or right band and some of the parameters are not changeable. For details please refer to explanation of each menu in following pages.

Some parameters are available only in VFO mode, or affects only temporary when operated in the memory mode.

1. **Press and hold FUNC key to enter the Set mode. Menu number and parameter will appear on the display.**

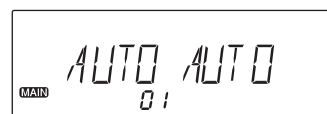

Default display

2. **Select a menu by pressing left dial knob to decrease menu number or right dial knob to increase menu number. Press and hold the dial to automatically switch the menu number.**
3. **Rotate the dial to change settings.**
 Rotate left dial to change parameters on left side and right dial for right side.
 Only the right dial may be available for certain menus.
 A beep will sound when the left dial is operated in such menu.
4. **Pressing dial or UP/DOWN keys on the microphone will save the setting and enter the next menu.**
5. **Pressing any key other than the dial and UP/DOWN keys will complete the setting and the unit will exit the Set mode.**

preference

A variety of features are available in the set mode menu. Please operate all menu to learn how they work before you set the parameters of your. After learning and practicing all available features, reset the radio by referring to P.75 then customize the parameters of your preference.

Set mode menu

Menu 01. Channel Step setting

This is to select the channel step to be used in the VFO mode. Details are already explained in P.21. The values are variable only in the VFO mode. Warning beep sounds when operated in the memory mode.

Menu 02. Modulation mode

This is to select the operating modulation mode. AM mode is not available for transmitting. A narrow FM mode is becoming popular in amateur radio, and is also used in VoIP communications.

The modulation level becomes half in narrow mode and receiving audio level increases. The mode selection is stored independently for each band and memory channel.

This operation is possible in the memory mode but the change affects only temporary.

1. **Press and hold FUNC key to enter the set mode. Press dial to select menu 02. Factory default setting is [Auto].**

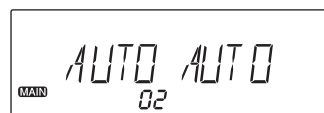

2. **Rotate the dial to select FM, NFM, AM or NAM. When NFM or NAM selected, Nar will appear on the display.**

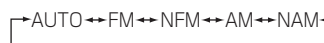

3. **Repeat the same operation by selecting another side of VFO if the same mode is always desired when operating the same band.**
4. **Press any key to set and exit, or press the dial or UP/DOWN keys to set and move to another menu.**

Menu 03. Microphone gain adjustment

1. **Press and hold FUNC key to enter the set mode. Press dial to select menu 03. Factory default setting is [0dB]. This value becomes effective regardless of the band or VFO.**

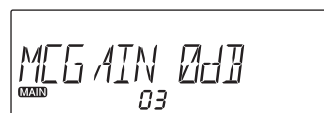

2. **Rotate the right dial to select a value between -23dB and +23dB. Selecting (-) will decrease and (+) will increase microphone gain. The microphone gain is adjustable while transmitting.**

3. Press any key except PTT to set and exit, or press the dial or UP/DOWN keys to set and move to another menu.

IMPORTANT Pressing PTT switch will not exit the set mode setting in this menu.

Menu 04. Scan type selection

This is to select the scan resume condition. The BUSY setting resumes scanning when received signal is gone and the TIME setting allows the radio to resume scanning after 5, 10, 20,30 or 60 seconds. This parameter can be selected for both left and right VFO but cannot be selected for each band.

1. Press and hold FUNC key to enter the set mode. Press dial to select menu 04. Factory default setting is [BUSY].

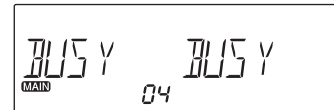

2. By rotating the dial, the display changes as shown.
3. Select a desired parameter.
4. Repeat the same operation by selecting another side of VFO if the same mode is always desired whichever the VFO you use.



5. Press any key to set and exit, or press the dial or UP/DOWN keys to set and move to another menu.

Menu 05. Memory scan mode selection

Use this function to select memory scan conditions. (P.59)

This parameter can be selected for both left and right VFO but cannot be selected for each band.

1. Press and hold FUNC key to enter the set mode. Press dial to select menu 05. Factory default setting is [SKIP].

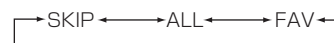
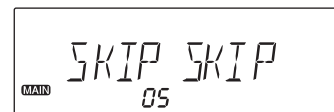

2. Rotate the dial to select a desired parameter.

SKIP : Memory-scans skipping SKIP channels.

ALL : Scans all memory channels regardless of SKIP/FAV setting.

FAV : Memory-scan only favorite channels.

3. Press any key to set and exit, or press the dial or UP/DOWN keys to set and move to another menu.

Menu 06. Beep sound level selection

This is to select the audio level of the beep sound during operations.

1. Press and hold FUNC key to enter the set mode. Press dial to select menu 06. Factory default setting is [2].

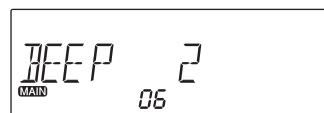

2. Rotate the dial to hear the beep sound level and set it to your preference. This setting affects regardless of bands and VFOs.

3. Press any key to set and exit, or press the dial or UP/DOWN keys to set and move to another menu.

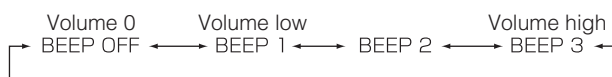

Menu 07. VFO beep ON/OFF

A beep sounds at 500KHz/1MHz order while scanning or selecting the frequency. Such beep can be muted.

1. **Press and hold FUNC key to enter the set mode. Press dial to select menu 07. Factory default setting is [ON].**
2. **Rotate the right dial to select a desired parameter. This setting affects regardless of the band or VFO.**
3. **Press any key to set and exit, or press the dial or UP/DOWN keys to set and move to another menu.**

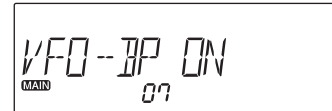

Menu 08. Pager ON/OFF (BELL feature)

A pager (BELL) informs you that you are being called by sounding a bell, and flashing the bell icon on the display.

1. **Press and hold FUNC key to enter the set mode. Press dial to select menu 08. Factory default setting is [OFF]. This parameter can be selected for both left and right VFO but cannot be selected for each band.**
2. **Rotate the dial of desired side to select ON to activate, OFF to deactivate.**
3. **Press any key to set and exit, or press the dial or UP/DOWN keys to set and move to another menu.**

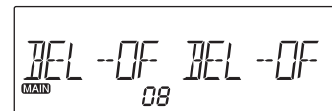

When BELL is on:

- Bell icon appears on the display.
- When squelch becomes open, bell icon will flash and a beep sounds.
- No beep will sound during communications.
- After 10 seconds since receiving signal is gone, BELL feature resumes. The bell icon stays flashing until any key may be operated.

Menu 09. Color mode selection

This is the mode to select color mode for various conditions.

This is to determine the display color assignment of Stand-by, Receiving and Transmitting status to be set in the following menu 10 to 12.

1. **Press and hold FUNC key to enter the set mode. Press dial to select menu 09.**

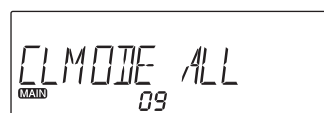

2. **By rotating the right dial, the display changes as shown.**

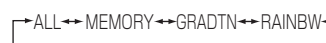

3. **Press any key to set and exit, or press the dial or UP/DOWN keys to set and move to another menu.**

ALL : This is to fix the colors of the left and right side of the display, regardless of the bands, MAIN/SUB setting or VFO/memory modes. This is suitable for users who do not care details, but just use a fixed color setting on the left and right side of the display.

MEMORY : This is for users who prefer to fix the colors in accordance with bands, regardless of the side of the display, or to use programmed color parameters in memory channels.

Like channel steps and modulation mode settings, left/right and bands can be set independently, and programmed into the memory channels.

GRADTN : Gradation mode. Color on the display changes automatically.

RAINBW : Rainbow colors will move from left to right.



NOTE

GRADTN and RAINBW mods are fixed and not available for customization being or programmed into memory channels.

Menu 10. Display color selection for Stand-by

1. Press and hold FUNC key to enter the set mode. Press dial to select menu 10 to set the display color of Stand-by state.

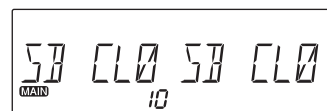

2. Rotate either left or right dial you wish to edit the display color. The color selection is affected immediately. See the list below for available colors in menu 10 ~ 12.

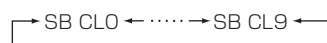

3. Press any key to set and exit, or press the dial or UP/DOWN keys to set and move to another menu.

CL0: White CL5: Purple
 CL1: Red CL6: Light Blue
 CL2: Green CL7: Orange
 CL3: Blue CL8: Pink
 CL4: Yellow CL9: Light Green



NOTE

By operating RGB color setting on P.63, CLA ~ CLF parameters will be added in menu 10, 11 and 12..

Menu 11. Display color selection for Receiving

1. Press and hold FUNC key to enter the set mode. Press dial to select menu 11 to set the display color of Receiving state.

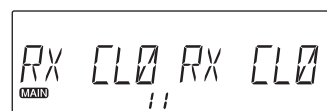

2. Rotate either left or right dial you wish to edit the display color. The color selection is affected immediately.

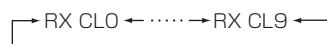

3. Press any key to set and exit, or press the dial or UP/DOWN keys to set and move to another menu.

Menu 12. Display color selection for transmitting

1. Press and hold FUNC key to enter the set mode. Press dial to select menu 12 to set the display color of Transmitting state.
2. Rotate either left or right dial you wish to edit the display color. The color selection is affected immediately.
3. Press any key to set and exit, or press the dial or UP/DOWN keys to set and move to another menu.

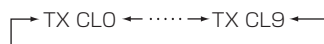
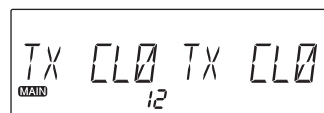

Menu 13. Dimmer Level setting

Select the brightness of the display. 10 is brightest, 0 is dim.

1. Press and hold FUNC key to enter the set mode. Press dial to select menu 13.
2. Rotate the right dial to select the brightness you like. The level 10 is brightest, level 0 is dim.
This value becomes effective regardless of band and VFO.
3. Press any key to set and exit, or press the dial or UP/DOWN keys to set and move to another menu.

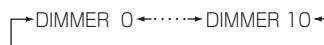
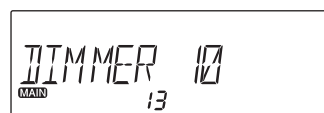

Menu 14. Display illumination timer

The display illuminates brighter for a period of time set in here. The brightness is 5 levels higher than the value set in menu 13. This value becomes effective regardless of band and VFO.

1. **Press and hold FUNC key to enter the set mode. Press dial to select menu 14.**
2. **Select a timer value by rotating the right dial. Available parameters are shown below.**
3. **Press any key to set and exit, or press the dial or UP/DOWN keys to set and move to another menu.**

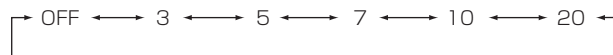
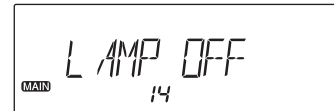

NOTE

Select the dimmer level 0 in previous menu, so that the display illuminates only when a key is operated except PTT. This setting may be comfortable while driving at night.

Menu 15. Contrast setting

This is to set the contrast value of displayed characters. The change may not be very obvious depending on the display color you selected.

1. **Press and hold FUNC key to enter the set mode. Press dial to select menu 15. Factory default setting is [3].**
2. **Select a value by rotating the right dial. Available parameters are 1 to 5. This value becomes effective regardless of band and VFO.**
3. **Press any key to set and exit, or press the dial or UP/DOWN keys to set and move to another menu.**

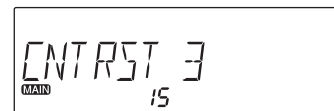

Menu 16. Attenuator setting

Attenuator reduces sensitivity intentionally. When a very strong signal is being received in near-by frequency, it may interfere the signal you are receiving. By reducing the sensitivity, such interference may be gone.

1. **Press and hold FUNC key to enter the set mode. Press dial to select menu 16.**

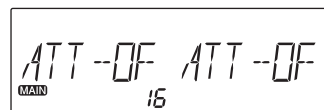

2. **Rotate either left or right dial to set the parameter. Available parameters are shown below.**

This function is assignable to left and right VFOs separately, but not to each band.

3. **Press any key to set and exit, or press the dial or UP/DOWN keys to set and move to another menu.**

- OFF : Attenuator function is disabled.
- SQ : The attenuator functions in relation with the squelch level. Rotate the dial clockwise until ATT is displayed and to obtain an appropriate level. The maximum level is about 10dB.
The squelch level remains at a center-position of the squelch knob while ATT is activated.
- ON : 10dB attenuation is activated always. When attenuator is ON, ATT appears on the display.

Menu 17. Memory protection

This is to prevent important data from being deleted or overwritten accidentally.

1. **Press and hold FUNC key to enter the set mode. Press dial to select menu 17.**
Factory default setting is [OFF].



2. **Rotate the right dial to select ON or OFF.**
OFF allows overwriting and editing the memory channels, ON to prohibit. This setting becomes effective regardless of bands and VFOs.
3. **Press any key to set and exit, or press the dial or UP/DOWN keys to set and move to another menu.**



Memory reset (P.75) will delete memory channels data even when memory protection is set ON.

Channel data can be temporary edited during operations even the protection is ON, but won't be stored and will reset to original data when you turn off or move to another memory channel.

Menu 18. Sub PTT assignment (Only EMS-78)

This is to allocate desired function to the sub PTT key on EMS-78 microphone.

1. **Press and hold FUNC key to enter the set mode. Press dial to select menu 18.**
2. **Rotate the right dial to select a parameter. This setting becomes effective regardless of bands and VFOs.**
3. **Press any key to set and exit, or press the dial or UP/DOWN keys to set and move to another menu.**



OFF : Sub PTT deactivated (Sub PTT not in use).

SUB TX : To transmit on the SUB band frequency.

MID TX : To transmit MAIN frequency in MID output power always.

LOW TX : To transmit MAIN frequency in LOW output power always.

MAIN TX : Functions the same as main PTT.

M MONI : To squelch-off (monitors) MAIN band.

M BAND : To switch MAIN band.

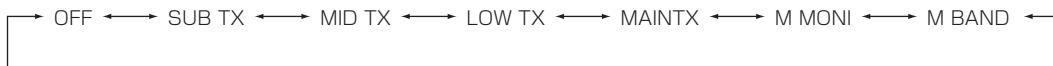

Menu 19. Key-holding time setting

This is to change the time for pushing and holding keys. Shorter value allows faster operations, but may cause erroneous key operations. This value affects press-and-hold key operations such as key-lock, activating scans, memory programming etc.

1. **Press and hold FUNC key to enter the set mode. Press dial to select menu 19. Factory default setting is [2] seconds.**

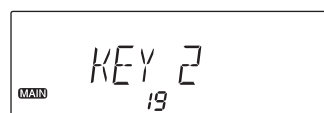

2. **Rotate the right dial to select a value. Available values are 1 to 5 in seconds. This setting becomes effective regardless of bands and VFOs.**

3. **Press any key to set and exit, or press the dial or UP/DOWN keys to set and move to another menu.**

Menu 20. Auto repeater shift

When the operating frequency is tuned within the band shown below in VFO mode, a repeater shift will apply automatically.

1. **Press and hold FUNC key to enter the parameter set mode. Press dial to select menu 20.**



2. **Rotate the right dial to select a parameter, ON to activate, OFF to deactivate. This setting becomes effective regardless of bands and VFOs.**

3. **Press any key to set and exit, or press the dial or UP/DOWN keys to set and move to another menu.**

| | Lower limit in MHz | Upper limit in MHz | Shift width & direction |
|---|--------------------|--------------------|-------------------------|
| T | 145.100 | 145.500 | -600KHz |
| | 146.610 | 147.000 | -600KHz |
| | 147.000 | 147.400 | +600KHz |
| | 442.000 | 445.000 | +5MHz |
| | 447.000 | 450.000 | -5MHz |
| E | 145.600 | 145.800 | -600KHz |



Use VFO auto program to customize auto repeater setting (See page 57)

Menu 21. Restore function

This is to restore most parameters being set in the set mode. This function recalls most parameters even after a reset is being performed, allowing you to recover them quicker. It is recommended that you use this function after the setmode setting is completed to suit your preference.

IMPORTANT Color setting and some other setting out of set mode cannot be restored. Color display and some other parameters that may relate to non-set mode setting can't be restored and recalled.

1. **Press and hold FUNC key to enter the set mode. Press dial to select menu 21. Factory default setting is [OFF].**

RESTOR OFF
MAIN 21

2. **Rotate the right dial to select SAVE and then press and hold FUNC key until hearing the beep.**

RESTOR SAVE
MAIN 21

3. **The data is restored and exits the set mode.**

RESTOR YES
MAIN 21

4. **To recall restored data, repeat above 1 and select YES, then press and hold FUNC key until hearing the beep.**

RESTOR DELETE
MAIN 21

The data is recalled, turns off then turns on automatically.

5. **Reset function will not delete restored setting data. Simply repeating “YES” operation won’t overwrite the restored data either. In order to change the restoring data, repeat the operation and select DELETE then press and hold FUNC key until a beep is heard. Repeat to “SAVE” operation to store new data.**

IMPORTANT Memory channel restore function is not available. It is recommended that you use DR-735 clone-utility to recall memory channels and/or detailed customized setting.

Advanced set mode

The DR-735T/E has an advanced set mode which is used for even more detailed customizations. Available menus are mostly "set-and-forget" so this mode can be hidden.

A list of the advanced set mode menus and parameters

| Menu | Default Display | Function | Default Value |
|------|-------------------|---|---------------|
| 22 | APO OFF | Auto power off (APO) | OFF |
| 23 | TOT OFF | Time out timer (TOT) | OFF |
| 24 | TOTP OFF | TOT penalty | OFF |
| 25 | TB 1750 | Tone burst tones | 1750 |
| 26 | BCL - OF BCL - OF | Busy channel lock out (BCLO) | OFF OFF |
| 27 | S - MUTE OFF | SUB band mute during transmission | OFF |
| 28 | SCNLMP OFF | Scan illumination | OFF |
| 29 | FAN AUTO | Cooling fan operation | AUTO |
| 30 | VM 0 UM 0 | Mid power output | 0 0 |
| 31 | HTR - N HTR - N | Image signal rejection | N N |
| 32 | TNC OFF | TNC output | OFF |
| 33 | MEMORY COMMON | Memory channel mode selection | COMMON |
| 34 | AFMUTE OFF | Mutes SUB band RX while receiving in MAIN | OFF |

To use the advanced set mode

Press and hold H/L key until,  appears on the display. Within 10 seconds, press H/L key 5 times in a consecutive manner until beep is heard and a ★ icon appears on the display. The Menu 22 ~ 34 are added in the set mode menu. After being completed the advanced setting, you may repeat the same operation to hide the advanced menus. The saved values remain unchanged.

Menu 22. Auto Power OFF (APO)

This feature will automatically shut off the power. It is useful in mobile operation to avoid draining the car battery. If there is no activity or use of the radio, it will turn off automatically after selected time followed by a beep sound.

1. **Press and hold FUNC key to enter the set mode. Press dial to select menu 22.**
2. **Rotate the right dial to select a value in second as shown below. This setting becomes effective regardless of bands and VFOs.**
3. **Press any key to set and exit, or press the dial or UP/DOWN keys to set and move to another menu.**

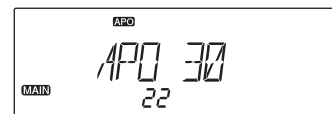
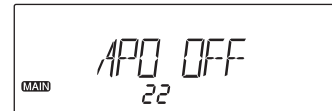

During the ON setting



Menu 23. Time out timer (TOT)

The TOT feature is popular in repeater systems. It prohibits users from transmitting on the repeater after a certain period of time has elapsed. By setting this function and activating it according to the repeater's requirement, the radio alerts the user by a beep 5 seconds prior to time-out. While the time is expired, transmitting stops and automatically returns to receive. Release PTT key once to resume transmitting.

1. **Press and hold FUNC key to enter the set mode. Press dial to select menu 23.**
2. **Rotate the right dial to select a value in second as shown below. This setting becomes effective regardless of bands and VFOs.**
3. **Press any key to set and exit, or press the dial or UP/DOWN keys to set and move to another menu.**

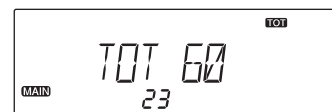

During the setting time of 60 seconds



Menu 24. TOT Penalty

When transmission is shut down in the TOT mode, this function prohibits another transmission during a selected TOT penalty period regardless of the PTT key being pressed. A beep sounds when the PTT key is pressed during the TOT penalty period.

1. **Press and hold FUNC key to enter the set mode. Press dial to select menu 24. Factory default setting is [OFF].**

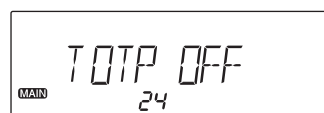

2. **Rotate the right dial to select a value in second as shown below. This setting becomes effective regardless of bands and VFOs.**

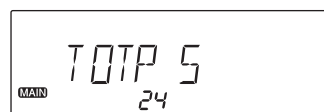

During the setting time of 5 seconds

3. **Press any key to set and exit, or press the dial or UP/DOWN keys to set and move to another menu.**

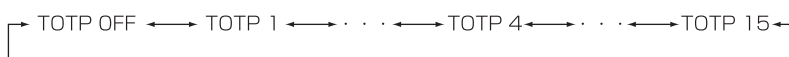

Menu 25. Tone burst tones

This is to access Tone burst repeaters which requires a certain pitch of audible tone to activate "sleeping" repeaters. Usually, a repeater system does not require the tone once the repeater is activated.

1. **Press and hold FUNC key to enter the parameter set mode. Press dial to select menu 25. Factory default setting is [1750].**

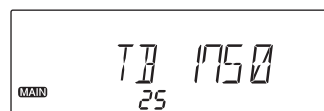

2. **Rotate the right dial to select a value in Hz as shown below. This setting becomes effective regardless of bands and VFOs. Alert is not a TB tone, but an intermittent tone you may use to attract attentions of your calling station.**

3. **Press any key to set and exit, or press the dial or UP/DOWN keys to set and move to another menu.**

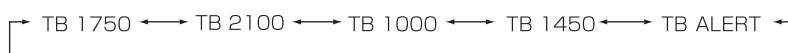

Menu 26. Busy channel lock out (BCLO)

This function prohibits transmission as long as there is a signal on the receiving frequency. The default is BCLO-OFF, which is the off position. By activating this function, the radio transmits only when:

1. No signal is received (BUSY icon is gone) on the receiving frequency.
 2. The tone-squelch is not opened by receiving the corresponding CTCSS tone.
 3. As above, with DCS code.
- Otherwise a beep sound and the unit does not transmit even when the PTT is pressed.

1. **Press and hold FUNC key to enter the set mode. Press dial to select menu 26. Factory default setting is [OFF].**

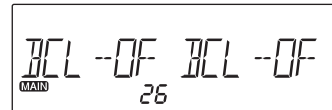

2. **Rotate either left or right dial you wish to set the BCLO feature. BCLO can be set separately in VFOs, but not for each band.**

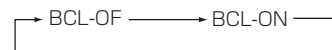

3. **Press any key to set and exit, or press the dial or UP/DOWN keys to set and move to another menu.**

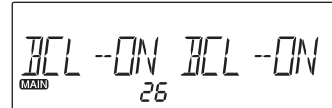

Menu 27. Sub band mute during transmission

This is to operate as a semi-duplex radio, muting the sub band audio while transmitting in the MAIN band.

1. **Press and hold FUNC key to enter the set mode. Press dial to select menu 27. Factory default setting is [OFF].**



2. **Rotate the right dial and select ON to activate, OFF to deactivate. This setting becomes effective regardless of bands and VFOs.**

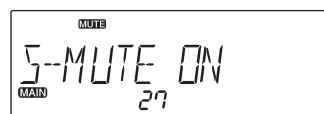

3. **Press any key to set and exit, or press the dial or UP/DOWN keys to set and move to another menu.**

Menu 28. Scan illumination

This is to illuminate the display at a maximum brightness for 2 seconds when a signal is detected during scanning. Dimmer level should be set darker in advance to utilize this feature.

1. **Press and hold FUNC key to enter the set mode. Press dial to select menu 28. Factory default setting is [OFF].**

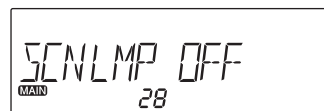

2. **Rotate the right dial and select ON to activate, OFF to deactivate. This setting becomes effective regardless of bands and VFOs.**

3. **Press any key to set and exit, or press the dial or UP/DOWN keys to set and move to another menu.**

Menu 29. Cooling fan setting

This is to select operation condition of the cooling fan. Please set it ON when the main unit is installed in less ventilated area.

1. **Press and hold FUNC key to enter the set mode. Press dial to select menu 29. Factory default setting is [AUTO].**

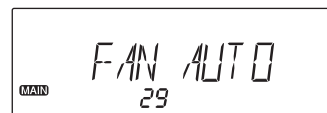

2. **Rotate the right dial and select a desired. This setting becomes effective regardless of bands and VFOs.**
3. **Press any key to set and exit, or press the dial or UP/DOWN keys to set and move to another menu.**

AUTO : Cooling fan turns when the main unit becomes hot, while transmitting and for 2 minutes after transmitting.

It turns off automatically when cooled down.

ON : Cooling fan turns continuously. It turns always while powered on.

HTEMP : It turns only when inside temperature exceeds above 70°C (158°F).

This parameter is only recommended while monitoring in a silent place by minimizing fan noise.

Menu 30. Mid output power

This is to customize the Mid output power. The setting is assignable to VHF and UHF bands, but not VFOs. Available levels are 21 and between 50 and 5 Watts. Default is zero, and represents 20W.

Use of a power-meter and a dummy load is recommended for accurate adjustment.

1. **Press and hold FUNC key to enter the set mode. Press dial to select menu 30.**

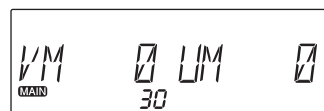

2. **Rotate the left dial for VHF, right for UHF. Negative icon represents lower output, positive for higher output. -10 is lowest (approx. 5 W), +10 is highest (approx. 50 W).**

You can transmit while tuning; use VOL knobs to switch MAIN band.

3. **Press any key other than PTT to set and exit, or press the dial or UP/DOWN keys to set and move to another menu.**

IMPORTANT

This operation is possible only in the transmitting range and a warning beep sounds otherwise.

Menu 31. Image signal rejection

This feature may eliminate interference caused by unwanted image signal being received such as hearing FM broadcast in amateur radio bands.



NOTE

This function is not a noise blanker and may not be effective in all cases of image signal interferences.

1. **Press and hold FUNC key to enter the set mode. Press dial to select menu 31. Factory default setting is [N].**

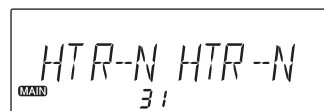

2. **Rotate either left or right dial you wish to apply change and select R (reverse).**

This is selectable separately in VFOs, but not for each band.

3. **Press any key other than PTT to set and exit, or press the dial or UP/DOWN keys to set and move to another menu.**

Menu 32. TNC mode

The DIN connector on rear panel outputs signals necessary to operate devices like external TNC and VoIP interface units in TNC mode.

IMPORTANT

Due to restrictions on the devices used in this radio, a data communication higher than 4800bps (like packet mode) is NOT possible, even the external device supports higher speed. TNC mode is available only to the RIGHT VFO.

1. **Press and hold FUNC key to enter the set mode. Press dial to select menu 32. Factory default setting is [OFF].**
2. **Rotate the right dial to select ON to activate TNC mode, OFF to deactivate. TNC icon appears when activated.**
3. **Press any key other than PTT to set and exit, or press the dial or UP/DOWN keys to set and move to another menu.**

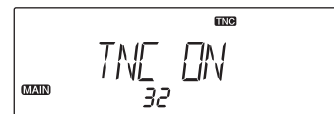

Menu 33. Memory channel mode selection

This is to select memory channel mode. 3 different modes are available.

1. **Press and hold FUNC key to enter the set mode. Press dial to select menu 33. Factory default setting is [COMMON].**



2. **Rotate the right dial to select desired memory mode as explained below.**

COMMON : Only using common memory channels (000 to 999)

L/R : Only using individual right and left memory channels (L00 to L99, R00 to R99)

ALL : Using both common and individual memory channels (000 to 999, L00 to L99/
R00 to R99)

3. **Press any key other than PTT to set and exit, or press the dial or UP/DOWN keys to set and move to another menu.**



NOTE

- Programmed memory channels won't be deleted by changing memory channel mode.

Easy memory programming is available in both COMMON and L/R modes.

In case ALL, easy programming is available only to COMMON channels.

Menu 34. SUB band mute

This is like a semi-duplex transceiver to mute the sub-band receive while receiving in the MAIN band.

1. **Press and hold FUNC key to enter the set mode. Press dial to select menu 34. Factory default setting is [OFF]. This setting becomes effective regardless of bands and VFOs.**

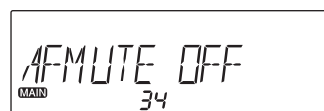

2. **Select On to activate, OFF to deactivate by rotating the dial.**

Useful functions

Single-band mode

This is to use the unit as a single-band radio by eliminating the display on the opposite side.

1. **Press FUNC key and while [FUNC] appears on the display, press VOL knob of the desired side to operate. The display of the opposite side will disappear.**
2. **Press the VOL knob of opposite side to switch the band to operate. Press FUNC then press a VOL knob to resume a dual-band operation.**



VFO Auto-program function

This is a "customized AUTO repeater" feature. Parameters set in this feature has a priority over the conventional AUTO-repeater setting, and can be activated both at the same time.

The parameters available for this functions are the upper/lower limit of the range, shift direction, offset width, and CTCSS/DCS encode/decode setting. (P.65)

1. **In VFO mode, tune to the lower limit frequency and set the offset direction/width, tone status as preferred. Press FUNC key and rotate the dial of the same VFO you operated to select APL. Press the V/M key of the same side to save.**
2. **Tune to the higher limit frequency, repeat above 1 to select APH and set. APH setting is valid only the frequency and other parameters will be disregarded. APH frequency should be higher than APL otherwise doesn't work. APL and APH can't accept temporary change of the programmed data.**
3. **Disable shift and tone settings operated in above 1. Move to the AUTO-program range and see if desired setting is automatically applied.**

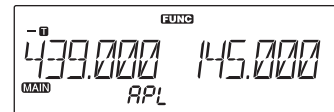

When 439.000MHz 88.5Hz
ENC-5.000MHz shift is set in APL

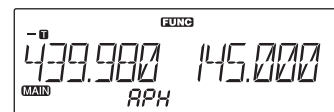

APH is set to 439.980MHz

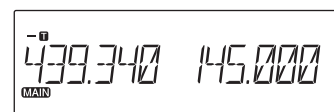

Shows an example within
VFO auto-program setting

4. **To turn off the VFO auto program, delete the APL memory data by referring to P.27**
You may disregard APH to turn off the function.

IMPORTANT

Shift, offset, CTCSS and DCS settings within the AUTO-program range cannot be changed manually when this feature is activated.

Scan Function

Use this function to automatically search for signals. In the set mode, chose TIMER mode or the BUSY mode to determine the desired resuming condition. If the CTCSS (TSQ) squelch or DCS squelch is set, the audio can be heard only when the tone / code matches the incoming signal. Otherwise, scanning stops but no audio will be heard and resumes scanning. The direction of scan, upward or downward, can be changed during the scan by rotating dial or pressing UP/DOWN keys on the microphone. Scan won't start when the squelch is open. When tone-squelched using CTCSS/DCS tones, scanning is possible but slowed down due to searching for matching tones every tuning steps.

■ Scan resume conditions (set in the set mode “Scan type selection”)

- BUSY: Resumes scanning when the receiving signal is gone and squelch is closed.
- TIMER: Resumes scanning in accordance with preset monitoring time regardless of presence of receiving signals.

■ Automatic Band Exchange Function (ABX)

This function automatically sets the receiving band as a MAIN band.

This is a specification of this radio due to technical reasons and can't be modified.

If the ABX won't allow you to transmit on desired band, exit from the scan mode and set the MAIN band manually.

VFO Scan

Scan all VFO channels in regard to the preset tuning step.

1. **Select the desired band to scan in VFO mode.**
2. **Press and hold the dial of scanning band until scanning starts . S icon flashes during scanning.**
Rotate the dial to change the scan direction. Key operations at the same side or pressing PTT will stop scanning.
3. **Pressing UP key (to scan upward) or Down key (to scan downward) also enables scanning. Press it until scanning starts and release immediately.**

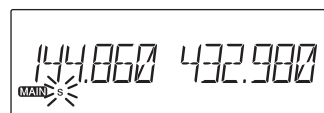

Holding UP/DOWN keys longer will change the frequency as long as the keys are being pressed.

To skip monitoring unwanted signal and continue scanning, rotate the dial or use UP/DOWN key to move to another frequency.

Memory Scan

1. Enter to the Memory mode of the desired band.
2. Operations are the same as VFO scan.

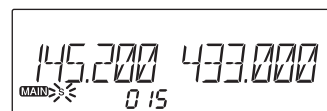

NOTE

In case the scanning is not performing as you expect, check the Skip and Favorite setting below and memory scan mode selection in the set mode.

Dual Memory Scan

1. Enter to the Dual-Memory mode.
2. Pressing and holding either left or right dial will start scanning, in accordance with the scan mode assigned to the operated side.
In case of UP/DOWN key operation, scan mode will depend on the MAIN-side.

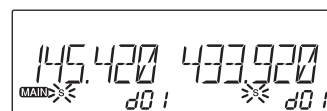

Skip and favorite channels setting

A memory channel set as skip-channels will be excluded from scanning during memory scan.

In contrary, if you have frequently monitoring channels, set them as Favorite for faster memory-scanning.

1. In the memory mode, select a memory channel to be skipped or set as a Favorite.
2. Press the FUNC key then press the V/M key while the [FUNC] icon is displayed. SKIP icon starts flashing.

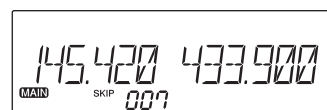

3. Rotate a dial to select either SKIP or ♥ for favorite. Press V/M key to save. The icon will stop flashing. Repeat above 2 again to cancel the setting. The icon will disappear.
4. Select SKIP or FAV in set mode menu 05 and perform the memory scanning.

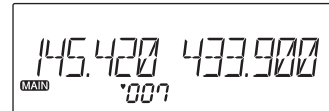

Programmed Scan

This is a type of VFO scan, and scans only the designated frequency range of the VFO sets into the P*A and P*B channels. This feature is referred to as "Search" and can be set 5 pairs in each band.

This program scan will operate under VFO setting, regardless of memory setting of the P*A/P*B memory setting.

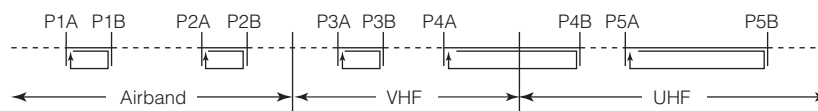

1. Enter the VFO mode and set the P○A and P○B frequencies into the designated memory channels. Refer to Memory setting P.23 for details. It doesn't matter which is higher and lower limits, but you should always make a pair to determine the edge of scanning range.
2. Return to the the VFO mode by pressing the V/M key of the band to be scanned.
3. Press FUNC key and while F icon is displayed, press the dial. PS- and a number appears.
4. Rotate the dial or UP/DOWN keys on the microphone to select a pair number. Press the dial to start scanning.
5. Press any key other than the UP/DOWN keys to stop.

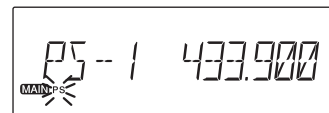

Program Scan is going



Programmed scan can't be performed in both bands at the same time.

Priority Scan

This is to monitor a priority channel for 0.5 second once every 5 seconds.

When a signal is being received in priority channel, monitors it for 2 more seconds.

This feature is available and programmable only by using the Clone utility provided by Alinco for free (an optional PC connection cable required).

1. **Use the cloning software to program frequency. For details please refer to the instruction manual of the utility software.**
2. **To start priority scanning, press dial knob while pressing FUNC key. To stop scanning press any key on monitoring side or press PTT. [S] icon will disappear.**

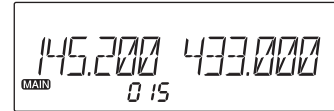

The receiving audio will be intermittent due to monitoring the priority channel. This is a common feature for commercial-use radios but not amateur radio for this reason, so this function is accessible only through the utility software. In case squelch is left open, it monitors the priority channel for 2 seconds every time.

Tone Scan

This function automatically searches for the CTCSS tone an incoming signal might carry. This feature is useful to search for the encoding tone of a repeater, or to communicate with a station operating in TSQ (CTCSS squelch) mode.

1. **Press FUNC then ★ key to enter the tone setting in the band you wish to tone-scan. Press ★ to display T and SQL icons. Press and hold the dial of the same side until the scan starts. Pressing UP/DOWN keys until start scanning and release immediately also activates the tone-scan. Display flashes while scanning.**
2. **It stops scanning when a matching tone is detected, and decoded signal will be heard. Press any key other than UP/DOWN to stop scanning. Press any key again to exit from tone-scan.**

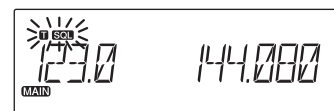
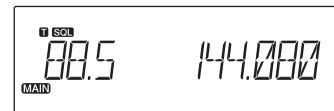

DCS Scan

This function automatically searches for the DCS tone an incoming signal might carry. This feature is useful to search for the encoding tone of a repeater, or to communicate with a station operating in DCS (Digital Code Squelch) mode.

- 1. Press FUNC then ★ key to enter the tone setting in the band you wish to DCS-scan. Press ★ to display DCS icon. Press and hold the dial of the same side until the scan starts. Pressing UP/DOWN keys until start scanning and release immediately also activates the DCS scan. Display flashes while scanning.**
- 2. It stops scanning when a matching code is detected, and decoded signal will be heard. Press any key other than UP/DOWN to stop scanning. Press any key again to exit from DCS scan.**

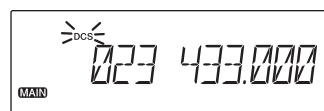

Key-Lock

This will lock the keys to avoid unintentional key operations.

- 1. Press and hold H/L key.**
The [On] icon appears on the display.
- 2. Repeat above to unlock.**
- 3. All keys and dial functions will remain locked except below in Key lock state.**
PTT
H/L key to cancel this function
Squelch and volume
UP/DOWN keys

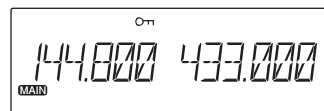

Short-Cut key

Various functions can be assigned to ★ key. You may assign one of set mode menu to ★ key to short-cut to the desired parameters.

1. **Enter to set mode and select desired menu.**
2. **Press and hold ★ key until a beep is heard. When this function is activated ☆ appears on the display.**
3. **★ key operates on both VFO and memory modes. Simply press the ★ key to access the assigned menu.**
4. **To reassign a new menu to ★ key, repeat above 1 and 2 so the ☆ disappear. Repeat 1 and 2 again with a new menu.**

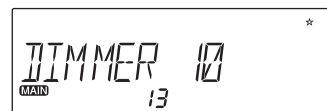

RGB color setting

This is to select the display illumination color. A total of 16 color-channels, 10 standard CL0 to CL9 and 6 user setting CLA to CLF, are available.

- CL0 to CL9 color-channels can be modified but color memory channel cannot be deleted.
- CLA to CLF color-channels are user-customs, and don't appear on the display at default. To delete the registered channels, select the last channel then press and hold left dial. You can't select a specific one, nor all together to delete.
- Refer to the set mode menu 10-12 to assign created colors here to Stand-by, RX and TX.
- RGB color reset is available. (P.75)

1. **In the VFO or memory mode, Press ★ key while pressing and holding FUNC key.**

The current color memory channel and its RGB values are displayed.

- Rotate the left dial to select a desired color memory channel to edit.
- At default, only CL0 ~ CL9 and CLA will be displayed.
- CLA ~ CLF will be displayed once programmed. Programmed ones stay lit, while unprogrammed ones flash. Only the last unprogrammed channel is displayed always.



2. **Rotate the right dial or UP/DOWN keys to adjust RGB values as you like. Press the right dial to switch R,G and B parameters. The adjustable parameter flashes. The change affects immediately. The color is determined with the total combination of R,G and B value so changing only 1 value may not change the color drastically.**

3. **Press the left dial to save, press any key other than dials, UP/DOWN key to exit.**

When the new value is saved:

- CL0 ~ CL9 overwrites the old value.
- Flashing CLA ~ CLF channels will stay lit and shows the programmed channels by rotating the dial.

To exit without saving , simply press FUNC key. A beep is heard and returns to operating mode.

Detailed instruction will be available for downloads from ALinco.com web site.

Selective Communication

Many repeaters require a CTCSS tone or a DCS encode setting as a “key” to access a repeater system, or a receiver using CTCSS or DCS squelch, so called “selective-calling”. Sometimes, CTCSS or DCS decode features are used on the output of a repeater so they can be used to open a squelch. In this mode, regardless of the main squelch status, the audio can be heard ONLY when the matching tone/code signal is received. The combination of CTCSS squelch and DCS function is not available; only one or the other may be used for given frequency.

CTCSS encoding, Tone-squelch and DCS operations

1. **In the VFO mode, set the operating band to MAIN. Press the FUNC key then press ★ key while [FUNC] appears on the display.**

The current tone frequency will be displayed. Repeat pressing ★ key to select the setting mode as below:

[T] CTCSS encoding: Transmits CTCSS encoding tone for repeater accesses.

[T][SQL] CTCSS encoding and decoding tones. Tone squelch operation is possible.

[DCS] DCS operation is possible. In DCS, both encoding and decoding tones are the same.

Press any key except ★ key to complete and return to operating mode. T/TSQL/DCS icons remains displayed.

The same operation is possible in the memory mode but temporary. Channel and power operation will delete setting.

2. **In above [T] , use Dial or UP/DOWN keys to select tone-encoding frequency. This value will apply automatically to the next decoding tone. In [TSQL], operating dial or UP/DOWN keys select the decoding frequency only. This is for a special application and conventional repeaters don't require to separate encoding and decoding tones.**

3. To cancel tone operations, repeat above 1 and select OFF. Icons will disappear.

See the below charts for available 39 CTCSS tones and 105 DCS tones.



NOTE

DET operation in DCS

In case DCS squelch is instable, while DCS icon is displayed, press H/L key. A dicimal point at MHz order will appear. Press any key except ★ key to complete and return to operating mode. This setting can be stored in memory channels.

In DET mode, once the squelch is opened by matching DCS tone, the squelch will remain opened regardless of the presence of the DCS tone afterwards.

This means you risk hearing unwanted signals.

CTCSS chart (Hz):

| | | | | | | | |
|-------|-------|-------|-------|-------|-------|-------|-------|
| 67.0 | 69.3 | 71.9 | 74.4 | 77.0 | 79.7 | 82.5 | 85.4 |
| 88.5 | 91.5 | 94.8 | 97.4 | 100.0 | 103.5 | 107.2 | 110.9 |
| 114.8 | 118.8 | 123.0 | 127.3 | 131.8 | 136.5 | 141.3 | 146.2 |
| 151.4 | 156.7 | 162.2 | 167.9 | 173.8 | 179.9 | 186.2 | 192.8 |
| 203.5 | 210.7 | 218.1 | 225.7 | 233.6 | 241.8 | 250.3 | |

DCS chart:

| | | | | | | | | | | | |
|-----|-----|-----|-----|-----|-----|-----|-----|-----|-----|-----|-----|
| 023 | 025 | 026 | 031 | 032 | 036 | 043 | 047 | 051 | 053 | 054 | 065 |
| 071 | 072 | 073 | 074 | 114 | 115 | 116 | 122 | 125 | 131 | 132 | 134 |
| 143 | 145 | 152 | 155 | 156 | 162 | 165 | 172 | 174 | 205 | 212 | 223 |
| 225 | 226 | 243 | 244 | 245 | 246 | 251 | 252 | 255 | 261 | 263 | 265 |
| 266 | 271 | 274 | 306 | 311 | 315 | 325 | 331 | 332 | 343 | 346 | 351 |
| 356 | 364 | 365 | 371 | 411 | 412 | 413 | 423 | 431 | 432 | 445 | 446 |
| 452 | 454 | 455 | 462 | 464 | 465 | 466 | 503 | 506 | 516 | 523 | 526 |
| 532 | 546 | 565 | 606 | 612 | 624 | 627 | 631 | 632 | 645 | 654 | 662 |
| 664 | 703 | 712 | 723 | 731 | 732 | 734 | 743 | 754 | | | |

Auto-dialer

This function is used to transmit a memorized DTMF codes, up to 16 digits in available characters (0 to 9/ABCD#*-). The autodialer memory should be set in advance to operate.

To Program the Auto-dialer:

1. **Press and hold FUNC key then press MW key.**
2. **Rotate left dial or press UP/DOWN keys to select an autodialer memory channel.**
3. **Rotate right dial to select a code, and push the right dial to save and move to edit next code. Press MW key to move left; the editing digit is displayed on the right beneath.**
Press and hold right dial to delete all codes.
4. **Press any key other than PWR, or dials to save and exit.**

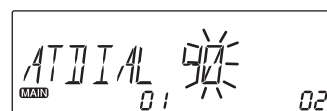
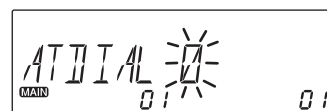

NOTE

- A pause is shown as [-].
- The shown codes will scroll toward left when excesses more than 6 digits.

Transmitting the stored Auto-dialer codes

1. **Select Auto-dialer channel.**
Press and hold FUNC key then press MW key. Rotate left dial or UP/DOWN keys to select an autodialer memory channel.
2. **While pressing and holding PTT, press UP key. Selected codes will be transmitted and the tones will be heard from the speaker.**

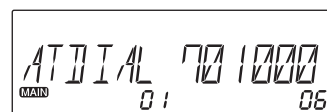

Digital voice communication

By installing an optional digital unit EJ-47U, digital voice communication becomes possible.

1. **Install EJ-47U to the connector of the unit as shown below. Below operation is not possible without EJ-47U installed.**

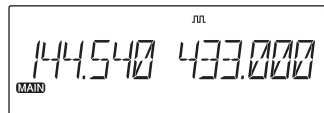

Digital mode operation

2. **Press the FUNC key, and then press the H/L key while the [FUNC] icon is displayed.**
 - [𠄎] appears on the display.
 - Digital voice communication is usable only on the right side band.
3. **To cancel the digital communication mode, repeat step2, [𠄎] will disappear.**

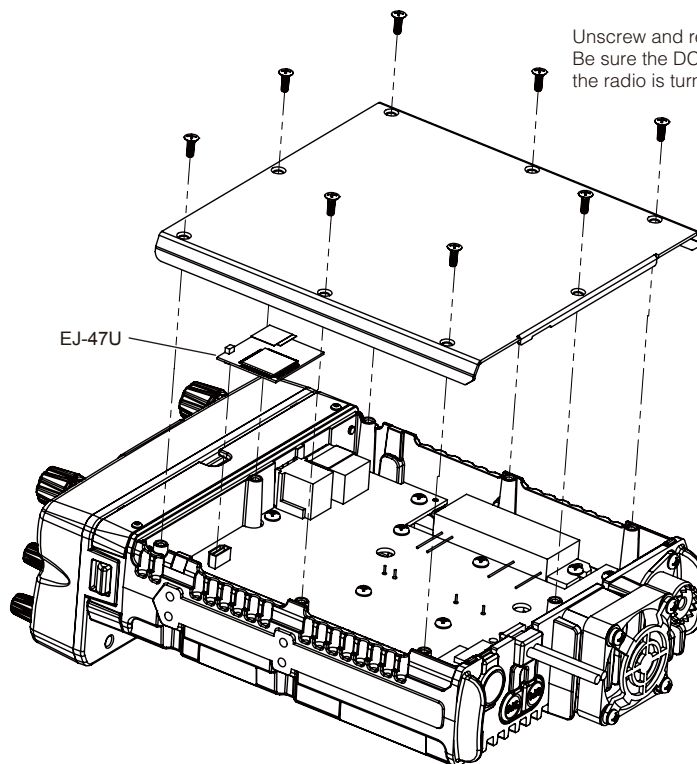

Unscrew and remove the bottom cover. Be sure the DC cable is removed and the radio is turned off.

IMPORTANT

- Digital voice operation on certain amateur radio frequencies may be prohibited, restricted or subject to a special station license. Please be sure to consult with your local authority prior to operating in this mode.
- The digital mode can't be operated when the packet mode is activated.

Cable clone function

This feature will copy the programmed data and parameters in the master unit to slave units. Refer to the picture below also to connect an optional ERW-7 to edit memories and settings by using the clone utility software.

■ Connection

Turn off the units. Make a connection between the master and slave units as shown below using a commercially available unloaded 3.5mm ϕ stereo-plug audio cable. To make a cable by yourself, refer the Plug configuration.

Turn on both units after the connection is completed.

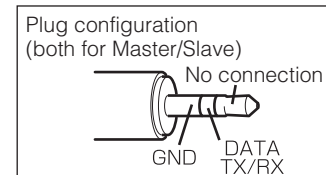

Use the same port for the ERW-7 connection to operate PC cloning. See the instruction of the utility software for details.

IMPORTANT Be certain to connect cables while the units are turned OFF.

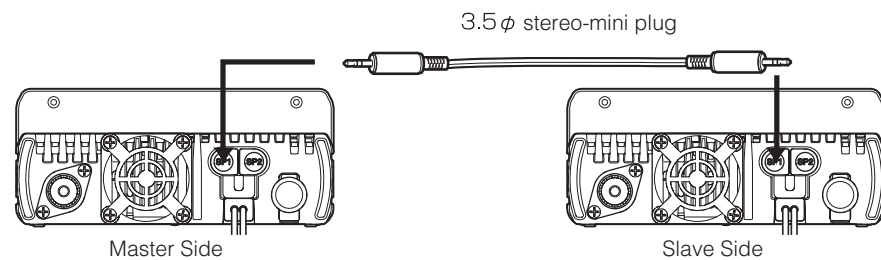

■ Setting on the Master side

1. **Press the FUNC key and then press and hold MW key while [FUNC] appears on the display. [CLONE SD0000] will be displayed and the radio enters the clone mode.**

This operation is also necessary to copy the data edited in the Clone utility software.

2. **Press PTT. [CLONE SD****] will be displayed and the master unit start sending data to the slave unit.**

The displaying codes will vary during data transferring.

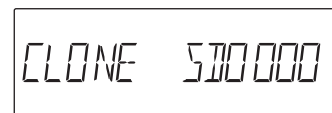

3. **[CLONE PASS] will appear on the display when the data has been successfully transmitted.**

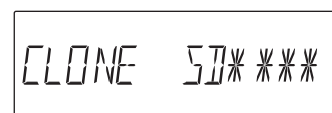

During transmission

4. **The master radio may stay turned on for the next clone. Turn off the unit to exit from the clone mode.**

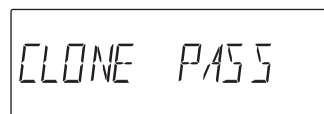

When transmission is finished

■ **Setting on the slave side**

1. **Turn on and set to VFO or memory mode.**

2. **Operate the master side; [CLONE LD****] appears as it starts receiving the cloning data.**

**** will change during data transferring.

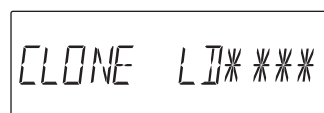

During transmission

3. **When the transmission is successfully finished, [CLONE PASS] appears.**

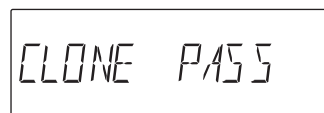

When transmission is finished

4. **Turn off power. Disconnect the cable and repeat above to clone the next slave unit.**

If the data is not successfully transmitted, turn off both units, make sure the cable connection is correct and repeat the entire operation from beginning.

IMPORTANT Never disconnected the cable while data is being transmitted in the clone mode.
It may cause damages to the radios.

XBR (Crossband Repeater) Mode / T-models only

This mode allows the DR735T to operate like a repeater using both VHF and UHF bands.

That is, when receiving a signal on one band, the radio automatically transmits the same signal on another band simultaneously.

XBR Mode operation

Set the bands to 145MHz and 440MHz, and select both frequencies within the transmitting range.

- Any combination of VFO, memory channels, or CALL channels can be set as receiving and transmitting frequencies provided they are 145/440MHz ham band combination.
- The XBR doesn't support digital modes such as packet and digital-voice.
- The XBR respects the offset shift, direction and selective calling tone settings.
- The TOT function is usable but TOT penalty-time and BCLO functions become deactivated during the XBR operation.
- When the DC current is cut, and comes back again, the radio turns on in XBR mode without power key operation.

To activate the XBR, turn off then press and hold the MW key while turning on the power.

XBR icons appear on the display. Repeat the same to exit from the XBR mode.

CAUTION

The radio becomes very hot while operating as a XBR. Use of an external, additional cooling fan is recommended especially when operating in high power.

Packet Communication

Following signals are available from the DIN socket on the rear panel for connection with an external device like TNC unit. You should activate the TNC output by referring to P.55 in advance.

■ Using external TNC unit

Connect mini DIN socket at the rear panel of radio to external TNC unit as shown.

Enter advanced set mode, select menu. 32 for TNC ON.

Connect pins 1,2,3 and 5 to external TNC unit and if necessary also connect pins 4 and 6.

Mini DIN socket configuration:

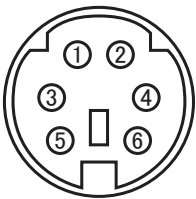
| Mini DIN socket | Configurations | DEFINITION |
|---|----------------|---|
|  | 1.DATA IN | Packet communications DATA input (1200bps), Max 4800bps |
| | 2.GND | Ground for DATA IN, DATA OUT and AF OUT |
| | 3.PTT | PTT switch, connect to ground for transmitting |
| | 4.DATA OUT | Packet communications DATA output, Data output for 9600bps received signal (500mVp-p) |
| | 5.DATA OUT | Packet communications DATA output, Data output for 1200bps received signal (500mVp-p) |
| | 6.SQL | Squelch output. SQL open: 0V SQL close: 5V |

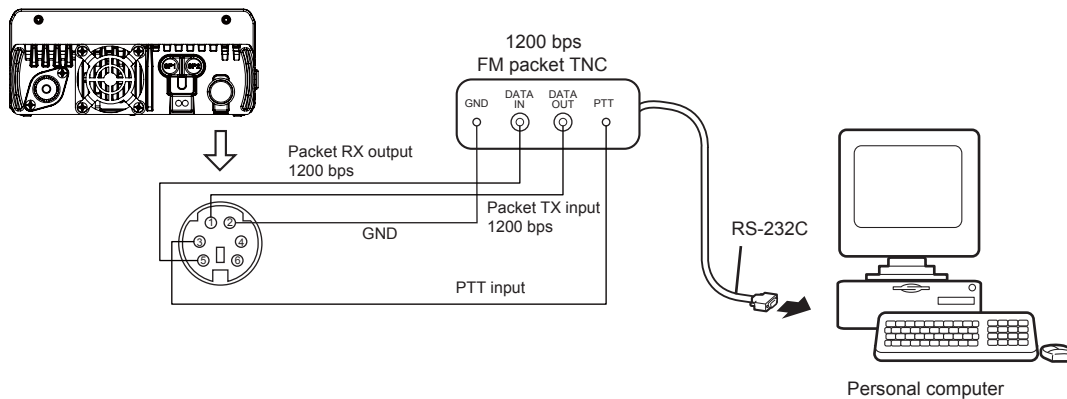

IMPORTANT

Maximum transmission speed is 4800 bps. Maximum reception speed is 9600 bps. TNC mode can be activated only on the right band.

Remote Control Operation (EMS-79 Only)

The radio can be controlled remotely by operating the DTMF keys on the microphone. Frequencies can also be entered directly through the key pads.

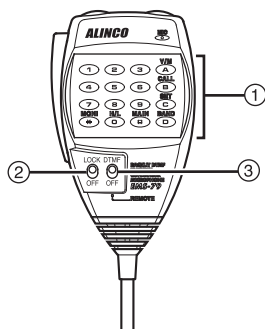

| No. | Key | Function |
|-----|----------|--|
| ① | DTMF | Enter the remote command or the frequency. |
| ② | LOCK | Only PTT becomes active by locking other keys. |
| ③ | DTMF/OFF | Select OFF to operate remote control, |

■ List of Remote Control Keys

| Key | Radio corresponding key | Function | Page |
|-----|-------------------------|-------------------------------|------|
| 0-9 | - | Direct frequency input | - |
| A | V/M | Memory channel access | 23 |
| B | Press and hold V/M | Call channel access | 30 |
| C | Press and hold FUNC | SET mode access (Note1) | 34 |
| D | Press and hold VOL Knob | Switching bands | 19 |
| * | FUNC then MW | Monitor function | 31 |
| # | VOL Knob | Switching MAIN band | 19 |
| 0 | H/L | Switching transmission output | 33 |

IMPORTANT There is no SUB PTT switch on the EMS-79 microphone.

To select the set mode menu, press the UP and DOWN keys at the top. To select parameters of the left band, press the * and 0 keys. For the right band press the # and D keys. Press PTT key or C key to save and exit.

■ Entering a frequency directly

Frequencies can be entered directly by pressing the numerical keys of the microphone.

1. **Set the DTMF/OFF switch to the OFF position.**
2. **Press numerical key to enter desired frequencies from 100MHz to 1KHz in order. Only 1 and 4 are accepted as the first digit.**

When an incorrect frequency is entered, it will be rounded off to the nearest available one.

Be sure the channel step is correct to enter the desired frequency.

A beep is heard and the entered frequency is displayed. Press PTT while entering the frequency to cancel the operation.

(Ex.) When setting 144.20 MHz with the turning step set to 20 KHz.

Enter 1 4 4 2 0 0

After entering the last digit a beep is emitted and the entry is completed.

To cancel an entry before it is completed, press the PTT key.

Mic. Connector Diagram (While looking in the front view of the connector)

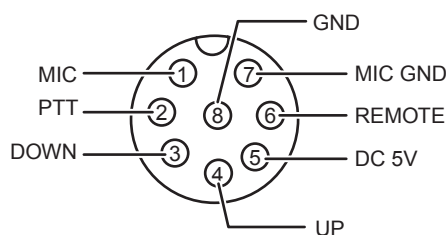

Maintenance / Reference

Reset

Different reset features are available in DR-735. Please read carefully before you perform them. By using restore function most setmode setting will be restored and recalled, but memory channel data are erased. Use Clone utility to save the memory channel data.

Basic Reset

This is to reset setting of VFO, setmode and advanced setmode parameters. Most key operation functions will return to default conditions.

1. Turn on the radio by pressing PWR key while pressing FUNC key.
2. All segments of the LCD will be displayed and reset is completed.

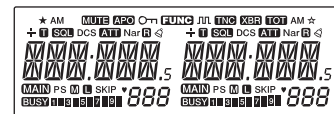

All LCD segments

VFO Reset

This is to reset only VFO mode setting. All parameters in set mode and memory data will remain.

1. Turn on the radio by pressing PWR key while pressing left V/M key.
2. All segments of the LCD will be displayed and VFO reset is completed.

Memory Reset

This is to reset only memory data. All parameters in set mode and VFO frequency will remain.

1. Turn on the radio while pressing right V/M key.
2. INIT DATA will be displayed and memory reset is completed.

RGB Reset

This is to reset user setting display color (CL0 ~ CL9, and to delete CLA ~ CLF channels).

1. Turn on the radio by pressing PWR key while pressing right V/M and ★ key together.
2. All segments of the LCD will be displayed and RGB reset is completed.

All Reset

This is to reset radio to factory default setting (except restored data in restore setting). All above resets will be performed at once.

1. Turn on the radio by pressing PWR key while pressing MW, H/L and ★ key together.
2. All segments of the LCD and INIT DATA will be displayed and All reset is completed.

Troubleshooting

Please check the list below before concluding that the radio is faulty.

If a problem persists, reset the radio. This can sometimes correct erroneous operation.

| Problem | Possible Causes | Potential Solutions |
|--|--|--|
| Can't turn on the power. | a. + and – polarities of power connection are reversed. b. Fuse is blown. c. Power supply or DC/DC convertor is not turned on. | a. Correctly connect the red lead and the black lead of the DC power cable respectively to the terminals. b. Check and solve the problem resulting in blown fuse and replace it with a new one with the same rated capacity. c. Turn on the power supply or DC/DC convertor. |
| Display is too dim. | Dimmer setting level is low. | Make the dimmer level setting higher. |
| No sound comes from the speaker. The unit does not receive. | a. Audio level is too low. b. Squelch is muted. c. Tone or DCS squelch is active d. PTT key of the microphone is pressed for transmission. e. External speaker is defective. | a. Set the volume knob properly. b. Decreases squelch level. c. Turn tone or DCS squelch off. d. Immediately release PTT switch. e. Remove and inspect the speaker. |
| Keys and the dial do not function. | Key-lock function is activated ([OK] is on). | Cancel key-lock function. |
| Rotating the dial will not change memory channel. | a. No memory is programmed. b. The unit is in CALL mode. | a. Program memory channels. b. Press V/M key to cancel CALL mode. |
| Pressing the UP/DOWN key will not change frequencies or memory channels. | a. The unit is in CALL mode. b. Lock switch on the microphone is ON. | a. Press V/M key to cancel CALL mode. b. Turn off the lock switch on the microphone. |
| PTT pressed but doesn't transmit. It transmits but can't communicate. | a. Microphone terminal is not properly inserted. b. Antenna is not connected. c. [OFF] appears on the display. | a. Properly insert the microphone connection. b. Properly connect the antenna. c. Cancel SHIFT or set within the band. d. Transmit inside transmission range. |

■ Noise

- When reception frequencies fall in any one of the formula below, the unit may receive a non-modulated signal.
This is due to the structure of frequencies of this unit and not a malfunction.
(Reception frequency on the left side VHF band – 21.7MHz) X 3 = UHF reception frequency on the right side)
(Reception frequency on the left side UHF band – 21.7MHz) X 3 – (VHF reception frequency on the right side + 30.85MHz) X 7 = 30.85 MHz
- When reception frequency is 3 times bigger than transmission frequency, transmitted voice will be heard and [FREQ X3] appears on the display.



NOTE

Alinco guarantees the supply of minimum-necessary spare parts such as microphones, components and mechanical parts for at least 5 years after the production of this product is terminated except in case of accidents beyond control.

■ Demonstration mode

This is for showcase purposes and display shows characters and different colors automatically.

Turn the dial while in the demo mode to operate, and leave it for 10 minutes without operating to return to the demo mode. Key lock then turn off the power. Turn on with MW and H/L key pressed together to enter.

Turn off the power in demo mode, turn on with MW and H/L key pressed together to exit.

Optional accessories

- EMS-79 DTMF microphone

* No sub PTT on this model.

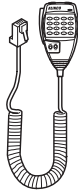

- EMS-78 microphone

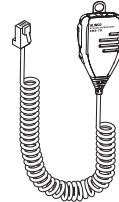

- EJ-47U Digital voice communication unit
- EDS-30 Separation kit (5m cable + bracket + hardware)
- EDS-8 microphone conversion cable (8 pin to modular)
- ERW-7 PC connection cable

EDS-30 (Optional) Installation

Be certain to turn off the radio before installation.

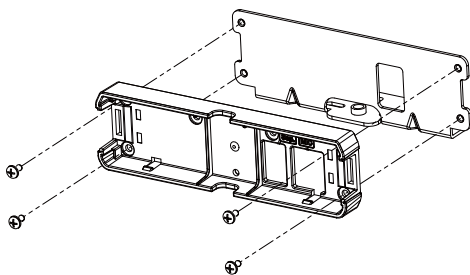

Fix panels with screws.

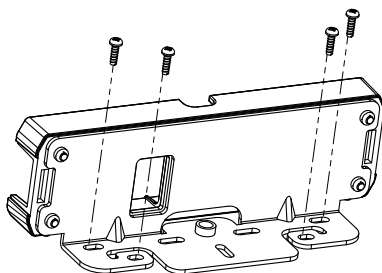

Install the panel with screws.
Make sure the position before to screw.

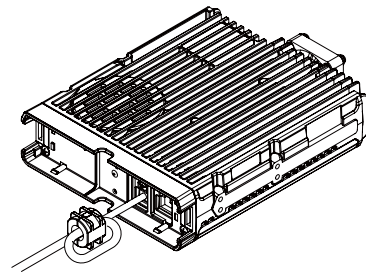

Insert the cable to the smaller connector on the left marked SEP.

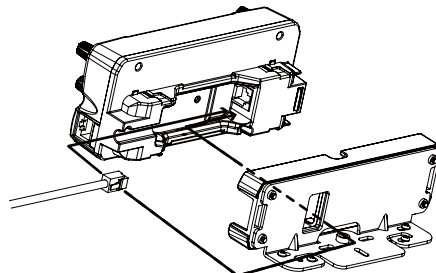

Insert another end of cable to the connector on the back of the front control unit.

IMPORTANT

Never place the plug to the connector on the right of the front control unit. It is for the microphone, and doing so may cause damage to the unit and/or the microphone.

Specification

| General | | |
|-------------------------------|----------|---|
| Frequency coverage DR-735T | VHF | 108.000 ~ 135.995MHz (RX) 136.000 ~ 173.995MHz (RX) 144.000 ~ 147.995MHz (TX) |
| | UHF | 400.000 ~ 479.995MHz (RX) 430.000 ~ 449.995MHz (TX) |
| Frequency coverage DR-735E | VHF | 108.000 ~ 135.995MHz (RX) 136.000 ~ 173.995MHz (RX) 144.000 ~ 145.995MHz (TX) |
| | UHF | 400.000 ~ 479.995MHz (RX) 430.000 ~ 439.995MHz (TX) |
| Operating mode | | 16K0F3E (Normal mode) 8K50F3E (Narrow mode) |
| Frequency resolution | | 5, 6.25, 8.33, 10, 12.5, 15, 20, 25, 30, 50, 100KHz |
| Number of memory channels | | 1000ch+100ch(dual) |
| Antenna impedance | | 50Ω unbalanced |
| Power requirement | | 13.8V DC ±15% (11.7 to 15.8V) |
| Ground method | | Negative ground |
| Current drain | Receive | 0.6A (Max.) 0.4A (Squelched) |
| | Transmit | 12.0A |
| Operating temperature | | -10°C to 60°C |
| Frequency stability | | ±2.5ppm |
| Dimensions | | 140 (w)×Front: 60 Body: 40 (h)×188(d) mm |
| Weight | | Approx. 1.3kg |

Transmitter

| | |
|-----------------------------|---|
| Output power | High: 50W Mid : 20W Low : 5W |
| Modulation system | Variable reactance frequency modulation |
| Maximum frequency deviation | ±5kHz (Wide mode) ±2.5kHz (Narrow mode) |
| Spurious emission | -60dB |
| Adjacent channel power | -60dB |
| Noise and hum ratio | -40dB (Wide mode) -34dB (Narrow mode) |
| Microphone impedance | 2kΩ |

Receiver

| | | |
|------------------------------------|------------------------------------|-------------------------|
| Sensitivity | -16dBu for 12dB SINAD | |
| Receiver circuitry | Double conversion super heterodyne | |
| Intermediate frequency | VHF MAIN UHF SUB | 1st 21.7MHz 2nd 450kHz |
| | UHF MAIN VHF SUB | 1st 30.85MHz 2nd 455kHz |
| Squelch sensitivity | -18dBu | |
| Selectivity (-6dB/-60dB) | 12kHz/24kHz | |
| Inter modulation rejection ratio | 60dB | |
| Spurious and image rejection ratio | 70dB | |
| Audio output power | >2.0W (8Ω,10%THD) | |

All specifications are subject to change without notice or obligation.

Details of frequency / steps in AUTO mode

| | Lower limit in MHz | Upper limit in MHz | Step | Mode |
|---|--------------------|--------------------|---------|------|
| T | 108.000 | 136.000 | 25KHz | AM |
| | 136.000 | 144.000 | 5KHz | FM |
| | 144.000 | 174.000 | 12.5KHz | FM |
| | 400.000 | 450.000 | 5KHz | FM |
| | 450.000 | 480.000 | 12.5KHz | FM |
| E | 108.000 | 136.000 | 5KHz | AM |
| | 136.000 | 142.000 | 25KHz | FM |
| | 142.000 | 156.000 | 12.5KHz | NFM |
| | 156.000 | 158.500 | 25KHz | FM |
| | 158.500 | 174.000 | 12.5KHz | NFM |
| | 400.000 | 446.000 | 12.5KHz | NFM |
| | 446.000 | 480.000 | 6.25KHz | NFM |

[MEMO]

ALINCO,INC.

Head Office: Yodoyabashi-Dai Building 13th Floor
4-9, 4-Chome, Koraihashi, Chuo-ku, Osaka 541-0043, Japan
Phone: +81-6-7636-2362 Fax: +81-6-6208-3802
<http://www.alinco.com/>
E-mail: export@alinco.co.jp



Printed in Philippines
Copyright Alinco, Inc. PS0867
FNEJ-NH